

---

# Luminoscope® PRO SLA 40

---

## Quick start guide [Latest version 20260626]

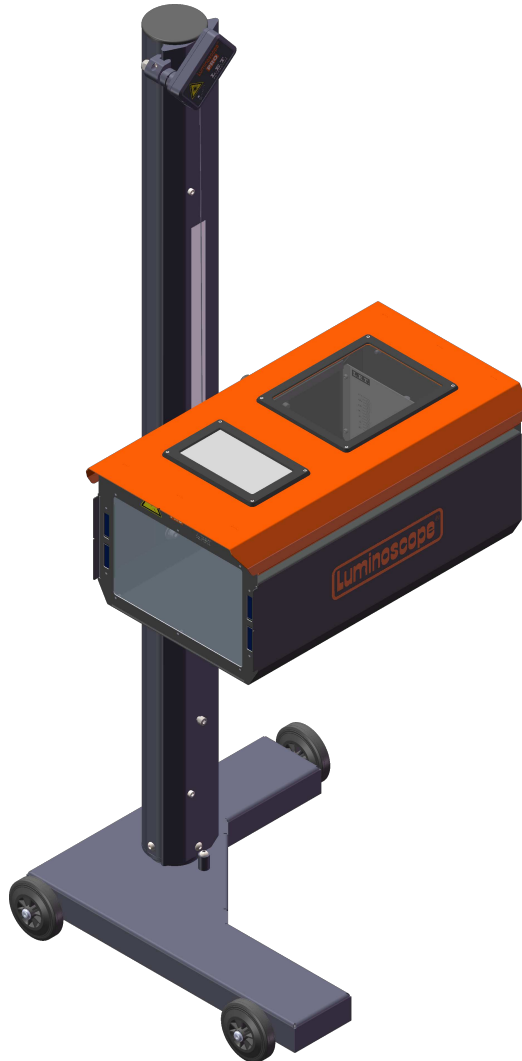



---

# Considerations

---

## Copyright, disclaimer and notes clarification

### Copyright

---

No part of this documentation may be reproduced, stored in a retrieval system, or transmitted in any means, electronic, mechanical, photocopying, recording or otherwise, without the prior written permission of LET Automotive NV.

### Disclaimer

---

Every care has been taken by the staff of LET Automotive NV in the compilation of the data contained herein and in the verification of its accuracy when published, however the content of this manual is subject to change without notice due to factors outside the control of LET Automotive NV and this manual should, therefore, be used as a guide only. For example, the products referred to in this publication are continually improved through further research and development and this may lead to information contained in this manual being altered without notice.

This manual is published and distributed on the basis that LET Automotive NV is not responsible for the results of any actions taken by users of information contained in this manual, nor for any error in or omission from this manual. LET Automotive NV does not accept any responsibility whatsoever for misrepresentation by any person whatsoever of the information contained in this manual and expressly disclaims any liability and responsibility, in respect of claims, losses or damage or any other matter, either direct or consequential arising out of or in relation to the use and reliance, upon any information contained or products referred to in this manual.

### Notes clarification

---

LET Automotive products are manufactured for use according to proper procedures by a qualified operator and only for the purposes described in this manual.

The following icons are displayed to indicate additional information that may have added value to the specific topic or is qualified as a precaution measure. Always pay attention to the included information.



**Warning:** Indicates a potential hazardous situation which, if not taken into account, could result in damage or problematic functioning of the device. In some cases, it could also lead to physical injuries.



**Attention:** Indicates important information of particular interest for an efficient and convenient operation of the product. Not taking this information into account could result in damage on problematic functioning of the device or its intended use.



**Note:** Indicates information of interest for efficient and convenient operation of the product or indicates just additional information on the topic.



# Table of Contents

<b>1 Regulations.....</b>	<b>9</b>
1.1 Safety regulations.....	9
1.2 Danger of localized heating.....	9
1.3 Environmental regulations.....	10
<b>2 Basic Principles.....</b>	<b>11</b>
2.1 Headlamp criteria.....	11
2.2 Adjusting headlamps.....	11
2.3 Lens Principle.....	13
2.4 Advantages of optical block with lens.....	13
2.5 Image processing.....	14
2.6 Alignment with the vehicle.....	16
2.7 Positioning in front of the headlamp.....	19
<b>3 Headlamps.....</b>	<b>21</b>
3.1 ECE or European low beam.....	21
3.2 High beam.....	22
3.3 Fog beam.....	23
3.4 SAE or American low beam.....	24
3.5 Japanese low beam.....	25
3.6 Dynamic headlamps and intelligent lighting systems.....	26
3.6.1 Glare free high beam with beam motorisation.....	26
3.6.2 Glare free high beam with multiple static LED sources.....	27
3.6.3 Dynamic low beam.....	28
<b>4 Prerequisites for checking or adjusting.....</b>	<b>31</b>
4.1 Prerequisites for the vehicle.....	31
4.2 Prerequisites for the headlamps.....	31
4.3 Positioning the system.....	31
<b>5 Technical characteristics.....</b>	<b>33</b>
5.1 SLA 40 models.....	33
5.2 Guiding systems.....	36
5.2.1 SLA 40 DR: double rail.....	37
5.2.2 SLA 40 SR: single rail.....	37
5.2.3 SLA 40 NR: no rail.....	38
5.3 Layout.....	38
5.3.1 Front view.....	39
5.3.2 Top view.....	40
5.3.3 Left side view.....	44
5.3.4 Right side view.....	46
5.3.5 Rear view.....	47
5.3.6 Alignment laser.....	48
5.4 Dimensions.....	49
5.4.1 SLA 40 DR.....	49
5.4.2 SLA 40 SR.....	50
5.4.3 SLA 40 NR.....	51
5.5 Datasheet.....	52

<b>6 Power management</b>	<b>55</b>
6.1 Switching the Luminoscope® ON and OFF	55
6.2 Power standby	56
6.3 Inactivity timer	56
6.4 Forced shut down of the Luminoscope®	56
<b>7 Operation</b>	<b>59</b>
7.1 Test cycle references	59
7.1.1 Beam icons	59
7.1.2 Left / right vehicle side definition	61
7.1.3 Alignment with the vehicle	62
7.1.3.1 Alignment laser	63
7.1.3.2 Linear alignment	64
7.1.4 Positioning in front of the headlamp	65
7.1.5 Mounted height of the headlamp	66
7.1.5.1 Standard definition	66
7.1.5.2 For DVSA units	70
7.1.6 ESL - Electronic Spirit Level module	74
7.2 Test cycle sequence	75
7.2.1 Switching on the Luminoscope®	76
7.2.2 Alignment with the vehicle	77
7.2.3 Alignment with the vehicle for units fitted with optional bolt-aligner	77
7.2.4 Program selection	78
7.2.4.1 Program list	78
7.2.4.2 Program selection buttons (Standard)	79
7.2.4.3 <b>Program selection</b> screen for UK market	80
7.2.5 Line selection	80
7.2.6 Beam selection	82
7.2.6.1 Free beam selection sequence	82
7.2.6.2 Fixed beam selection sequence	83
7.2.7 Selection of mounted headlamp height	85
7.2.8 Positioning in front of the headlamp	85
7.2.9 ESL (Electronic Spirit Level) module compensation	87
7.2.10 Beam measurement	87
7.2.10.1 Low beam test	88
7.2.10.2 High beam test	92
7.2.10.3 Fog beam test	95
7.2.11 Beam measurement results	96
7.2.12 Test cycle reports and data transmission	97
7.2.12.1 Test report as a PDF file	98
7.2.12.2 Test report as printed ticket	99
7.2.12.3 Test results transfer to the host computer (communication protocols)	101
7.3 OEM test cycle sequences	101
7.3.1 ECE-VAR low beam sequence	105
7.3.1.1 Summary of the test sequence	106
7.3.1.2 Test sequence	106
7.3.2 ECE - 15°/45° low beam sequence	110
7.3.2.1 Summary of the test sequence	111
7.3.2.2 Test sequence	112
7.3.3 MDF high beam sequence	116
7.3.3.1 Summary of the test sequence	117
7.3.3.2 Test sequence	118
7.3.4 PIXEL 90 low beam sequence	122
7.3.4.1 Summary of the test sequence	124
7.3.4.2 Test sequence	125
7.3.5 VW/AUDI Matrix high beam sequence	130
7.3.5.1 Summary of the test sequence	132
7.3.5.2 Test sequence	132
7.3.6 VW/AUDI Matrix 2.0 high beam sequence	138
7.3.6.1 Summary of the test sequence	140

7.3.6.2 Test sequence.....	141
7.3.7 SKODA <i>Matrix</i> high beam sequence.....	147
7.3.7.1 Summary of the test sequence.....	149
7.3.7.2 Test sequence.....	150
7.3.8 Renault <i>Matrix</i> high beam sequence.....	162
7.3.8.1 Summary of the test sequence.....	163
7.3.8.2 Test sequence.....	164
7.3.9 VOL <i>American</i> low beam sequence.....	168
7.3.9.1 Summary of the test sequence.....	170
7.3.9.2 Test sequence.....	170
7.3.10 VOR <i>American</i> low beam sequence.....	173
7.3.10.1 Summary of the test sequence.....	175
7.3.10.2 Test sequence.....	175
7.4 Matrix headlight mode.....	178
7.4.1 Test cycle sequences.....	179
7.4.1.1 Aiming cycle.....	181
7.4.1.2 Measurement cycle.....	184
<b>8 Navigation map.....</b>	<b>187</b>
Program selection screen.....	187
System screen.....	187
Setup login screen.....	188
Setup screen.....	188
Computer configuration screen.....	189
Settings program screen.....	189
Verification screen.....	190
Calibration screen.....	190
<b>9 System screen.....</b>	<b>191</b>
9.1 Luminoscope® turn off or restart.....	192
9.2 Language selection.....	194
9.3 System information.....	195
9.4 Reprint last test result.....	197
9.5 Recall recent test results.....	197
9.6 Import / export of data via <i>USB</i> stick.....	199
9.6.1 Export operations: Luminoscope® to <i>USB</i> stick.....	201
9.6.1.1 Export of a configuration file.....	201
9.6.1.2 Export of test result files.....	204
9.6.1.3 Export of log files.....	209
9.6.1.4 Export of a configuration file of vehicles and headlamps.....	213
9.6.2 Import operations: <i>USB</i> to Luminoscope®.....	213
9.6.2.1 Import of a configuration file.....	213
9.6.2.2 Software update from a <i>USB</i> stick.....	213
9.6.2.3 Import of a <i>license token file</i> .....	213
9.6.2.4 Import of a configuration file of vehicles and headlamps.....	214
<b>10 Setup screen.....</b>	<b>215</b>
<b>11 Computer configuration screen.....</b>	<b>221</b>
11.1 Date and time setup.....	223
11.1.1 Manual date and time setting.....	224
11.1.2 Automatic date and time setup.....	225
11.2 <i>WiFi</i> networking.....	226
11.2.1 <i>WiFi</i> applications.....	229
11.2.2 Local Access Point setup.....	230
11.2.3 Regular mode setup.....	230
11.3 <i>Ethernet</i> networking.....	235

11.3.1 <i>Ethernet</i> applications.....	237
11.3.2 Ethernet setup.....	238
<b>12 Web interface.....</b>	<b>241</b>
12.1 Access to the <i>web interface</i> .....	242
12.2 Upload a customer logo for the <i>PDF</i> test reports.....	244
12.3 Check and/or print the <i>PDF</i> test reports.....	245
12.4 Export the configuration file of the Luminoscope®.....	247
12.5 Check and/or modify some settings of the Luminoscope®.....	248
12.6 Check stored info and remotely operate the Luminoscope®.....	249
12.6.1 Access to log files.....	251
12.6.2 Access to camera images.....	252
12.6.3 Access to screenshots.....	253
12.6.4 Access to remote Luminoscope® screen.....	254
<b>Personal notes.....</b>	<b>257</b>

---

# 1 Regulations

---

Read these instructions before using or powering up the Luminoscope® system.

## 1.1 Safety regulations

This headlamp tester complies with the necessary safety regulations.

- Improper use or handling of the appliance can compromise the safety of the operator and the environment, as well as the reliability of the measurement.
- Repairs may only be done by the Service engineers of *LET Automotive*. Inexpert repairs can result in danger to the operator and environment.
- Repairs and/or spare parts exchange may only be done with units which are delivered by *LET Automotive*.

Besides the above-mentioned safety regulations, the following must also be observed:

- Damaged electrical cables of the appliance or the charging adaptor must immediately be replaced.
- Damaged steel wires on the vertical sliding table must immediately be replaced.
- Only use the supplied 12 VDC/60 W adaptor to charge the battery of the optical block.
- Only use the handle of the vertical sliding table to move the system. Do not move the system by pulling or pushing other parts (alignment device, optical block, etc.).
- Do not put or hang objects on the appliance (tools, clothes, etc.).
- Make sure the wheels of the base are always clean. Obstructions on the rails or wheels can bring the system off-balance during a movement.
- The appliance is not waterproof. Keep it safely out from water spills, soaking or submersion into water and any other liquid.
- The appliance is not shock-proof. Protect it against heavy shocks or impacts. Do not drop or let it fall.

## 1.2 Danger of localized heating

### Warning:



- During the seasons of the year when the sun is very low in the sky, there is a risk of the sun shining directly into the collecting lens of the Luminoscope®, so that the focusing effect which is used to complete the headlights tests may cause focalized overheating inside the machine.
- The generated heating may in extreme cases severely damage the Luminoscope®!
- To avoid any possible damage, it is strongly recommended that the dust/sun cover is used whenever the Luminoscope® is not operational.

## 1.3 Environmental regulations



### Warning:

- Be aware of the consequences of incorrect waste disposal.
- Incorrect disposal of recoverable materials may negatively impact the environment.
- When the service life of the Luminoscope® expires, the appliance should not be discarded with normal household waste. It should be offered for recycling according to the local currently valid regulations instead.

The following materials are used for the main parts of the Luminoscope® SLA 40:

Part	Material
Fresnel lens	Polymethyl methacrylate (PMMA)
Stand	Aluminium
Optical block	Steel
Base	Steel
Alignment laser	ABS case, aluminum mounting and steel shaft
Battery in optical block	LiFePO <sub>4</sub> (or Lithium-ion) cells
Battery in alignment laser	2x LR6 (AA) standard single-cell, professional use

---

# 2 Basic Principles

---

What follows is a general explanation of the principles involved in the design and use of Luminoscope® devices and their environment.

## 2.1 Headlamp criteria

During an international conference in Vienna in 1958, it was agreed that the headlamps on vehicles should comply with the following criteria:

- A high beam should illuminate the road in front of the vehicle for at least 100 m (300 ft).
- A low beam should illuminate the road in front of the vehicle for at least 40 m (120 ft) without blinding the oncoming vehicles.

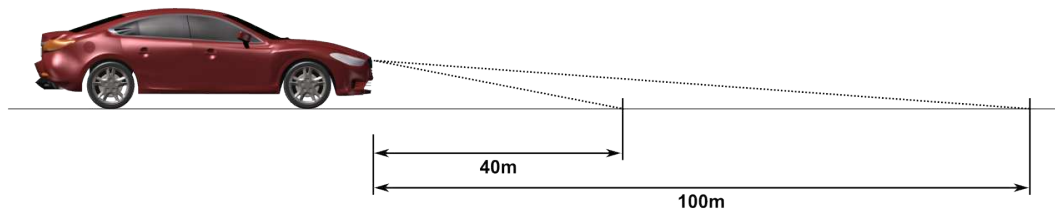

Figure 1: Headlamp criteria

These fundamental criteria don't describe the intensity values, any measuring procedure or how to prevent blinding the oncoming traffic. Therefore, different countries have developed their own standards and technical requirements.

The definition of a headlamp is determined by those standards. In Europe for instance the low beam is described by a "cut off" line which distributes the light beam in a sharp divided light and dark zone, while a low beam in America has to have minimal and maximal intensities in a number of predefined points.

## 2.2 Adjusting headlamps

The beam from a headlamp is normally directed towards the ground ahead of the vehicle for a low beam (approximately 40 m), and straight ahead for a high beam (approximately 100 m).

In order to better determine beam orientation, a perpendicular screen is placed in front of the vehicle at a somewhat shorter distance (a minimum of 10 m). On this screen, at the same height, and relative to the vehicle axis, the position of the headlamps are indicated.

The lamps can thus be adjusted and checked, taking in account the required inclination settings.

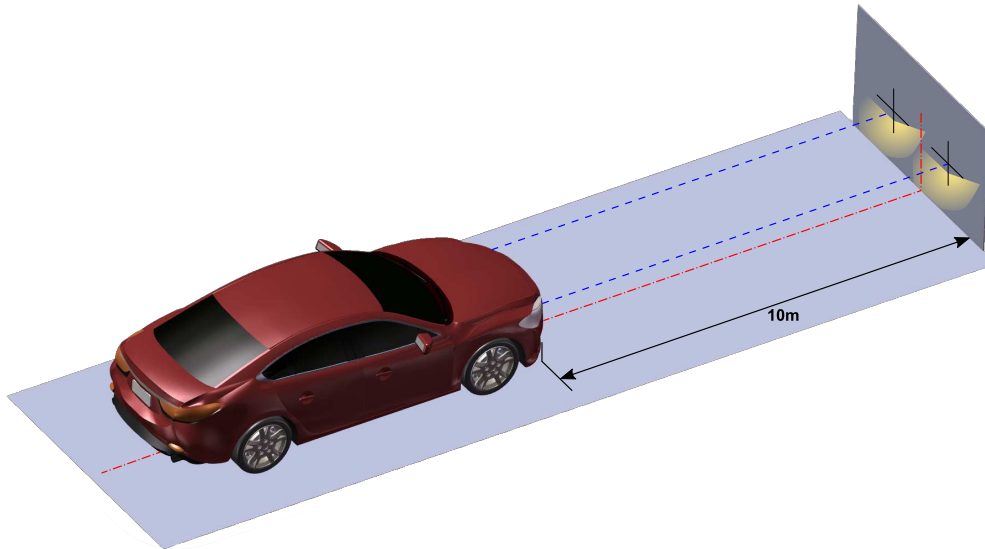

Figure 2: Basic principle of headlamp aiming on a 10m wall

If a white screen is placed at a distance of 10 m in front of the headlamp, the inclination angle (slope) of the headlamp under test can be determined and expressed in *cm/10m* or *%*. This kind of projection screen is also called a *10m wall*.

**L** is the distance between the headlamp and the projection screen and is equal to 10 m. The horizontal blue dotted line in the image below indicates the *mounting height* of the headlamp. This height should be marked on the *10m wall*. The sloped dotted line represents the beam projection of the *cut-off line* of the low beam. The inclination angle (slope) of the headlamp is indicated as  $\alpha$  and can be expressed in degrees.

**H** represents the distance between the *mounting height* of the headlamp and the beam projection of the *cutoff line*, measured on the *10m wall*. If  $L=10$  m and  $H=10$  cm, the headlamp inclination is equal to 10 cm/10m, or 1%.

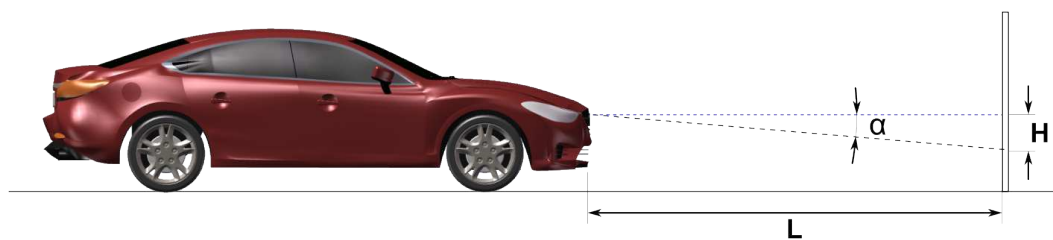

Figure 3: Beam slope

The following table provides the eventually needed conversion between the different units.

cm/10m	15	14	13	12	11	10	9	8	7	6	5	4	3	2	1	0
%	1.5	1.4	1.3	1.2	1.1	1	0.9	0.8	0.7	0.6	0.5	0.4	0.3	0.2	0.1	0
inch/25feet	4.5	4	3.5	3	2.5	2	1.5	1	0.5	0						
degrees	0.8			0.6			0.4			0.2						0

Figure 4: Unit conversion

This method has some disadvantages:

- It requires an indoor open area, over 10 meters long.
- The illumination level of that area has to be constant, mainly dimmed and not subject to the varying conditions of natural light.
- The axes must be meticulously specified for each and every different vehicle and for any new vehicle alignment process.
- The method is purely visual and highly dependent on the operator skills and interpretation.

## 2.3 Lens Principle

The use of a converging lens placed at the focal length reduces the distance to the screen dramatically and eliminates the need of a dark room.

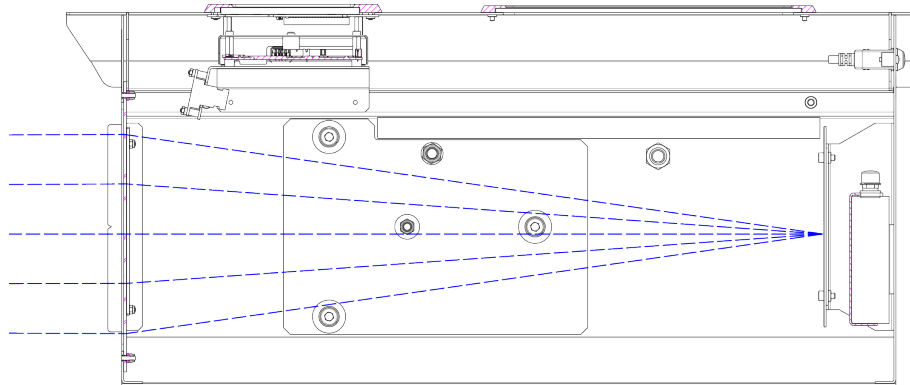

Figure 5: Parallel light rays entering the lens

All parallel rays from the same direction are concentrated in one point on the white projection screen inside the Luminoscope®.

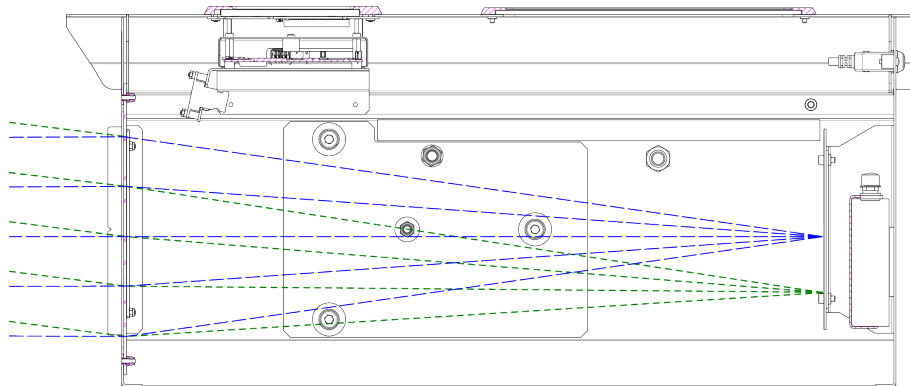

Figure 6: Parallel light rays from different angles entering the lens

Every point on the screen represents a collection of rays from the same direction.

## 2.4 Advantages of optical block with lens

The use of a collecting lens has advantages over the *10m wall* projection method.

- The distance to the screen is dramatically reduced: from 10 m to 0,5 m.
- The beam intensity is much higher, dimming or cancelling the ambient light is no longer necessary.
- The white projection screen is positioned at the focal distance of the lens. All parallel rays from the same direction are concentrated in one point. Consequently, the relative position of the system in relationship to the lamp becomes less important as the beam projection of the screen remains identical, independent of the place where the rays enter the lens.

It can be mathematically demonstrated that  $I = F^2 \times E$ , where  $F$  is the focal length of the lens.

Luminous intensity measurements in candela can thus easily be made. The result is the same, regardless of the place where the rays enter the lens, at the top or at the bottom.

Care should be taken, nevertheless, to capture a maximum of the light from the beam, since any light from the beam not entering the Luminoscope® will not be available for measurements and pattern building. To achieve it, the Luminoscope® is equipped with an electronic *Position Check* system which continuously monitors the position in front of the headlamp and guides the operator to determine the ideal position of the optical block lens in front of the headlamp.

## 2.5 Image processing

A CMOS camera points to the internal white projection screen and acquires the reflected image for further process.

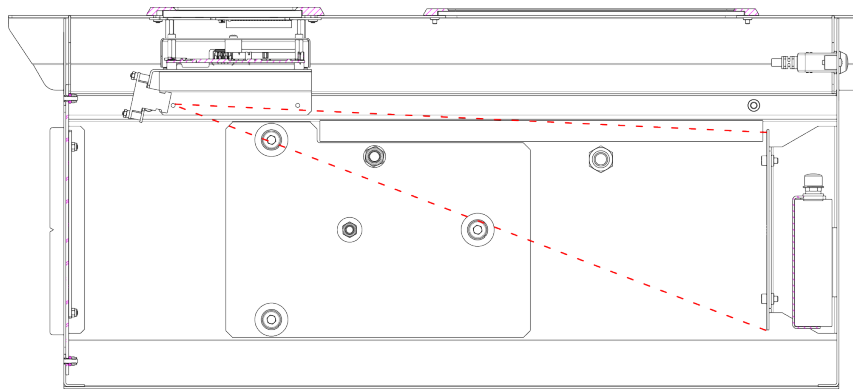

Figure 7: CMOS camera pointing at white projection screen

The horizontal and vertical lamp projection range is  $\pm 100$  cm/10m.

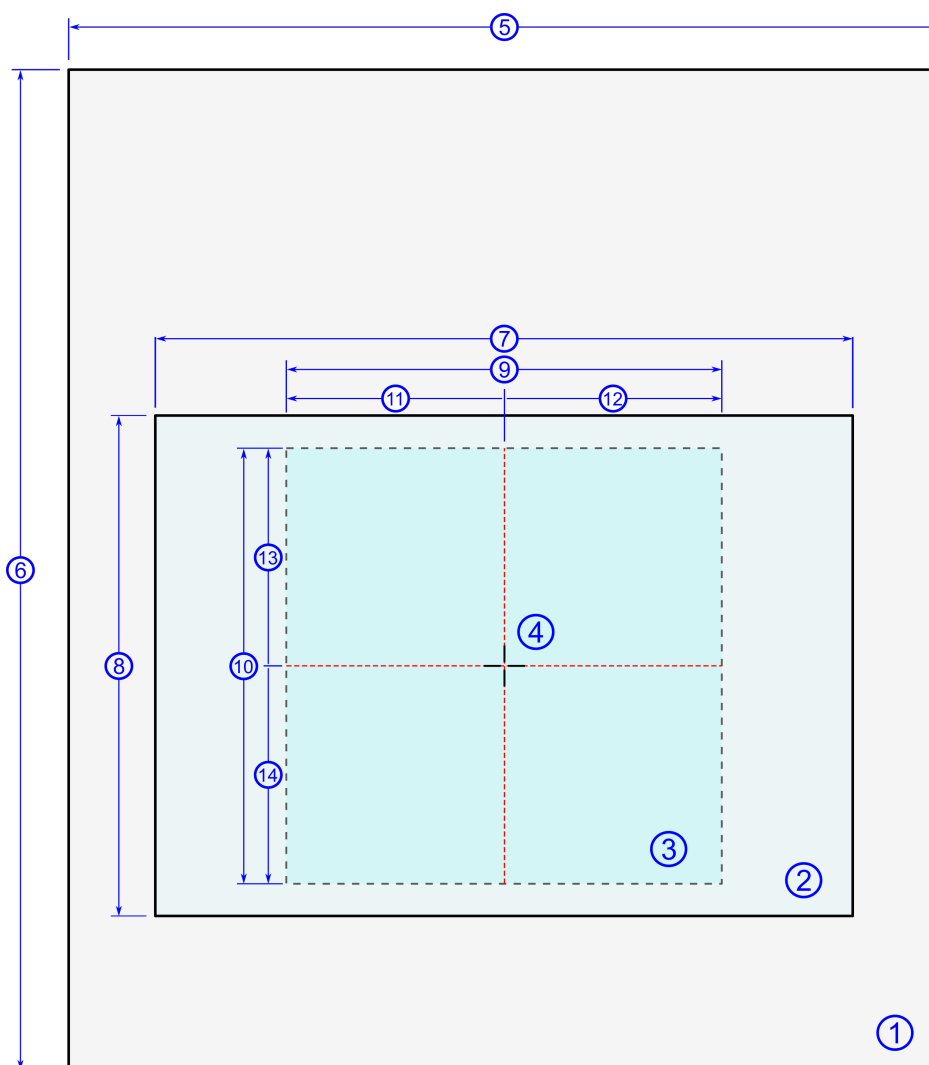

Figure 8: Projection screen with areas identification

#	Description	#	Description		
1	Projection screen area	2	Camera viewing area		
3	Lamp testing area	4	Absolute zero reference		
5	Horizontal projection screen range	6	Vertical projection screen range		
7	Horizontal viewing range	270 cm/10m	8	Vertical viewing range	220 cm/10m
9	Horizontal lamp testing range	200 cm/10m	10	Vertical lamp testing range	200 cm/10m
11	Leftwards testing range	-100 cm/10m	12	Rightwards testing range	+100 cm/10m
13	Upwards testing range	+100 cm/10m	14	Downwards testing range	-100 cm/10m

The shutter setting of the camera is automatically controlled to provide an image with the highest possible dynamic range and without any clipping. This allows absolute intensity measurements in kCd.

Camera data is analyzed by powerful algorithms to determine the position of the beam and to obtain other relevant data.

## 2.6 Alignment with the vehicle

In order to obtain a reliable measurement of the headlamp, it is necessary to achieve a good alignment of the Luminoscope® with the slope of the vehicle standing area and the longitudinal axis of the vehicle.

### In the horizontal plane

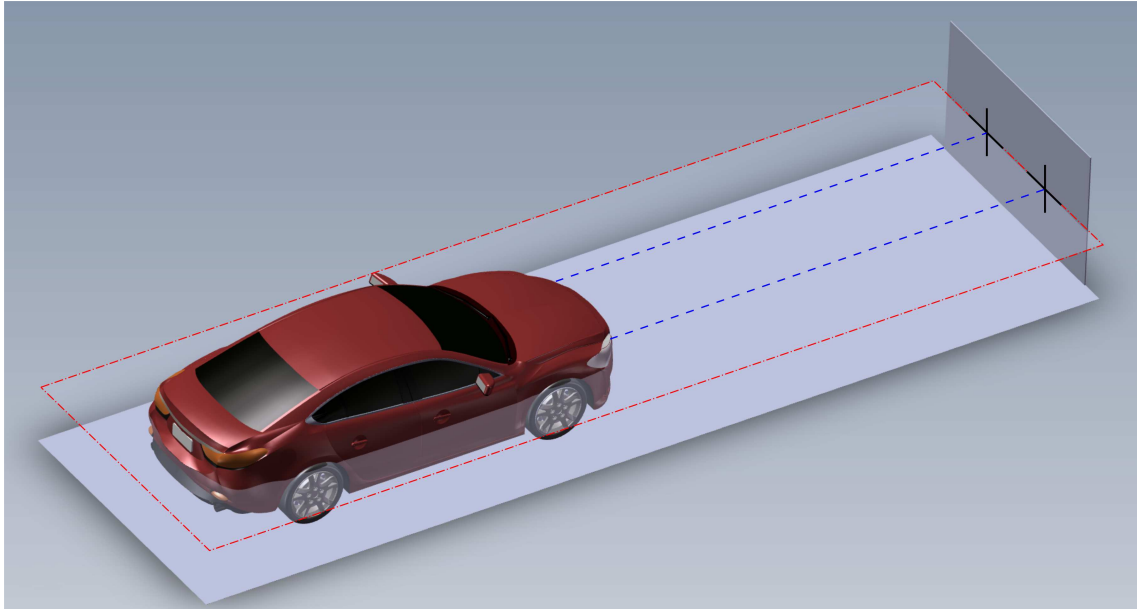

Figure 9: Horizontal plane alignment

The easiest way to achieve a good horizontal alignment with the vehicle is to place the vehicle on a horizontal floor and set the optical block also horizontal with the aid of the spirit level. In practice not so many floors are perfectly horizontal. There are two practical methods to achieve it:

- Measure the floor slope (check corresponding manual) and tilt the optical block in the same direction with the same slope.
- Measure the floor slope and add or subtract that value (depending on the direction of the floor slope) to the computed value of the beam position by the optical block.

## In the vertical plane

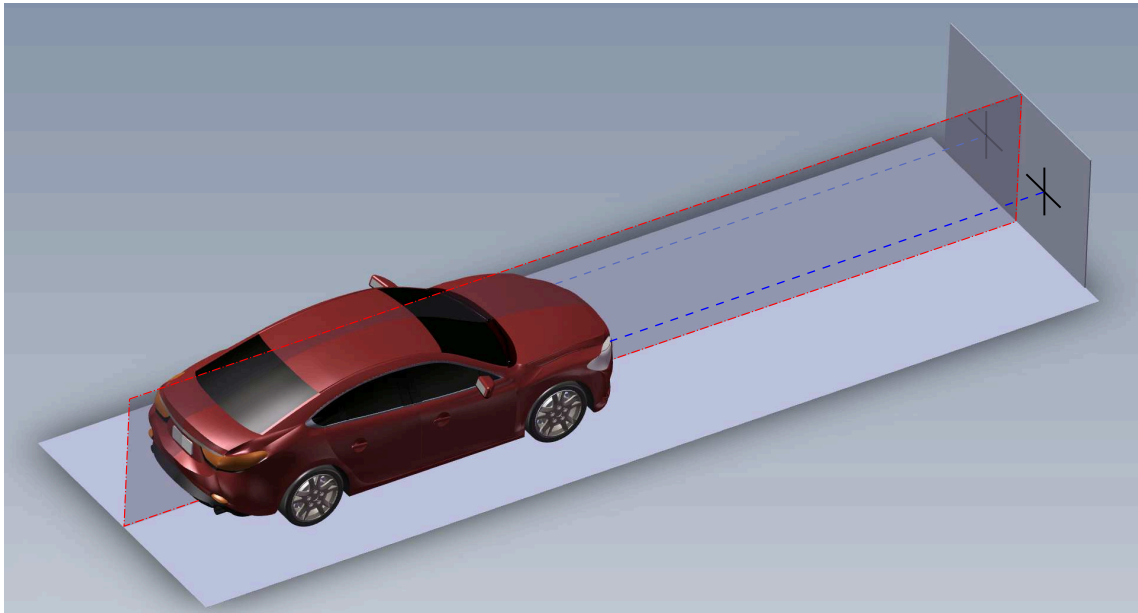

Figure 10: Vertical plane alignment

The precision of the measurement of the L/R position of the beam depends mainly on the vertical alignment of the vehicle towards the optical block. As an example, a simple misalignment of 5 mm on a wheelbase of 2 m will give an error of  $5 \times 5 \text{ mm} = 2.5 \text{ cm}/10\text{m}$  in the L/R measurement of the beam.

The vertical plane is also called the *longitudinal direction* of the vehicle.

Several different methods are applicable to ensure the correct alignment of the vehicle with the optical block axis. Some vehicle factories are using a painted guiding line on the floor, providing their units with a *bolt aligner* device such as below described.

The trolley base of the Luminoscope® system is equipped with an alignment device with two bolts for adjusting and locking the stand rotation. This is used for correctly aligning the optical axis of the Luminoscope® with the longitudinal direction of the vehicle standing area. The rotational position of the stand should be set once during the calibration procedure of the Luminoscope®. It should be locked at the position where the optical axis of the Luminoscope® corresponds with the longitudinal direction of the vehicle standing area.

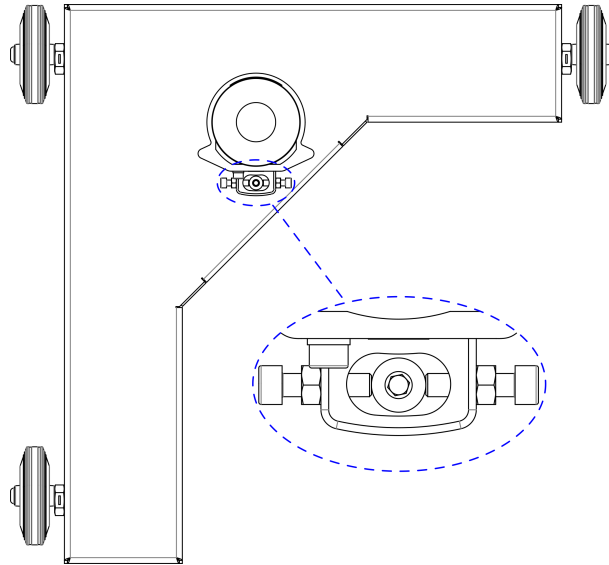

Figure 11: Alignment device for adjusting and locking stand rotation

The longitudinal direction of the vehicle should be aligned parallel with the longitudinal direction of the vehicle standing area. To achieve a good alignment of each vehicle, a drive-in guiding system can force the vehicles to the correct longitudinal position in front of the Luminoscope®.

**WIP: Next paragraph needs to be reviewed.**

This is an example of a drive-in guiding system based on painted lines on the floor and the driving skills of the operator.

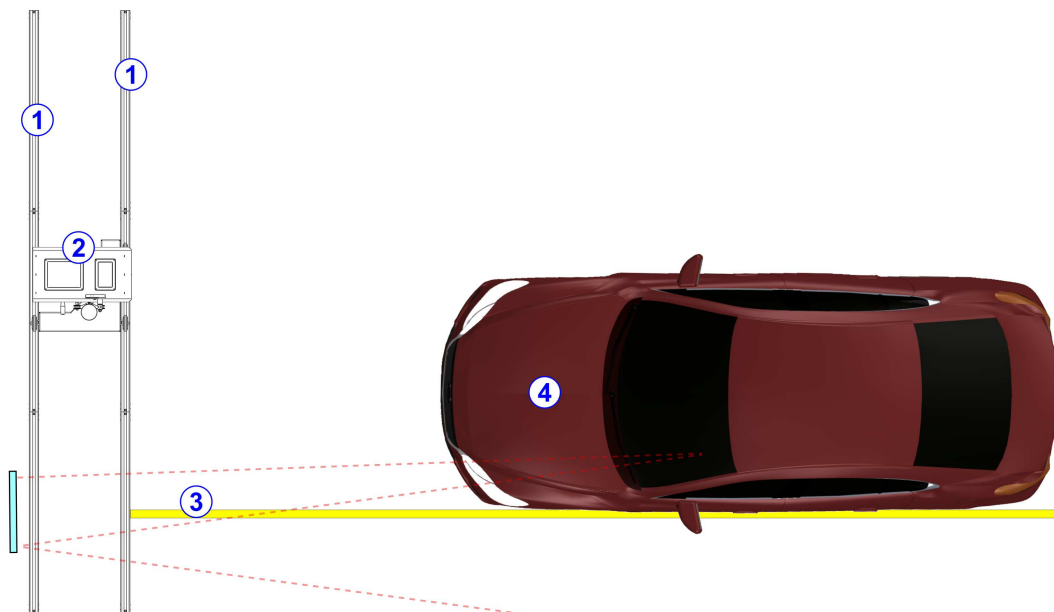

Figure 12: Example of a guiding line on the ground

Standard alignment methods are described below.

In order to help the operator to correctly align the Luminoscope® with the longitudinal axis of the vehicle, the system is equipped with an alignment laser. The laser line should be calibrated perpendicular with the optical axis of the headlamp tester.

The operator rotates the stand, looking for the intersection point of the reference line of the laser projection with two symmetrical points on the vehicle which are also considered as perpendicular with the longitudinal axis of the vehicle.

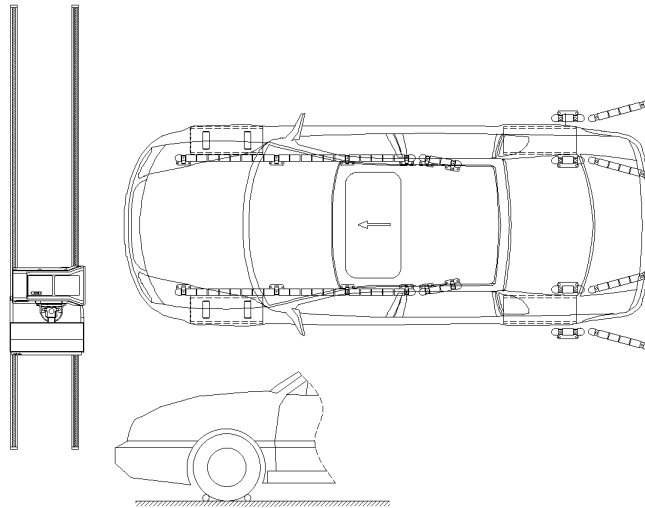

Figure 13: Drive-in guiding system on vehicle installed area



**Note:** The set-up may have a different appearance depending on customer specific implementation.

Several systems are applicable to ensure the correct alignment of the vehicle in the vertical plane, such as painted guiding lines on floor, a wheel aligner system, a centralizer system, a vehicle alignment measurement system (VAM), etc.

This procedure ensures the longitudinal alignment between the Luminoscope® and the vehicle longitudinal axis.

## 2.7 Positioning in front of the headlamp

It is of great importance that the lens of the Luminoscope® is correctly positioned in front of the headlamp to ensure that as many light rays as possible enter the lens.

This guarantees that the beam image is displayed realistically on the white projection screen inside the Luminoscope® to be able to perform a correct headlamp measurement.

With this purpose, the Luminoscope® system is provided with the electronic *Position Check* system that uses four solar cells around the lens 1.

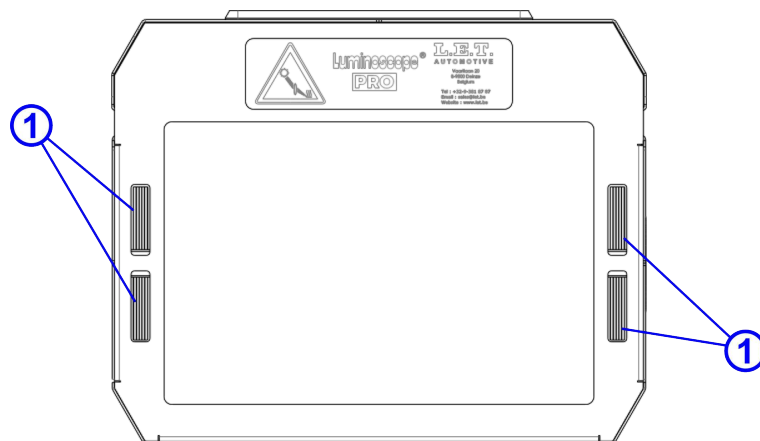

Figure 14: Position Check cells around the lens



---

# 3 Headlamps

---

This is a review of the illumination patterns that different headlamps produce.

## 3.1 ECE or European low beam



**Note:** Both terms *low beam* and *dipped beam* refer to the same type of headlamp and are used interchangeably.

The purpose of the low beam is to illuminate the road ahead of the vehicle and traffic signs up to a distance of approximately 40 m without blinding oncoming traffic. The asymmetrical low beam must be adjusted on a predefined inclination value. In Europe e.g. it's an inclination between -1% (or -10 cm/10m) and -1.5% (or -15 cm/10m). The reference point of the beam is the intersection of the horizontal part with the sloped part and is referred to as *V-point*. It is also called *kink point* and *elbow point*.

There exist two types of ECE low beams, depending on which side of the road the vehicle is driving:

### LHD (Left Hand Drive)

---

The steering wheel is positioned on the left side of the vehicle and the driver uses the right side of the road. Some examples of countries on which this driving type is implemented include (but are not limited to) Belgium, France and Germany, among many others.

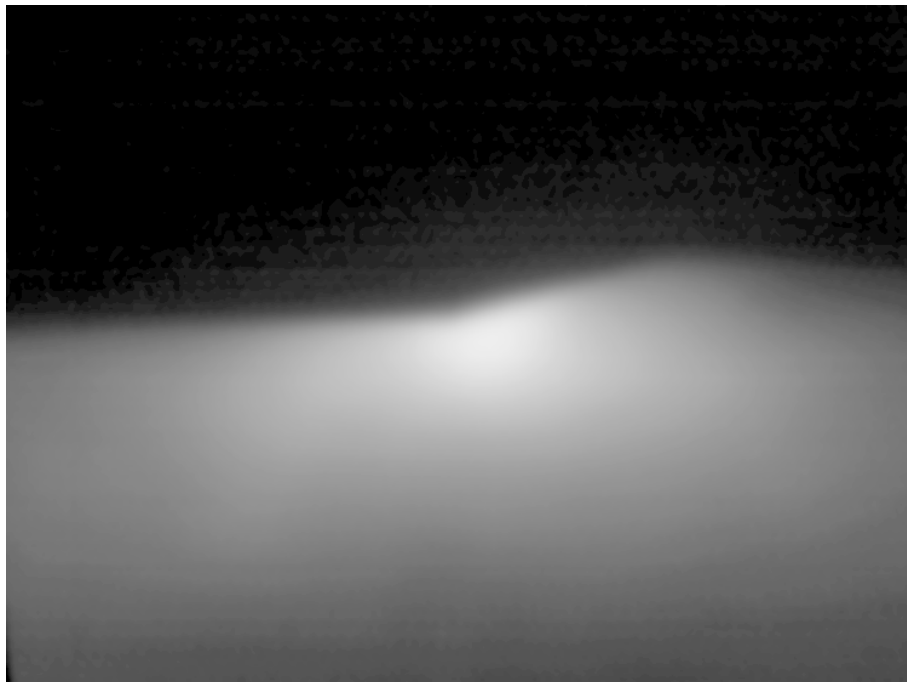

Figure 15: Low beam LHD

### RHD (Right Hand Drive)

---

The steering wheel is positioned on the right side of the vehicle and the driver uses the left side of the road. Some examples of countries on which this driving type is implemented include Great

Britain, Ireland, Japan, Thailand, Malaysia, Indonesia, New Zealand, Australia, India, South Africa, among many others.

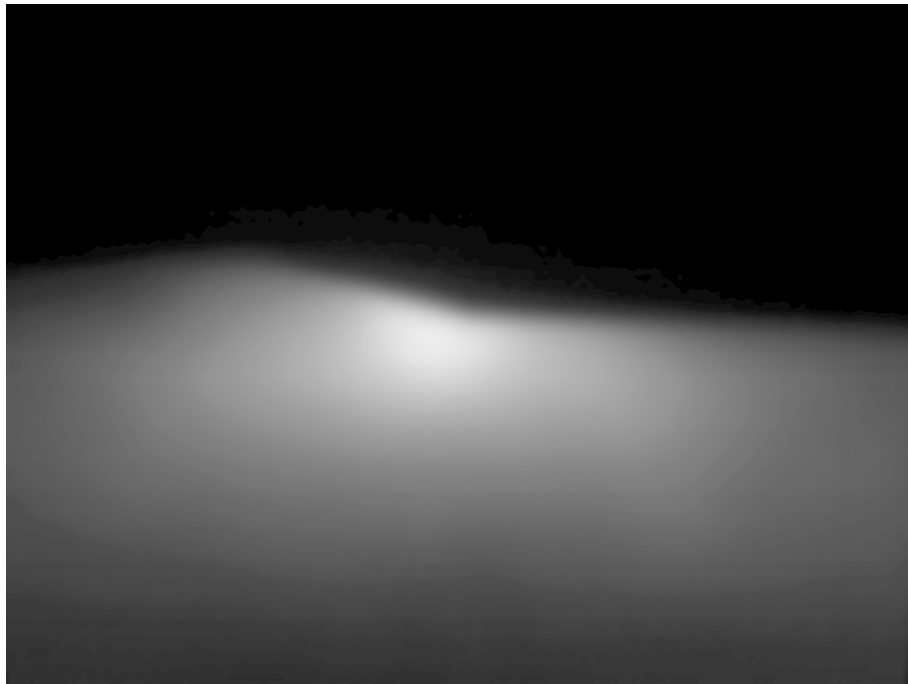

Figure 16: Low beam RHD

The world map below shows the implemented driving types for each country.

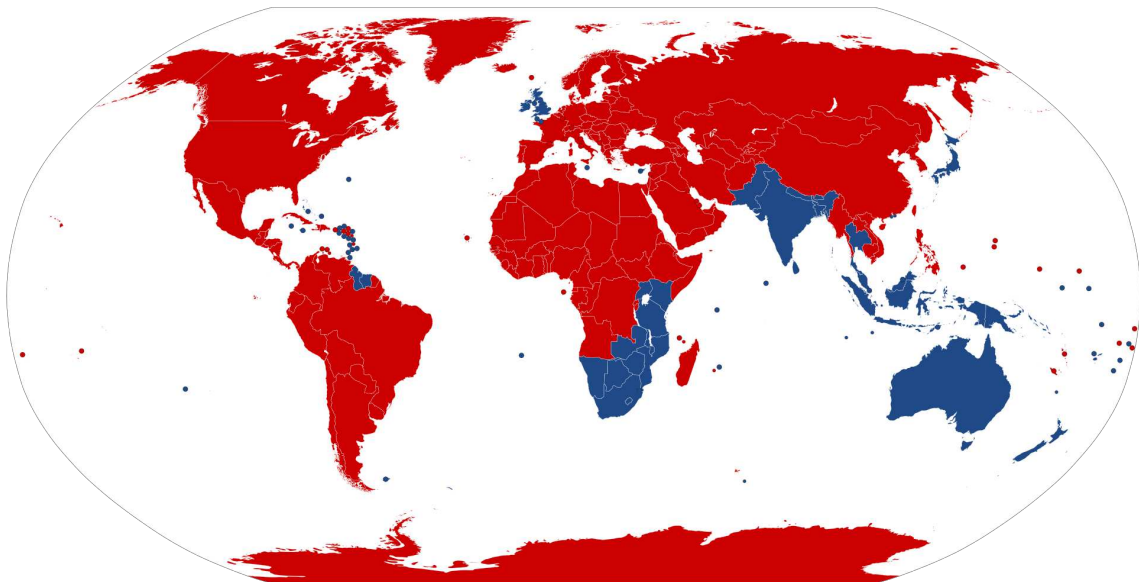

Figure 17: Implementation of LHD and RHD driving types across the world

## 3.2 High beam



**Note:** The terms *high beam* and *main beam* refer to the same type of headlamp and are used interchangeably.

The purpose of the high beam is to illuminate the road ahead of the vehicle at a further distance of approximately 100 m. The form of the beam is rather oval. The reference point is the point with the highest intensity (hotspot).

There are two different ways of construction:

- The high beam is integrated in the same housing of the low beam. Consequently, it is not possible to separately adjust high and low beams. In most countries, only the low beam is adjusted because this is the driving beam. Due to the construction of the headlamp, the high beam will be at fixed inclination value that is 1% or 10 cm/10m higher than the low beam value.
- The high beam is a standalone headlamp and both beams can be separately adjusted with their own adjusting screws. Adjustment of the high beam is done at a value of 1% or 10 cm/10m higher than the low beam value.

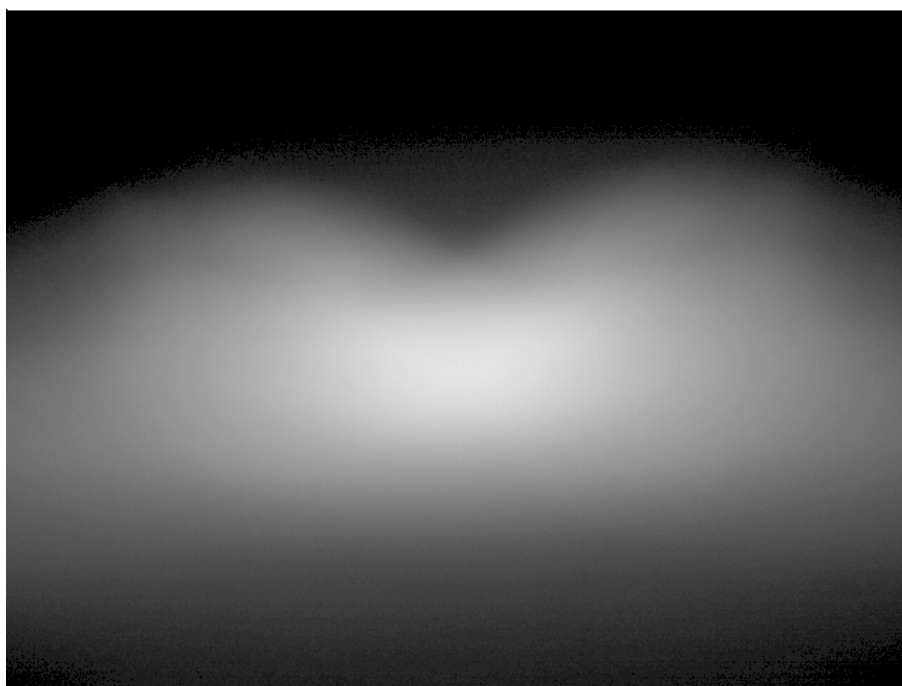

Figure 18: High beam

### 3.3 Fog beam

Fog beams are mounted at the front bottom of the vehicle and illuminate the road as far as possible under fog, heavy rain or snow conditions.

The form of the beam is a broad band of light, where the reference is the flat horizontal top line (*cut-off line*) which is normally adjusted at 1% or 10 cm/10m below the low beam value. A fog beam only has one adjusting screw controlling the inclination.

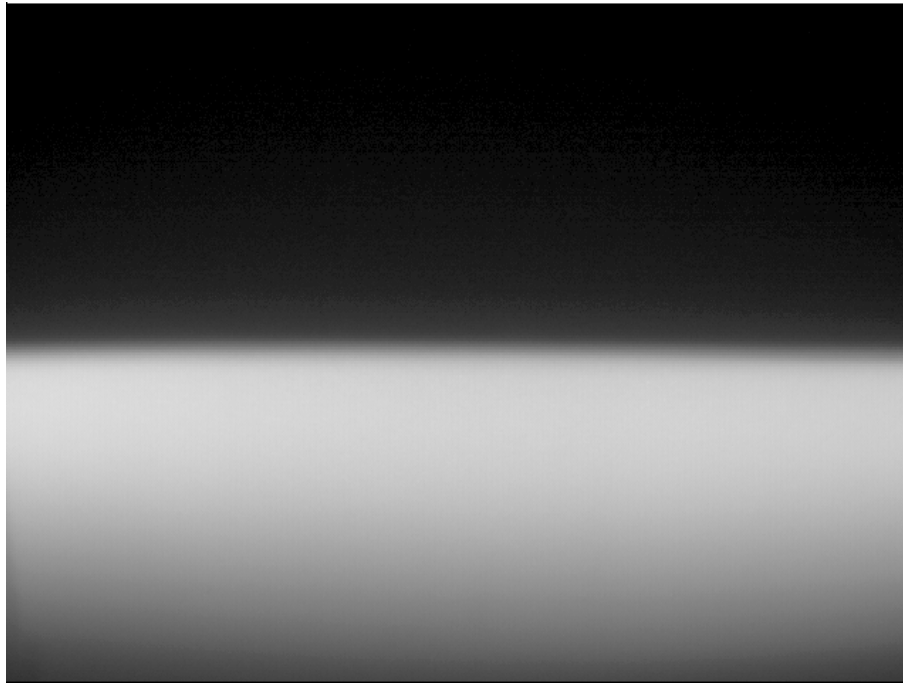

Figure 19: Fog beam

### 3.4 SAE or American low beam



**Note:** Both terms *low beam* and *dipped beam* refer to the same type of headlamp and are used interchangeably.

SAE (Society of Automotive Engineers)/ American low beams have an LHD shaped *cut-off line* with a small step and a zone of high intensity (*hotspot*) on the right side of the small step.

American low beams must be aimed – according to the marking on the glass – referring to the left or right side of the *cut-off line*.

There are two types of American low beams, requiring different adjustment methods:

**VOL - Visually Optical Left**

The left part of the *cut-off line* should be aimed at an inclination of -0,7%.

**VOR - Visually Optical Right**

The right part of the *cut-off line* should be aimed at an inclination of 0%.

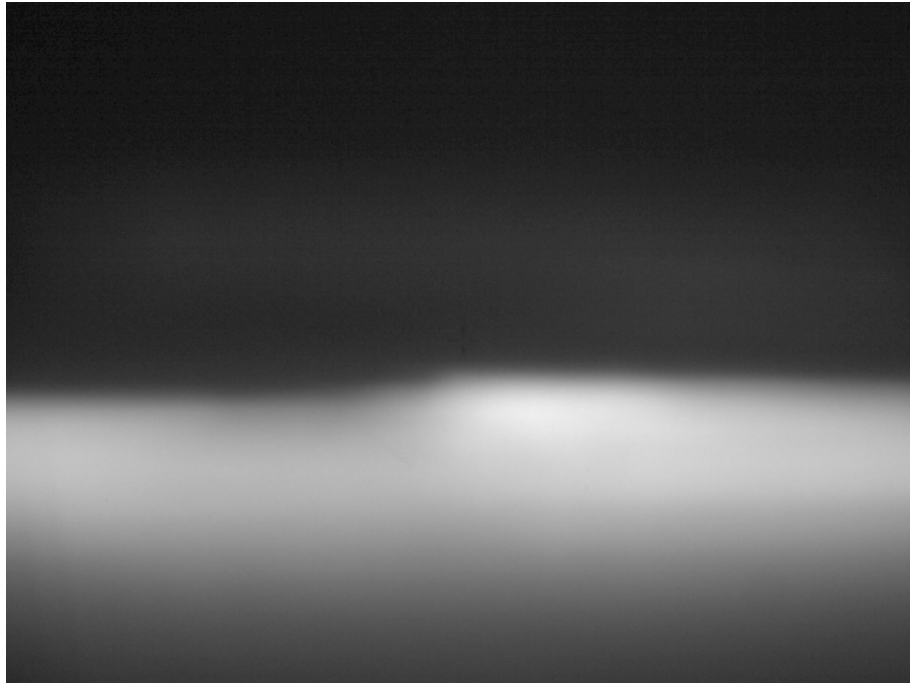

Figure 20: SAE low beam VOL or VOR

### 3.5 Japanese low beam



**Note:** Both terms *low beam* and *dipped beam* refer to the same type of headlamp and are used interchangeably.

The Japanese low beam has some similarities with a mirrored image of the SAE low beam, because the Japanese driver uses the left side of the road (RHD). However, there are subtle details regarding the different heights of the zones at both sides of the step which make them different.

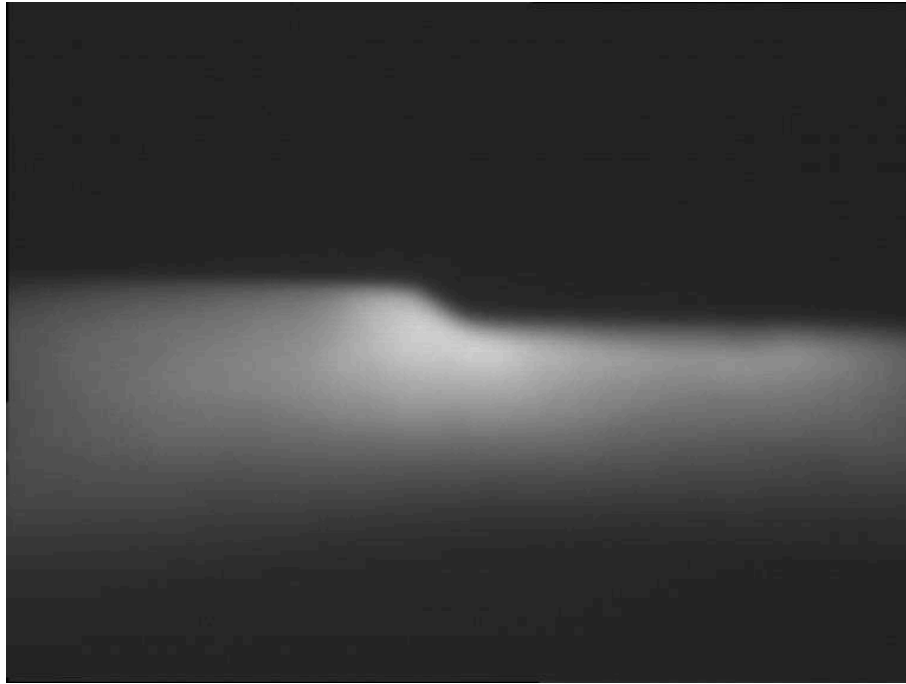

Figure 21: Japanese low beam

## 3.6 Dynamic headlamps and intelligent lighting systems

In order to improve road safety, sophisticated technologies are introduced to make lighting systems more intelligent.

These new technologies include *adaptive front lighting*, *variable intelligent lighting*, *dynamic bending lights*, *dynamic light spots*, *glare free high beam*, etc.

Most of these headlamps are controlled by electronic systems of the car, such as intelligent cameras, radars, steering angle detection, etc. These kinds of headlamps need special adjustment sequences and usually require a calibration set-up of the vehicle (through vehicle specific diagnosis link). The calibration values should be stored afterwards in the electronic control unit (*ECU*) of the vehicle.

### 3.6.1 Glare free high beam with beam motorisation



**Note:** The terms *high beam* and *main beam* refer to the same type of headlamp and are used interchangeably.

An intelligent camera, fitted behind the windscreen, detects both vehicles in front of the car and oncoming vehicles. The high beam zone that might cause glare is darkened by adjusting the light image (by means of a servomotor). The beam images underneath can be moved horizontally avoiding glare at one specific zone on the road.

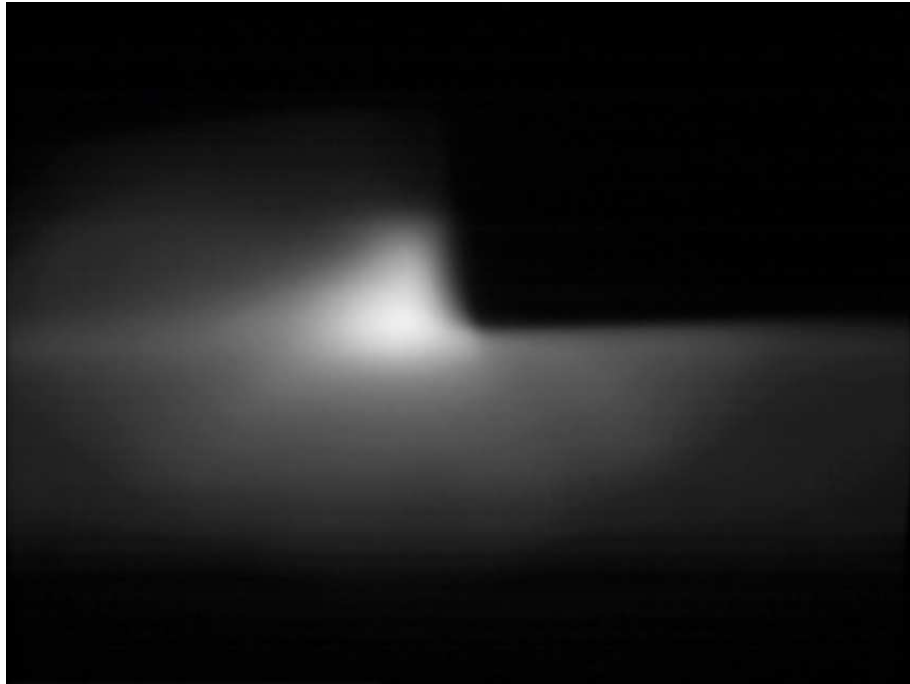

Figure 22: Left glare free high beam

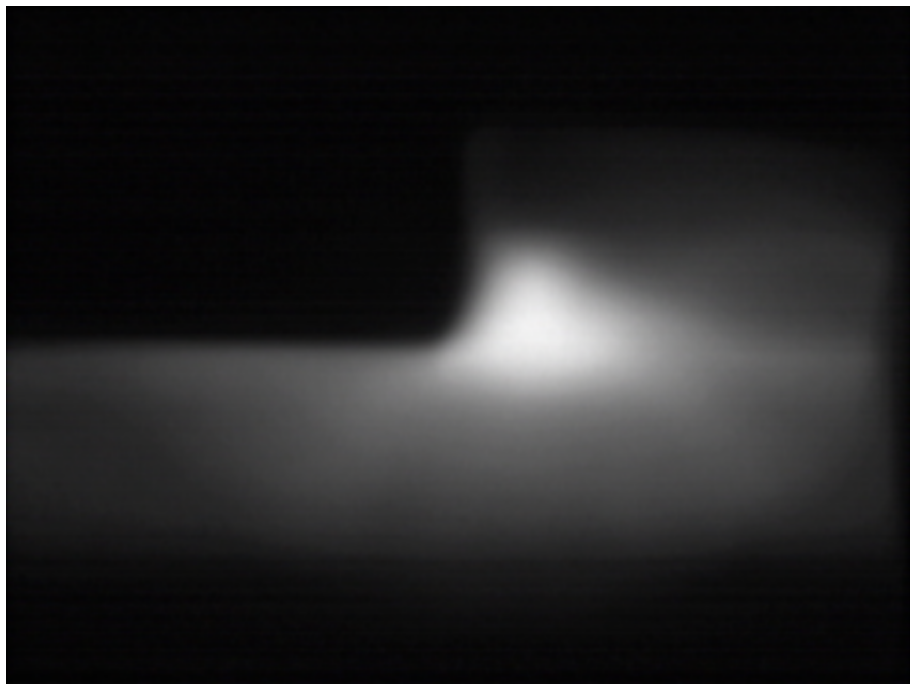

Figure 23: Right glare free high beam

An example of this headlamp principle is the *MDF (Maskiertes Dauerfernlicht)* high beam.

### 3.6.2 Glare free high beam with multiple static LED sources

An intelligent camera, fitted behind the windscreen, detects both vehicles in front of the vehicle and oncoming vehicles. The high beam zones that might cause glare are darkened by dimming or switching off one or more *LED* sources. So the overall high beam image is electronically controlled in order to avoid glare at multiple zones on the road.



Figure 24: Matrix high beam simulation scene

Calibrating a *Matrix* high beam with a headlight tester requires in most cases a calibration set-up of the vehicle (through vehicle specific diagnostics link) to selectively switch on only one of the *LED* sources as a reference.

The horizontal position of the reference spot should be mechanically adjusted or in other cases its position should be measured. The position is stored afterwards in the electronic control unit (*ECU*) of the vehicle.



Figure 25: Reference spot of matrix high beam

An example of this headlamp principle is the *Matrix* high beam.

### 3.6.3 Dynamic low beam



**Note:** Both terms *low beam* and *dipped beam* refer to the same type of headlamp and are used interchangeably.

With a dynamic low beam, the horizontal position of the beam can be controlled by the steering angle, to achieve the most optimal light distribution on the road in all conditions (e.g. when the vehicle takes a turn). There are different technologies available for this purpose.

By means of a servo motor, the horizontal *cut-off line* position is automatically adapted during driving. In addition, there are also systems available with multiple *LED* sources as in the image underneath. It shows an LHD low beam *cut-off line* with a step of 90°. The upper part of the *cut-off line* (horizontal bar with the highest intensity on the right side of the image) can be made wider or smaller, depending on the steering angle of the vehicle. This is done by controlling the *LED* sources in order to have the most optimal road illumination for all steering angles when driving in low beam mode.

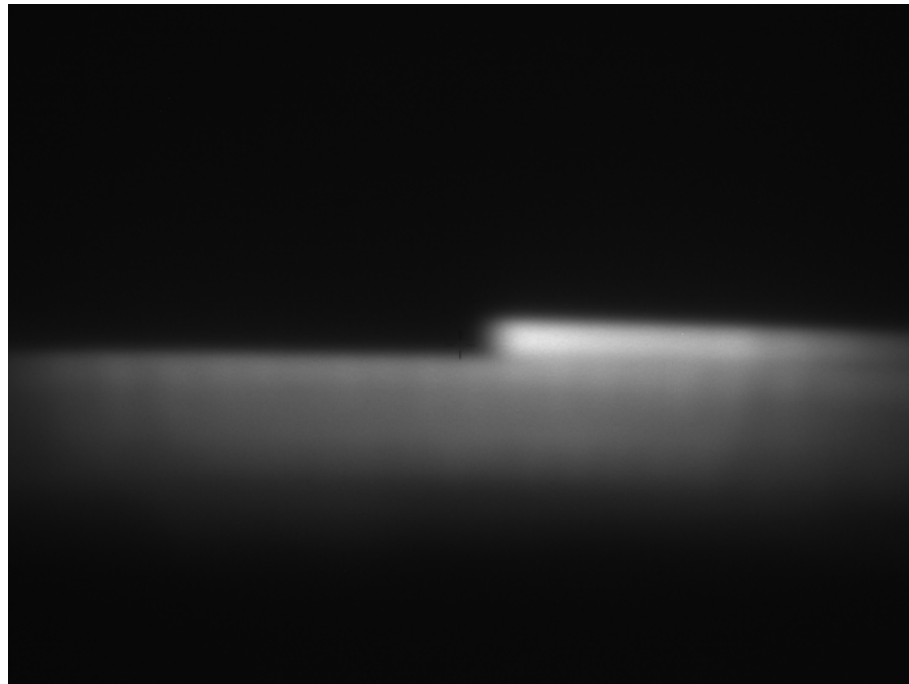

Figure 26: Dynamic low beam projection



---

# 4 Prerequisites for checking or adjusting

---

In order to achieve an accurate and stable headlamp measurement or adjustment, a number of prerequisites must be taken care of.

## 4.1 Prerequisites for the vehicle

- The front wheels must be in the straight-line travel position.
- The tires should be inflated to manufacturer specified pressures.
- The vehicle should be empty, with the handbrake released.
- The springs and the shock-absorbers should be in their equilibrium positions. For vehicles with hydro-pneumatic suspension, the motor should be running.
- When the vehicle is equipped with a manual control to adjust the low beam, verify that it is in its rest position.

## 4.2 Prerequisites for the headlamps

- Check that the headlamps are rigidly connected to the vehicle.
- Check whether the two lamp glasses are identical, whether they are in their correct angular position and that they are not cracked.
- Check that the lamp glasses are clean and whether the reflectors are in a satisfactory state.
- Check that the headlamp units neither contain any water, nor are misted up.

## 4.3 Positioning the system

- Locate the vehicle approximately 20-60 cm from the lens of the headlamp tester.



# 5 Technical characteristics

## 5.1 SLA 40 models

Depending on the provided guiding system, there are different Luminoscope® models available.

Types	Standard column + standard trolley	Long column + standard trolley	Standard column + wide trolley	Long column + wide trolley	Description
Double rail	DR	DR L	DR D	DR D L	The two V-shaped front wheels of the trolley base are guided on a hexagonal rail. The simple flat wheel runs on the square rail. The uniform levelling of the rails can be easily adjusted to obtain a perfect horizontal movement over the whole length of the rails.
Single rail	SR	SR L	SR D	SR D L	The two rubber front wheels of the trolley are guided on a simple V-shaped steel rail, attached to the floor. The rubber rear wheel runs on the floor. There is no adjustment mechanism provided to adjust the uniform levelling of the rail.
No rail	NR	NR L	NR D	NR D L	The three rubber wheels of the trolley base run on the floor. The Luminoscope® can be used on different locations which have identical floor slope for the vehicle standing area.



**Note:**

- **L** models are provided with a longer column, extending their vertical range in 200 mm. This extra length makes the unit suitable for vehicles with higher headlamps mounting, such as some trucks, buses and other special purpose vehicles.
- **D** trolley units are provided with a versatile base with a different shape than the standard trolley base. The **D** trolley base can be equipped with different wheel types and different tracking distances.

**Luminoscope® SLA 40 DR**

---

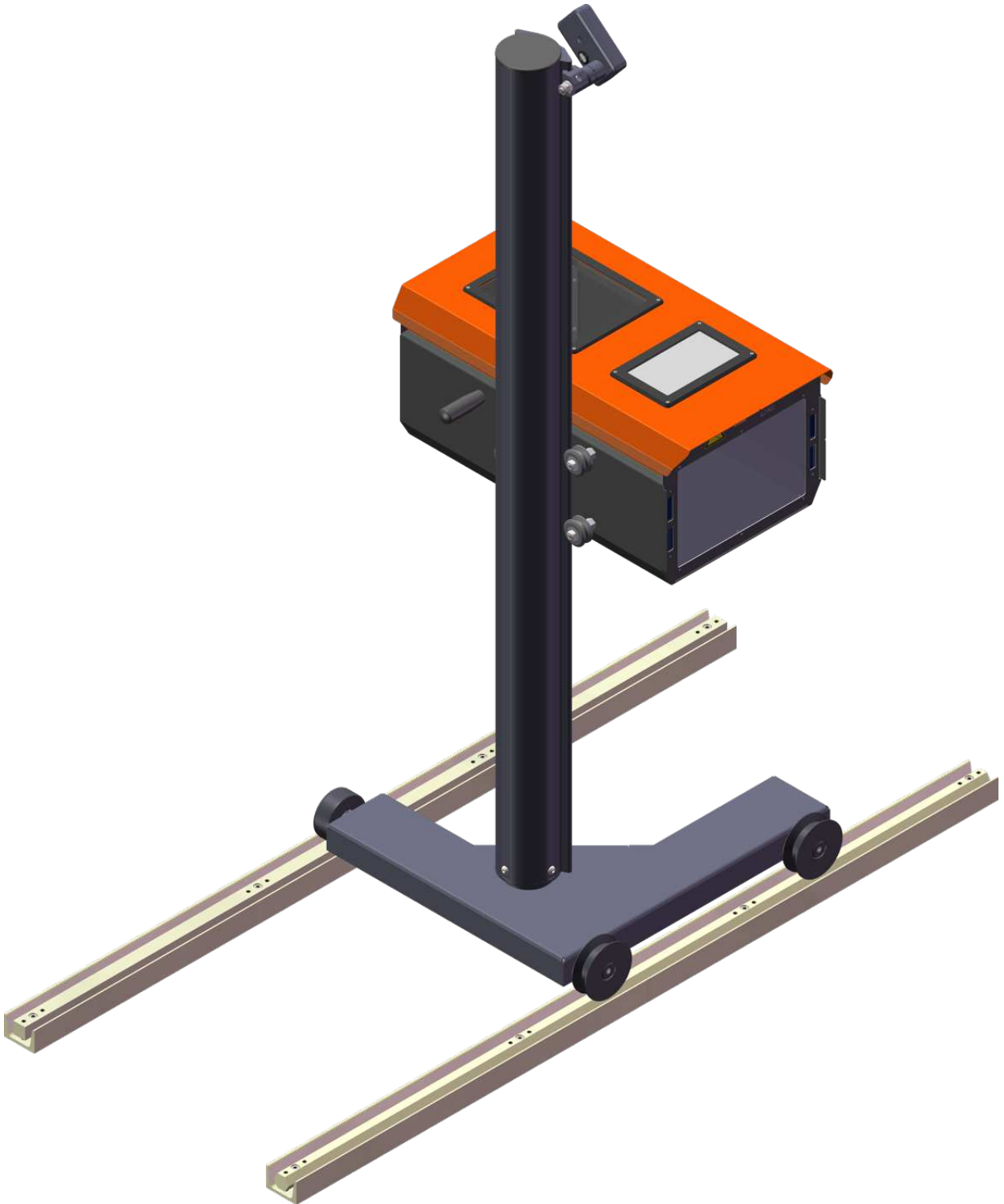

*Figure 27: General view of Double Rail model (SLA 40 DR)*

**Luminoscope® SLA 40 SR**

*Figure 28: General view of Single Rail model (SLA 40 SR)*

## Luminoscope® SLA 40 NR

---



*Figure 29: General view of No Rail model (SLA 40 NR)*

### 5.2 Guiding systems

The two front wheels of the trolley base of the Luminoscope® SLA 40 can be guided on one non-adjustable rail profile that is fixed to the floor. Other systems are guided on two robust adjustable rails which are fixed to the floor or recessed in the floor.

Guiding the Luminoscope® SLA 40 on rails ensures an easier alignment of the Luminoscope® with the vehicle. In case the rails are adjustable, the Luminoscope® remains horizontally along the entire range of the rails.

Luminoscope® SLA 40 systems without guiding rails are also available. In this case, the rubber wheels of the trolley base are just running on the floor. The equipment can be used on different locations which have the same floor slope for the vehicle standing area.

On systems with non-adjustable rails or without any rails, the inclination of the optical block will subtly vary without any doubt while displacing the system. This has a direct consequence on the measurement results of the Luminoscope®.

There are three different guiding systems available, depending on the use or type of rail:

- DR – Double Rail
- SR – Single Rail
- NR – No Rail

### 5.2.1 SLA 40 DR: double rail

The two V-shaped front wheels 1 of the trolley base are guided on a hexagonal rail 2. The simple flat rear wheel 3 runs on the square rail 4. The uniform levelling of the rails can be easily adjusted to obtain a perfect horizontal movement of the Luminoscope® over the entire length of the rails.

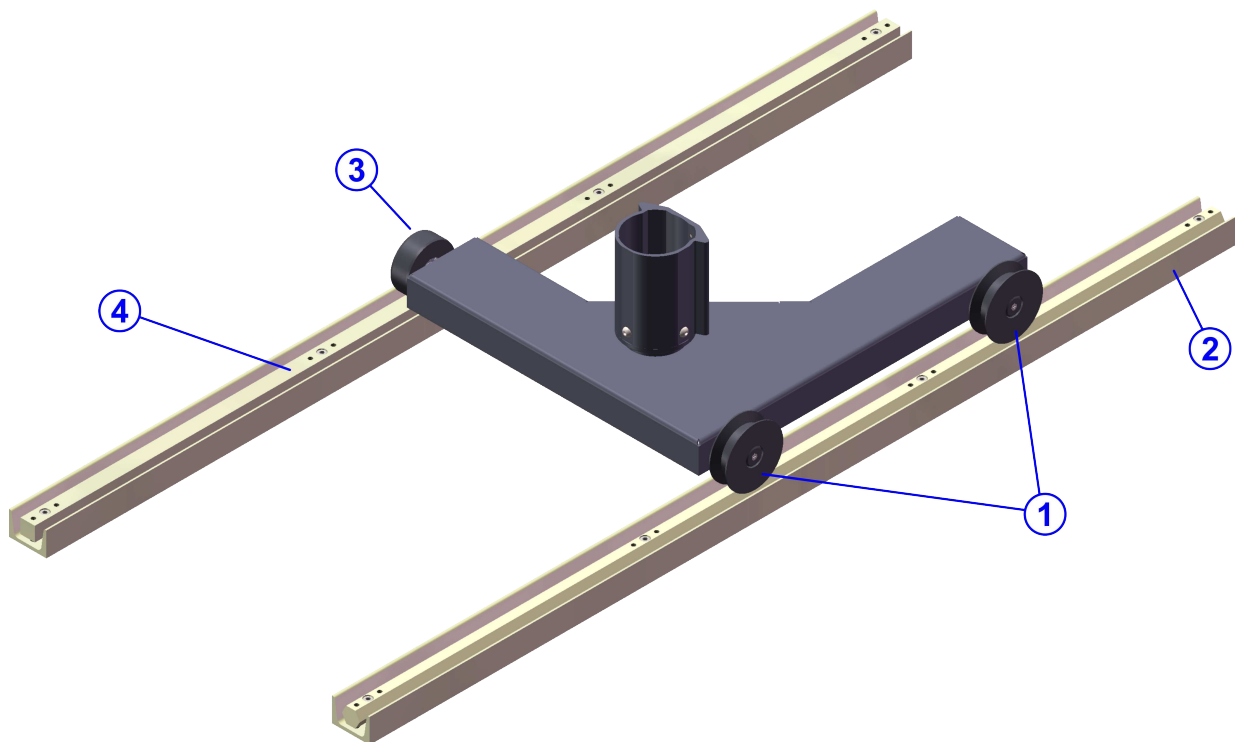

Figure 30: Double rail (DR)

### 5.2.2 SLA 40 SR: single rail

The two front rubber wheels 1 of the trolley base are guided on a simple V-shaped steel rail 2, attached to the floor. The rear rubber wheel 3 runs on the floor.

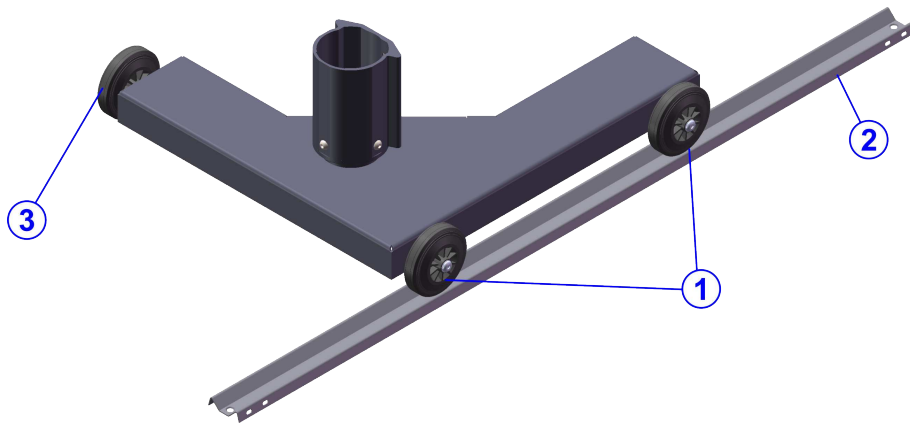

Figure 31: Single rail (SR)

There is no adjusting mechanism provided to adjust the uniform levelling of the rail.

### 5.2.3 SLA 40 NR: no rail

The three rubber wheels of the trolley base run on the floor.

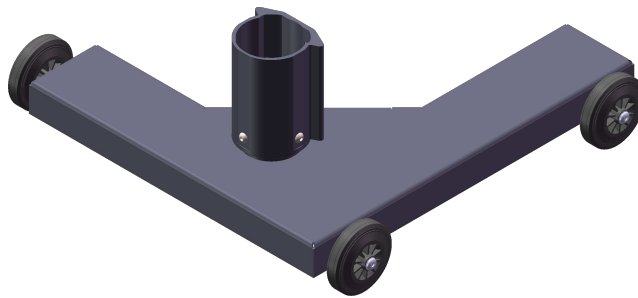

Figure 32: No rail (NR)

The system can be used on different locations which have an identical floor slope for the vehicle standing area.

## 5.3 Layout

The following sections include detailed graphics and callouts of the Luminoscope® which lead to an easier identification of the different parts and models.



**Note:** Depending on the ordered options or local regulations, the supplied unit may look slightly different from the following drawings.

## 5.3.1 Front view

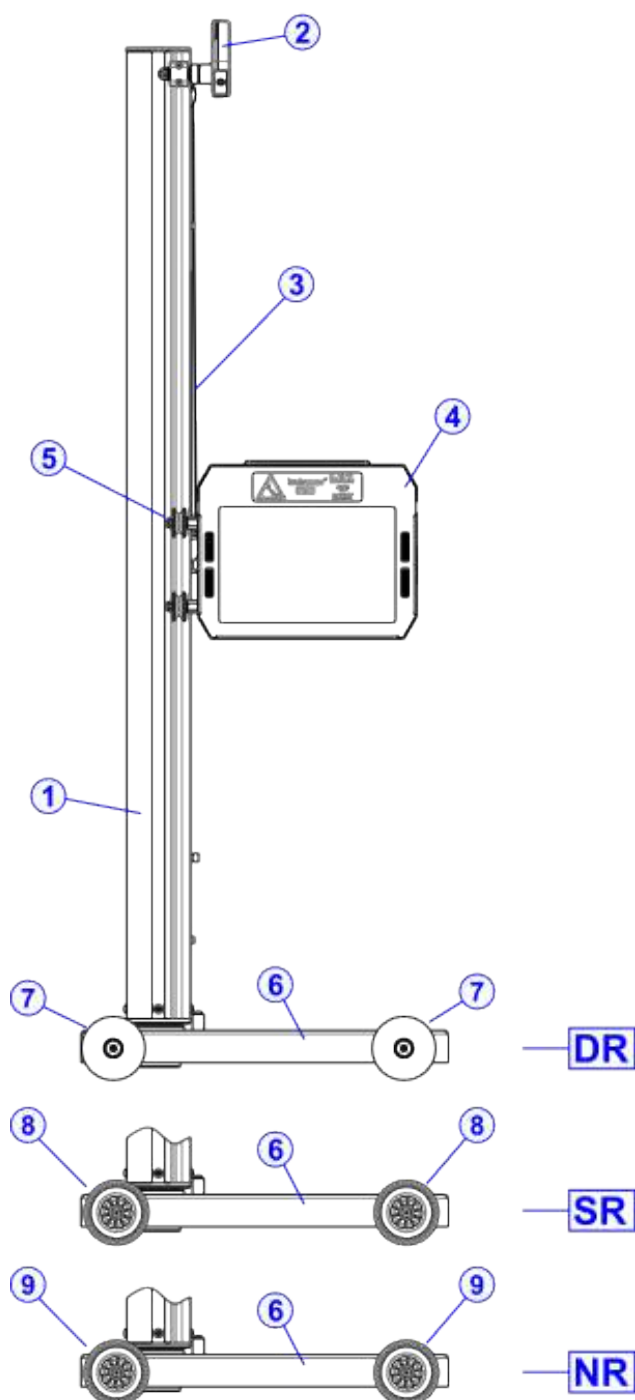

Figure 33: Front view of the Luminoscope®

#	Part	Description
1	Stand	The optical block is attached to the vertical fins of the stand.
2	Green alignment laser	Used to align the optical axis of the optical block with the longitudinal axis of the vehicle.
3	Counterweight cable	Connects the optical block with the counterweight inside the stand.

#	Part	Description
4	Optical block	The optical block includes a lens, a white projection screen, a digital camera, a control panel and a connector plate. Captures, processes and analyzes the headlight beam projection.
5	Vertical V-wheels	V-wheels sliding vertically on the fins of the column.
6	Trolley base	The trolley base on wheels ensures the stability and the perpendicularity of the system.
7	V-wheel with eccentric axle	Front wheel guides the system on the hexagonal rail. Provided with an eccentrical axis which allows the vertical adjustment of the stand.
8	Rubber wheel with eccentric axle	The rubber wheel runs on a non-adjustable rail profile. Provided with an eccentrical axis which allows the vertical adjustment of the stand.
9	Rubber wheel with eccentric axle	The rubber wheel runs on the floor. Provided with an eccentrical axis which allows the vertical adjustment of the stand.

### 5.3.2 Top view

#### SLA 40 DR

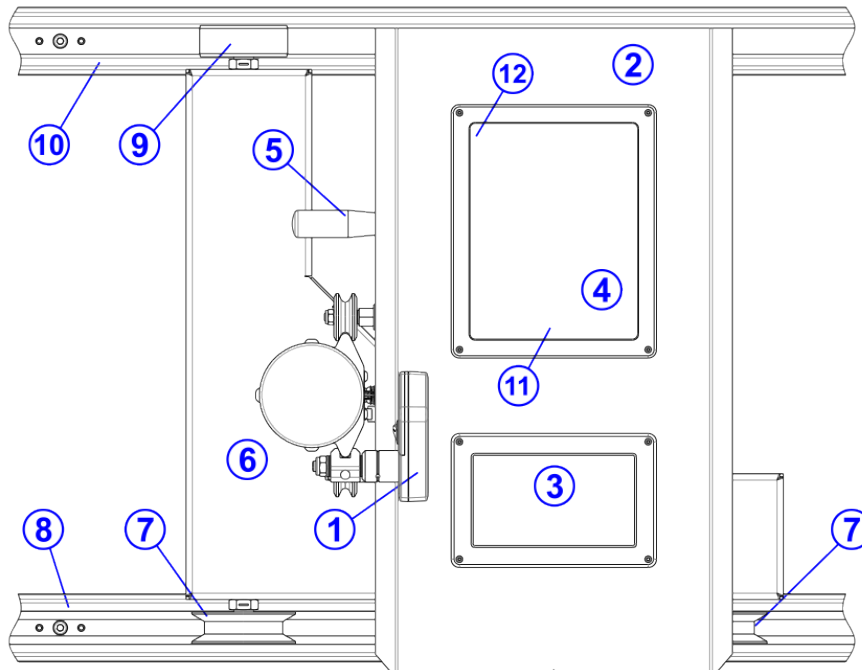

Figure 34: Top view Luminoscope® SLA 40 DR

#	Part	Description
1	Green alignment laser	Used to align the optical axis of the optical block with the longitudinal axis of the vehicle.
2	Optical block	The optical block includes a lens, a white projection screen, a digital camera, a control panel and a connector plate. Captures, processes and analyzes the headlight beam projection.

#	Part	Description
3	Control panel	Control panel with 7" colour touch screen to operate the system and to visualize the headlight image.
4	Perspex window	The headlight image on the projection screen inside the optical block is visible through this window.
5	Handle	Handle on the vertical sliding table to move the system and vertically displace the optical block.
6	Trolley base	The trolley base on wheels ensures the stability and the perpendicularity of the system.
7	V-wheel with eccentric axle	Front wheel guides the system on the hexagonal rail. Provided with an eccentric axis which allows the vertical adjustment of the stand.
8	Adjustable hexagonal rail profile	Adjustable hexagonal rail profile embedded in the floor, which guides the two front V-wheels of the trolley base.
9	Flat wheel with eccentric axle	Flat wheel running on the square rail. Provided with an eccentric axis which allows for the vertical adjustment of the stand.
10	Adjustable square rail profile	Adjustable square rail profile embedded in the floor, on which the rear flat wheel of the trolley base runs.

## SLA 40 SR

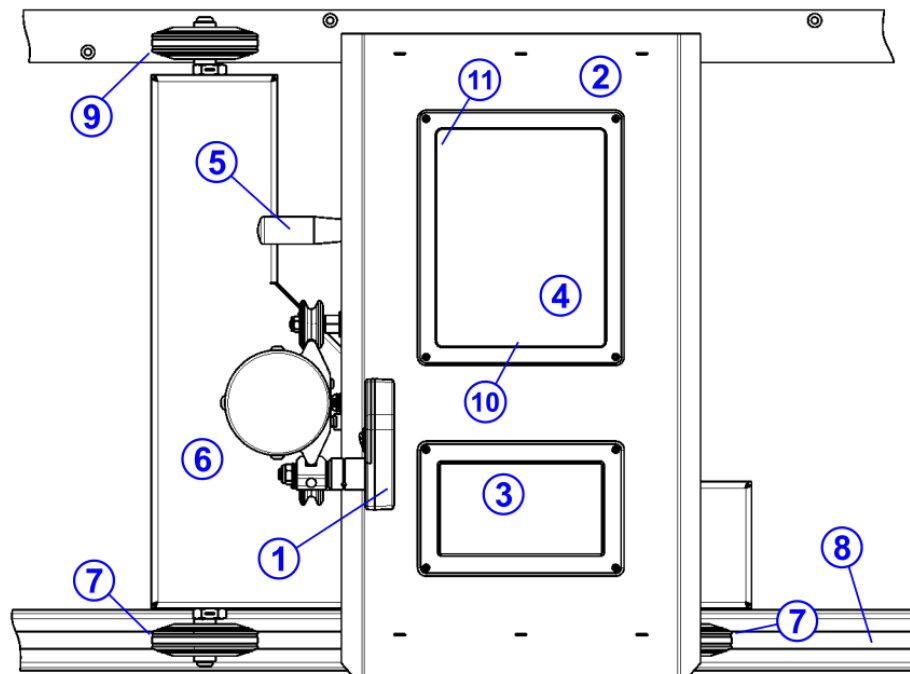

Figure 35: Top view Luminoscope® SLA 40 SR

#	Part	Description
1	Green alignment laser	Used to align the optical axis of the optical block with the longitudinal axis of the vehicle.

#	Part	Description
2	Optical block	The optical block includes a lens, a white projection screen, a digital camera, a control panel and a connector plate. Captures, processes and analyzes the headlight beam projection.
3	Control panel	Control panel with 7" colour touch screen to operate the system and to visualize the headlight image.
4	Perspex window	The headlight image on the projection screen inside the optical block is visible through this window.
5	Handle	Handle on the vertical sliding table to move the system and vertically displace the optical block.
6	Trolley base	The trolley base on wheels ensures the stability and the perpendicularity of the system.
7	Rubber wheel with eccentric axle	The rubber wheel runs on a non-adjustable rail profile. Provided with an eccentrical axis which allows the vertical adjustment of the stand.
8	Non-adjustable rail profile	Non-adjustable rail profile mounted on the floor. The two front rubber wheels of the trolley base are guided on the rail.
9	Rubber wheel with eccentric axle	The rubber wheel runs on the floor. Provided with an eccentrical axis which allows the vertical adjustment of the stand.
10	Special guiding rail	Special rail profile mounted on the floor, not supplied by LET. May be adjusted to ensure a flat continuous surface. Requires matching wheels which are available in the LET catalog.

SLA 40 NR

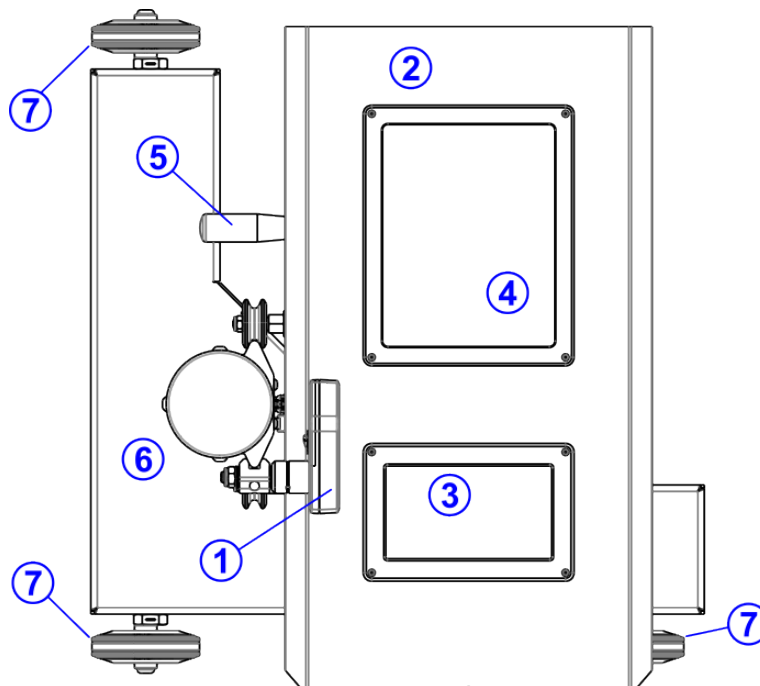

Figure 36: Top view Luminoscope® SLA 40 NR

#	Part	Description
1	Green alignment laser	Used to align the optical axis of the optical block with the longitudinal axis of the vehicle.
2	Optical block	The optical block includes a lens, a white projection screen, a digital camera, a control panel and a connector plate. Captures, processes and analyzes the headlight beam projection.
3	Control panel	Control panel with 7" colour touch screen to operate the system and to visualize the headlight image.
4	Perspex window	The headlight image on the projection screen inside the optical block is visible through this window.
5	Handle	Handle on the vertical sliding table to move the system and vertically displace the optical block.
6	Trolley base	The trolley base on wheels ensures the stability and the perpendicularity of the system.
7	Rubber wheel with eccentric axle	The rubber wheel runs on the floor. Provided with an eccentric axis which allows the vertical adjustment of the stand.

5.3.3 Left side view

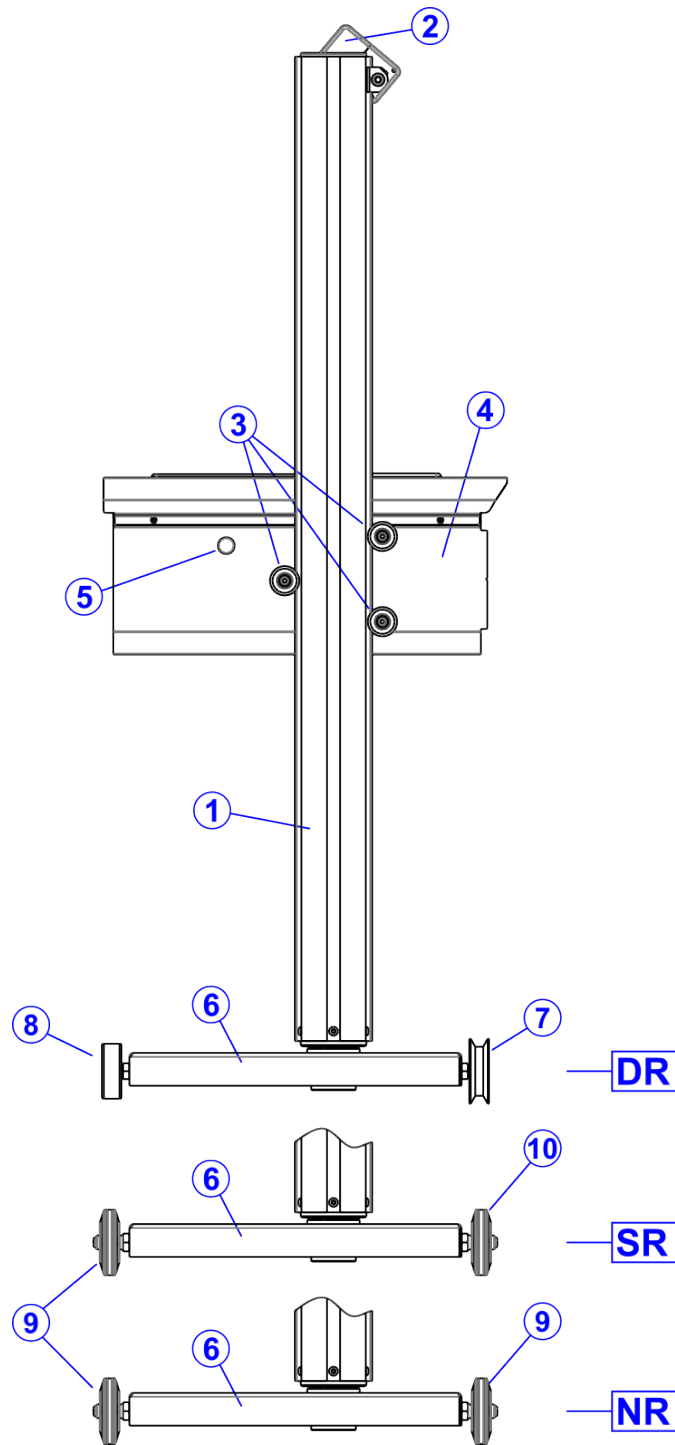

Figure 37: Left side view Luminoscope® SLA 40

#	Part	Description
1	Stand	The optical block is attached to the vertical fins of the stand.
2	Green alignment laser	Used to align the optical axis of the optical block with the longitudinal axis of the vehicle.
3	Vertical V-wheels	V-wheels sliding vertically on the fins of the column.

#	Part	Description
4	Optical block	The optical block includes a lens, a white projection screen, a digital camera, a control panel and a connector plate. Captures, processes and analyzes the headlight beam projection.
5	Handle	Handle on the vertical sliding table to move the system and vertically displace the optical block.
6	Trolley base	The trolley base on wheels ensures the stability and the perpendicularity of the system.
7	V-wheel with eccentric axle	Front wheel guides the system on the hexagonal rail. Provided with an eccentric axis which allows the vertical adjustment of the stand.
8	Flat wheel with eccentric axle	Flat wheel running on the square rail. Provided with an eccentric axis which allows for the vertical adjustment of the stand.
9	Rubber wheel with eccentric axle	The rubber wheel runs on the floor. Provided with an eccentric axis which allows the vertical adjustment of the stand.
10	Rubber wheel with eccentric axle	The rubber wheel runs on a non-adjustable rail profile. Provided with an eccentric axis which allows the vertical adjustment of the stand.

### 5.3.4 Right side view

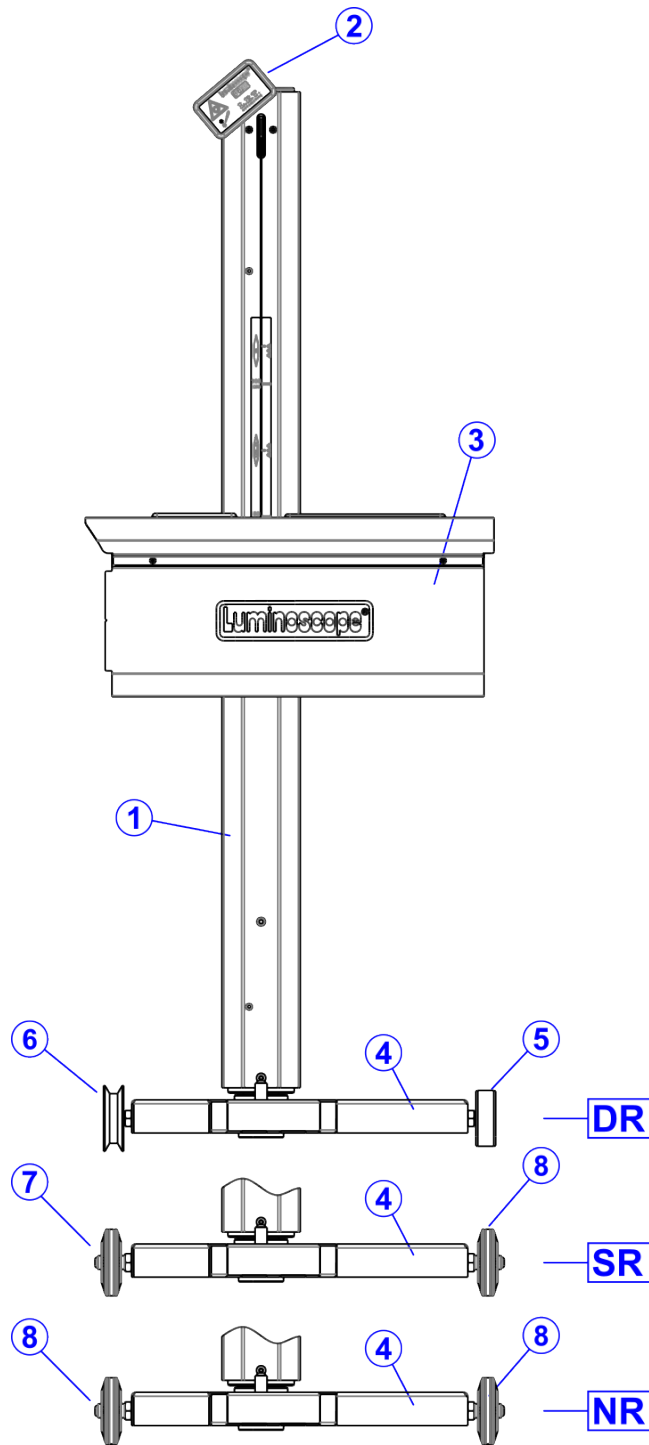

Figure 38: Right view Luminoscope® SLA 40

#	Part	Description
1	Stand	The optical block is attached to the vertical fins of the stand.
2	Green alignment laser	Used to align the optical axis of the optical block with the longitudinal axis of the vehicle.

#	Part	Description
3	Optical block	The optical block includes a lens, a white projection screen, a digital camera, a control panel and a connector plate. Captures, processes and analyzes the headlight beam projection.
4	Trolley base	The trolley base on wheels ensures the stability and the perpendicularity of the system.
5	Flat wheel with eccentric axle	Flat wheel running on the square rail. Provided with an eccentric axis which allows for the vertical adjustment of the stand.
6	V-wheel with eccentric axle	Front wheel guides the system on the hexagonal rail. Provided with an eccentric axis which allows the vertical adjustment of the stand.
7	Rubber wheel with eccentric axle	The rubber wheel runs on a non-adjustable rail profile. Provided with an eccentric axis which allows the vertical adjustment of the stand.
8	Rubber wheel with eccentric axle	The rubber wheel runs on the floor. Provided with an eccentric axis which allows the vertical adjustment of the stand.

### 5.3.5 Rear view

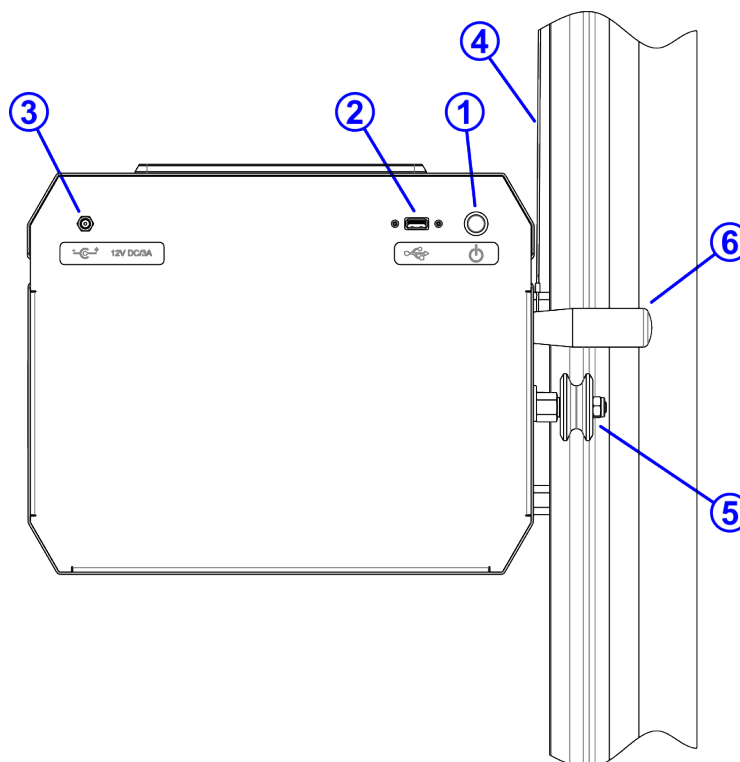

Figure 39: Rear view of the Luminoscope®

#	Part	Description
1	Power button with control light	Switches the optical block ON and OFF. Press the button 1 second to switch on the system or to recover from stand-by mode. Press the button 4 seconds to reset the system (cold start). The control light blinks to indicate the charging status of the battery.

#	Part	Description
2	USB connector	Multipurpose USB port. Usually fits a WiFi dongle and is useful for network connection and system backup or upgrade. Additionally it can connect to an optional LET-supplied multipurpose USB hub providing ethernet, serial or barcode integration.
3	12 VDC charging connector	The internal battery pack of the optical block can be charged with the supplied 12 VDC/60 W adaptor.
4	Counterweight cable	Connects the optical block with the counterweight inside the stand.
5	Vertical V-wheels	V-wheels sliding vertically on the fins of the column.
6	Handle	Handle on the vertical sliding table to move the system and vertically displace the optical block.

### 5.3.6 Alignment laser

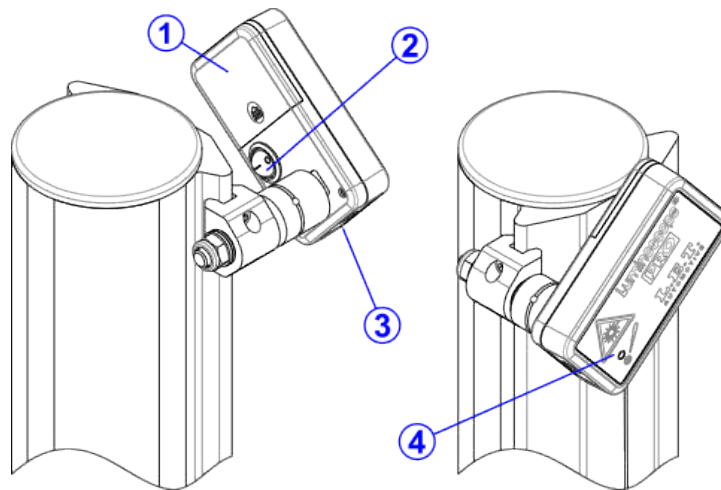
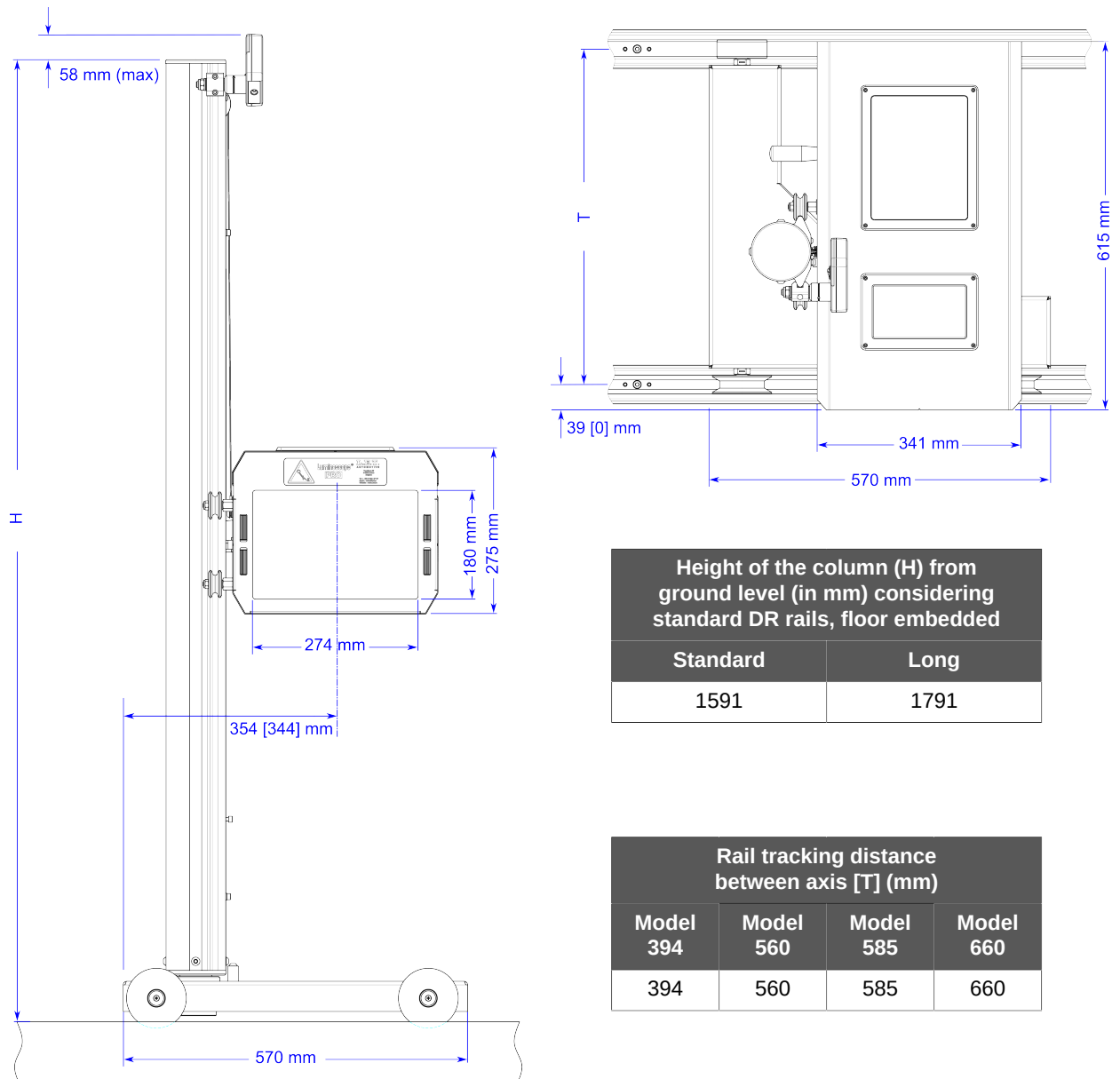

Figure 40: Alignment laser assembly

#	Part	Description
1	Battery lid	Remove it for substituting the laser batteries (2x AA alkaline cells, 1,5V).
2	Laser On-Off switch	Controls the power for the green alignment laser.
3	Green alignment laser	Used to align the optical axis of the optical block with the longitudinal axis of the vehicle.
4	Laser alignment screw	Access for an internal screw controlling the perpendicularity of the line laser beam.

## 5.4 Dimensions

### 5.4.1 SLA 40 DR



Height of the column (H) from ground level (in mm) considering standard DR rails, floor embedded

Standard	Long
1591	1791

Rail tracking distance between axis [T] (mm)

Model 394	Model 560	Model 585	Model 660
394	560	585	660



**Note:** Dimensions between brackets apply to wide-trolley models.

### 5.4.2 SLA 40 SR

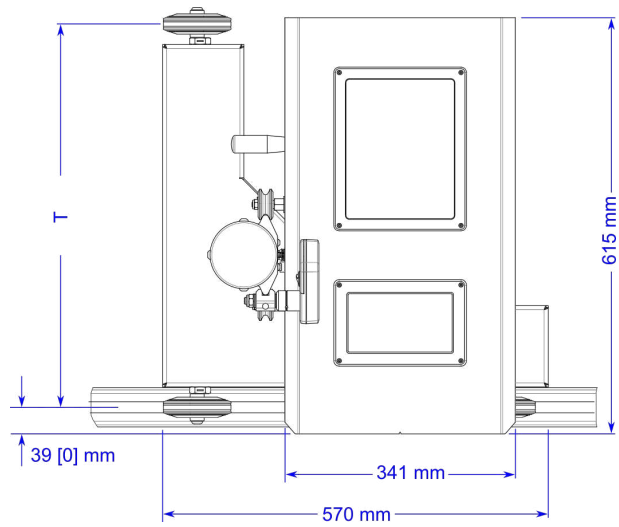
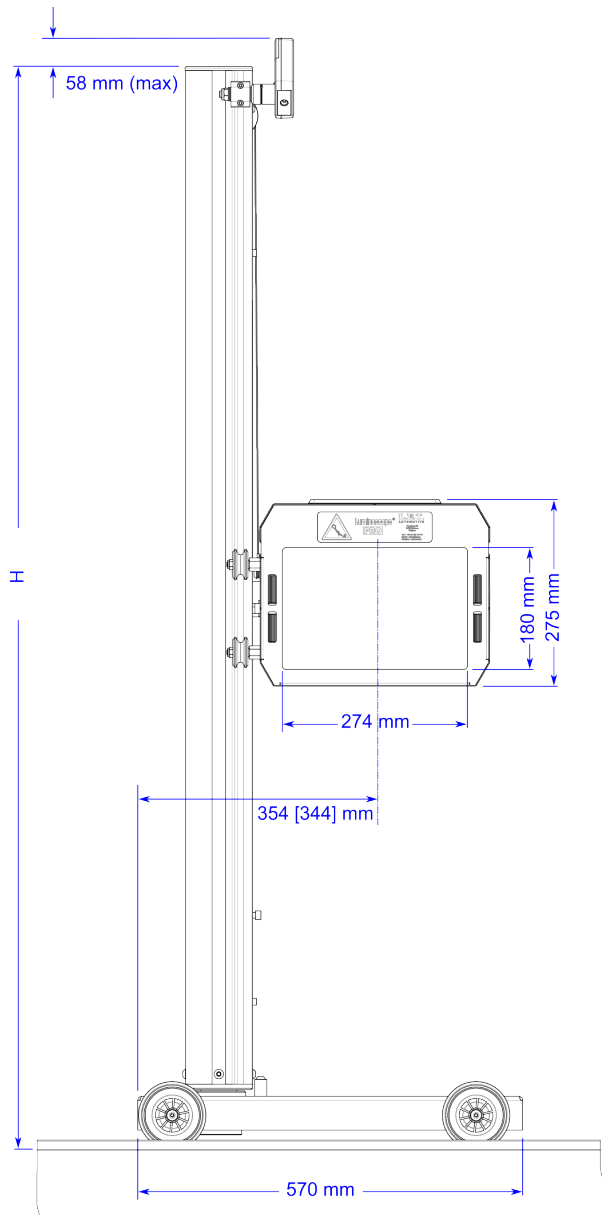

Height of the column (H) from ground level (in mm)	
Standard	Long
1604	1804

Rail tracking distance between axis [T] (mm)
Model 560
567



**Note:** Dimensions between brackets apply to wide-trolley models.

## 5.4.3 SLA 40 NR

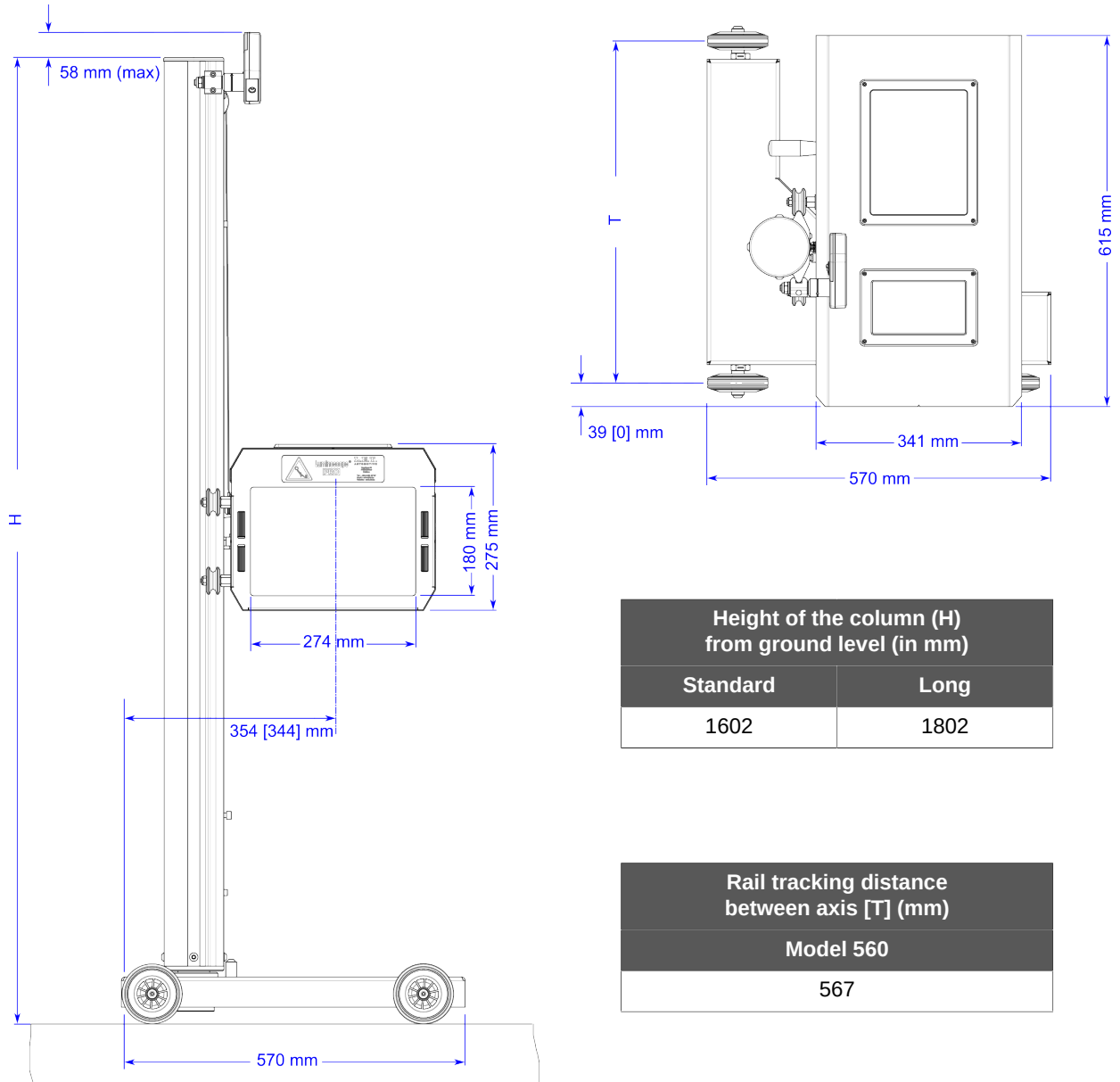

**Note:** Dimensions between brackets apply to wide-trolley models.

## 5.5 Datasheet

Models	Luminoscope® SLA 40 DR	Double Rail
	Luminoscope® SLA 40 SR	Single Rail
	Luminoscope® SLA 40 NR	No Rail
Headlamp assessment type	Digital (CMOS camera)	
Headlamp adjustment type	Manual adjustment	
Luminous intensity	Range	0 - 250 kCd
	Accuracy below 10 kCd	±10 %
	Accuracy over 10 kCd	±2 kCd
Testing range	Up	0 - 10 %
	Down	0 - 10 %
	Left	0 - 10 %
	Right	0 - 10 %
Measurement tolerance		±1 cm/10m
		±0,1 %
Measurement resolution		1 cm/10m
		0,1 %
Measuring distance between headlamp and Luminoscope® lens		200 - 600 mm
Vertical positioning range, measured from lens center to ground. Range may extend slightly further. Depends on rail type and eccentric position.	SLA 40 standard column	≈ 230 - 1300 mm
	SLA 40 long column	≈ 230 - 1500 mm
Distance between tracks	SLA 40 DR / SLA 40 DR-D	394 / 560 / 585 / 660 mm
Device for horizontal alignment	Alignment laser on top of the stand	
Measuring range for <i>ESL</i> (Electronic Spirit Level) module	Pitch and roll angle	±2 %
Dimensions	See drawings on previous pages.	
Weight		≈ 45 kg
Operating temperature range		+10 to +35 °C
Storage temperature range		0 to +40 °C
Relative humidity		less than 80 %
Optical block internal battery	Technology	LiFePO <sub>4</sub> (or Lithium-ion) cells
	Voltage	3,2 VDC
	Capacity	32 Ah
	Continuous operating time	over 24 h
	Charger voltage	12 VDC
	Charger power	60 W
	Charging cycle	12 h
	Alignment laser battery	Technology
	Voltage	2x 1,5 VDC
	Continuous operating time	10 h
Interfaces	LAN <sup>1</sup>	1 Gbps
	WLAN	WPA2 / 802.11bgn
	Serial <sup>1</sup>	RS232
	USB	v2

---

<sup>1</sup> Provided via optional converter, available via LET.



# 6 Power management

This chapter explains the details on the power-on and off cycle, showing how to switch the Luminoscope® on for normal use and how to switch it off when required.

It also explains the *standby mode* and how to wake the system up after inactivity.

Finally the *auto power-off* feature and the *system reset* are explained.

## 6.1 Switching the Luminoscope® ON and OFF

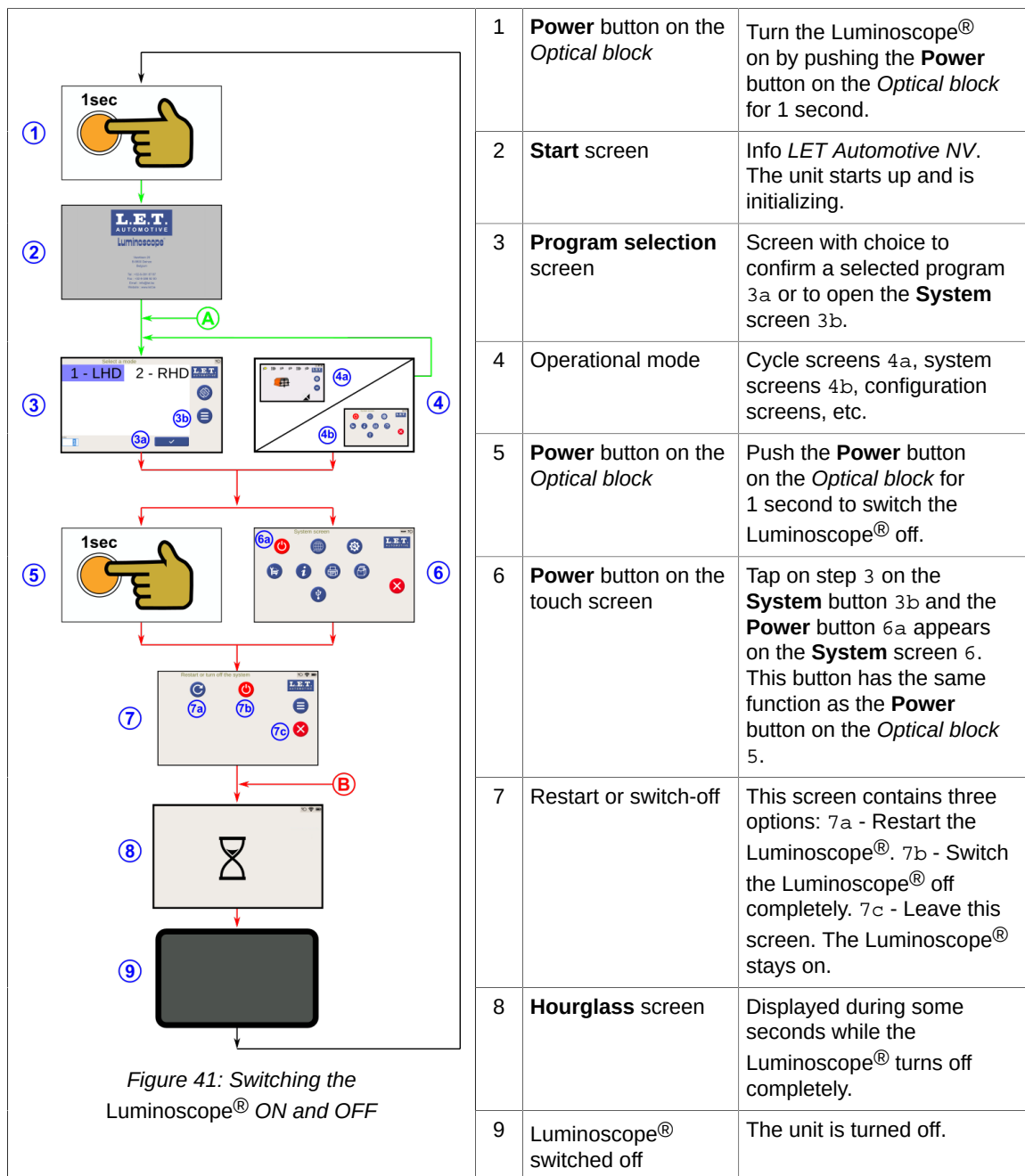

Figure 41: Switching the Luminoscope® ON and OFF

## 6.2 Power standby

	10	Standby timer	When the Luminoscope® is turned on but not used for a while (no button pressed, no lamp measured, etc.), it will switch to <i>standby mode</i> after a configurable time.
	11	Standby mode	When the Luminoscope® enters the <i>standby mode</i> , the LCD screen turns dark instantaneously, but the unit is not switched off.
	12	<b>Power</b> button on the <i>Optical block</i>	Wake the Luminoscope® up by pushing the <b>Power</b> button on the <i>Optical block</i> for 1 second. The <b>Program selection</b> screen 3 pops up immediately.
	13	Touch the screen	Wake the Luminoscope® up by pushing a random place on the LCD screen. The <b>Program selection</b> screen 3 pops up immediately.

## 6.3 Inactivity timer

In addition to the *standby mode* discussed in previous chapter, there is also an integrated timer feature that fully turns the unit off after a configurable longer inactivity period (*auto switch off* function).

<p>Figure 42: Automatically switching the Luminoscope® OFF</p>	14	Inactivity timer	<p>If the Luminoscope® is turned on but not used for a while (no button pressed, no lamp measured, etc.), it automatically switches to <i>standby mode</i>, darkening the LCD screen.</p> <p>If the inactivity period extends for a longer time, the Luminoscope® will be switched off completely. The Luminoscope® can be switched on again by pushing the <b>Power</b> button on the <i>Optical block</i> 1 on the connector panel of the optical block.</p>
--	----	------------------	--

## 6.4 Forced shut down of the Luminoscope®

This function provides a hardware power-off to be used only in cases of an unexpected operation.

	15	Forced shutdown	Pressing the <b>Power</b> button on the <i>Optical block</i> for a time longer than 4 seconds will switch off the system immediately. This should only be used in case the system is blocked as a result of an unexpected operation.
---	----	-----------------	--



---

# 7 Operation

---

The main purpose of the Luminoscope® is to measure specific headlamp beam characteristics such as horizontal beam position, vertical beam position, beam intensity, etc. There are different headlamp algorithms available for measuring the headlamp characteristics of different headlamp types. Based on the chosen algorithm, a number of the headlamp beam characteristics will be measured.

Most of the headlamp algorithms can be used either for adjusting the headlamp beam position or for checking the headlamp beam position. This means there are two different approaches for a test cycle:

- Headlamp aiming cycle: The position of the headlamp beam should be aimed (adjusted) to a pre-defined target position. An *aiming tolerance zone* around the target position allows the operator to adjust the headlamp correctly.
- Headlamp audit cycle: The position of the headlamp beam should be evaluated to check whether it is within the pre-defined *audit tolerance zone*.









The audit tolerance zone is in most cases determined by the government regulations. The *aiming tolerance zone* should always be smaller than the *audit tolerance zone*. This to ensure that a correctly aimed headlamp in a workshop (using the smaller *aiming tolerance zone*) will pass the test in a government inspection station (using the larger *audit tolerance zone*).

## 7.1 Test cycle references

There is a number of topics related with the test sequence which apply to many of its steps. They are collected below and will be used as a reference along the explanation of the test cycle.

### 7.1.1 Beam icons

Each low beam, high beam and fog beam has its specific beam icon on the cycle screens. Next table explains the meaning of the icons and the different statuses.

Icon	Beam	Status description
	Low beam	Headlamp under test (test not yet started).
	High beam	
	Fog beam	
	Low beam	Headlamp position inside tolerance. The tolerance overlay on the headlamp image is green-colored.
	High beam	
	Fog beam	
	Low beam	Headlamp position outside tolerance. The tolerance overlay on the headlamp image is red-colored.
	High beam	
	Fog beam	

Similarly, each low beam, high beam and fog beam has its specific beam icon on the **Beam selection** screen.



**Note:** Depending on the configuration of the Luminoscope®, the **Beam selection** screen is displayed.

The following table explains the meaning of the icons and the different statuses.

Icon	Beam	Status description
	Low beam	Headlamp not yet tested.
	High beam	
	Fog beam	
	Low beam	Headlamp position inside tolerance.
	High beam	
	Fog beam	
	Low beam	Headlamp position outside tolerance.
	High beam	
	Fog beam	

After the test, the system displays a datablock including the test results next to the corresponding beam icon on the **Beam selection** screen, regardless of the positive or negative test results.

Icon	Status description
 X = -0.06 % Y = -0.90 % I = 6.7 kCd H = +800 mm	Approved headlamp with measurement results
 X = 0.06 % Y = -2.88 % I = 6.8 kCd H = +800 mm	Rejected headlamp with measurement results

The datablocks for the results of each tested beam include the following information:

Value	Description
X	Horizontal beam measurement position (Left/Right)
Y	Vertical beam measurement position (Up/Down)
I	Intensity
H	Mounting height of the headlamp



**Note:** Depending on the chosen algorithm and configuration of the system, the number of results so as the units may vary.

## 7.1.2 Left / right vehicle side definition

The left and right sides of the vehicle are always defined from the driver's point of view.

Headlamps which are located on the left side (as seen from the driver's point of view) are called the *left headlamps*, and those on the right side are called the *right headlamps*.

The touch screen of the Luminoscope® SLA 40 optical block can be rotated 180° by pressing the **Rotate screen** button.

Consequently there are two possible screen orientations. One is better suited for checking headlamps and the other is preferred for adjusting headlamps.

Screen orientation mode	Description
Checking headlamps	The operator is standing behind the Luminoscope® system, looking towards the front of the vehicle and the touch screen.
Adjusting headlamps	The operator is standing nearby the zone between the Luminoscope® system and the front of the vehicle and is looking towards the lens of the Luminoscope® and the touch screen.

Rotating the screen position affects to the position of the beam icons and the beam selection buttons on the screen. The intelligence of the Luminoscope® automatically places the beam icons and beam selection buttons on the correct side of the vehicle. For both screen orientation modes, the beam icons and beam selection buttons which are closer to the left side of the vehicle are applicable for the headlamps on the left side. Those closer to the right side of the vehicle are applicable for the headlamps on the right side.

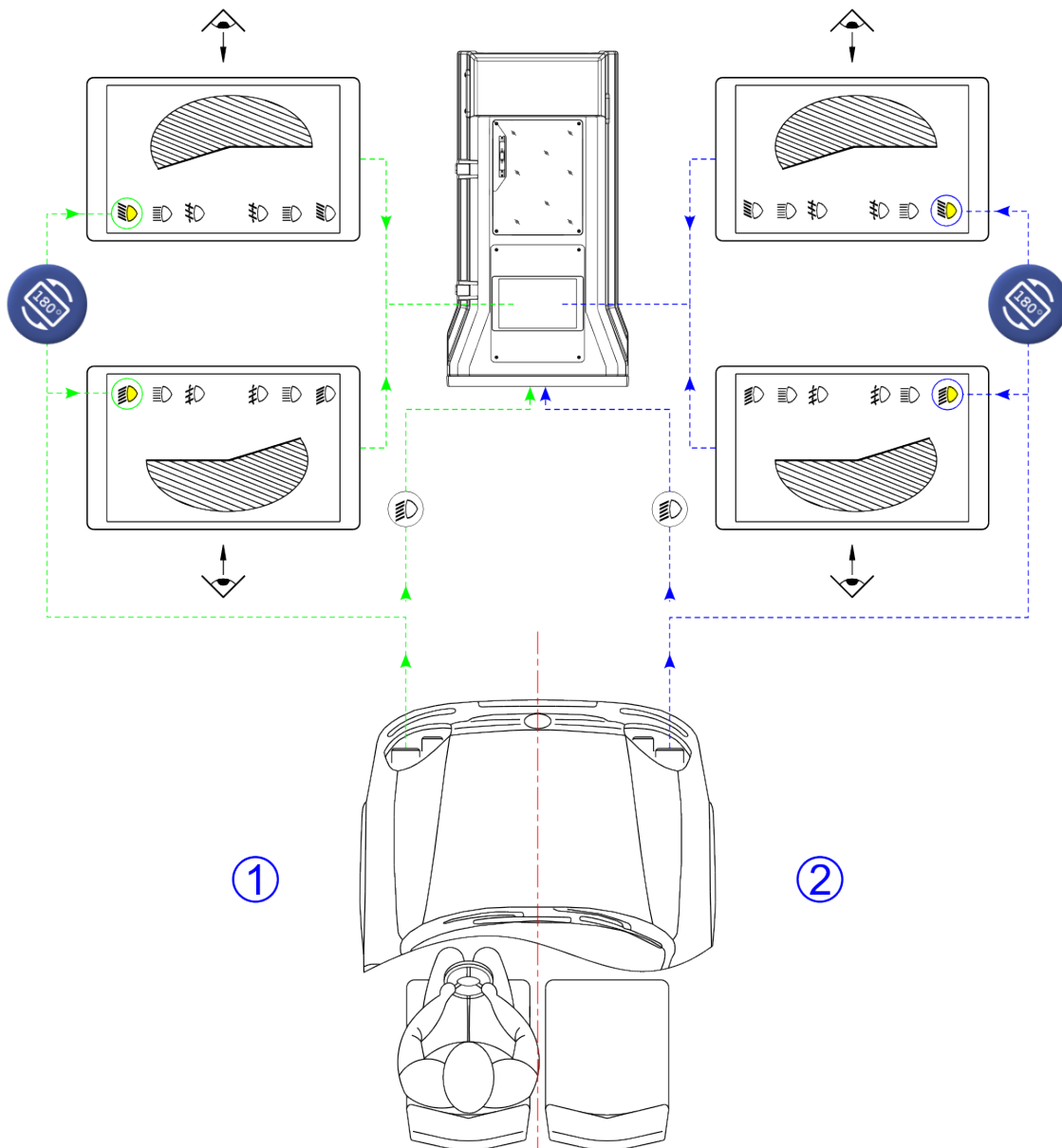

Figure 43: Left / right vehicle side definition

#	Description
1	Left side of the vehicle
2	Right side of the vehicle

### 7.1.3 Alignment with the vehicle

Before each cycle starts, it is necessary to align the optical axis of the headlamp tester with the longitudinal axis or driving direction of the vehicle, in order to minimize the measurement result error in the horizontal direction.

Before each test cycle starts, it is necessary to align the longitudinal direction of the vehicle with the longitudinal direction of the vehicle standing area, as the longitudinal axis of the headlamp tester is calibrated parallel with the longitudinal direction of the vehicle standing area. For the vehicle alignment either use a drive in guiding system, painted guiding lines on the floor, a wheel aligner system, a centraliser system, a vehicle alignment measurement (VAM) system, etc.

### 7.1.3.1 Alignment laser

Use the green alignment laser on top of the stand to align the Luminoscope® system with the longitudinal axis of the vehicle.

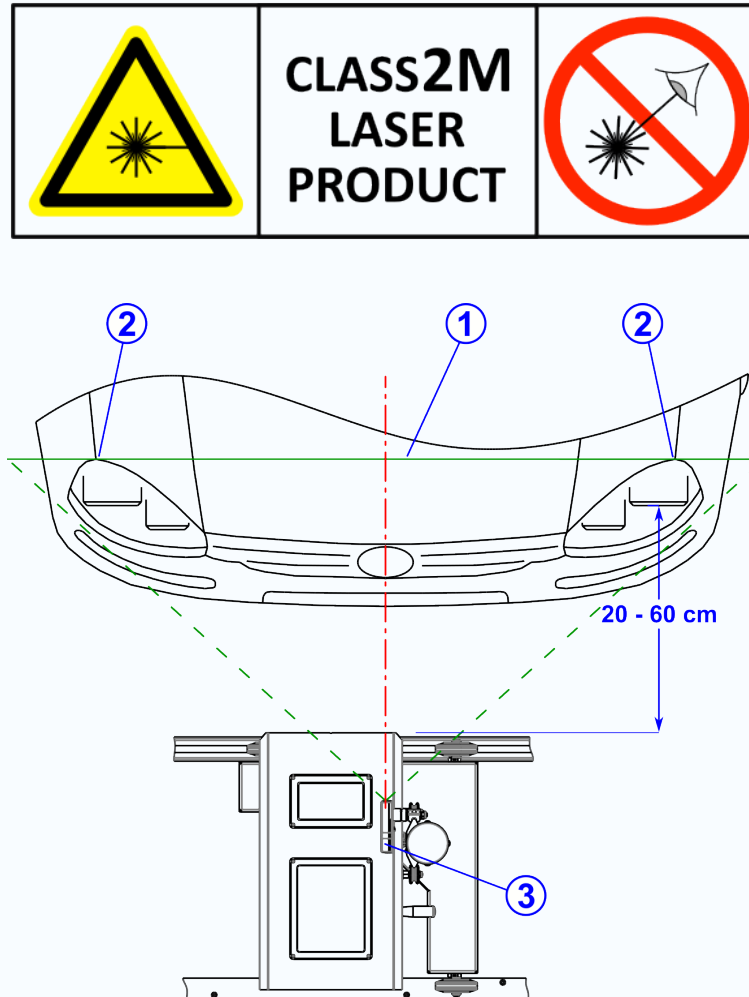

Figure 44: Use of alignment laser to align the Luminoscope® with vehicle longitudinal axis

1. Move the Luminoscope® to the middle of the vehicle. Skip this step for the SLA 40 NR model.



**Attention:** In case of the SLA 40 NR model, the alignment should be performed for each vehicle side separately, i.e. once for the left headlamps and once for the right headlamps.

2. Power the laser **ON** with the corresponding switch. The laser remains powered until it is switched off.
3. Tilt the laser until its beam 1 is projected at the front of the vehicle.



**Attention:** Do not forget to switch the laser **OFF** in order to preserve its batteries' life.

4. Rotate the stand until the laser beam 1 intersects two symmetrical points 2 of the vehicle.

The two symmetrical points should be as far apart as possible, close to the vehicle sides, in order to maximize the precision of the alignment.

Some bodywork colours may cause too much color absorption. In this case, open the front hood and project the laser beam on two symmetrical points at the inside.

### 7.1.3.2 Linear alignment

Some car builders specify an alignment procedure based in the specific setup of the test bay, practically avoiding the use of dedicated or additional instrumentation.

The procedure requires a line painted on the ground. This line is parallel to the optical axis of the Luminoscope® and has a length of about 7 meters.

Beside of that, a mirror is generally installed beside of the Luminoscope® and allows the driver to see the marking line while driving the vehicle in place.

1. Drive the vehicle into the test bay.
2. Follow the marking line on the ground with the front left wheel.



**Tip:** If available, use the mirror with the line to check the vehicle trajectory and the position of the wheel regarding the marking on the ground.

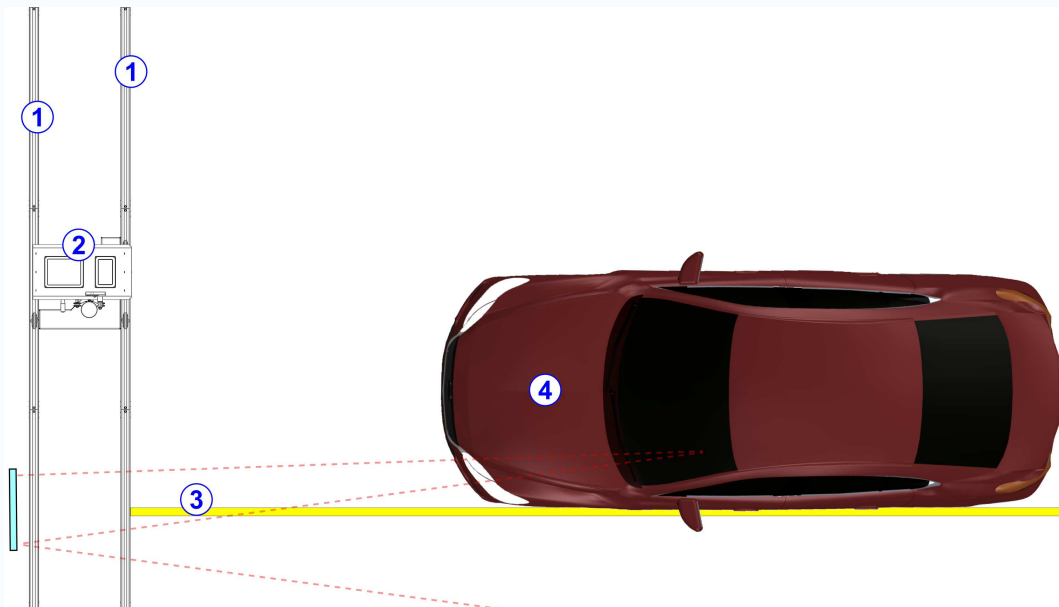

Figure 45: Example of a guiding line on the ground

#	Description
1	Lateral movement rails.
2	Optical block of the Luminoscope®.

#	Description
3	Yellow reference line, parallel to the optical block axis.
4	Vehicle under test.
5	Optional mirror assisting the vehicle driver for its proper alignment.

3. Be sure that the front wheel is aligned with the marking on the ground and within a tolerance of 2 mm.

Make sure that the distance from the vehicle to the optical block is inside the standard range (200 - 600 cm).

### 7.1.4 Positioning in front of the headlamp

It is of great importance that the lens of the Luminoscope® is correctly positioned in front of the headlamp to ensure that as many light rays as possible enter the lens.

This guarantees that the beam image is displayed realistically on the white projection screen inside the Luminoscope® to be able to perform a correct headlamp measurement.

With this purpose, the Luminoscope® system is provided with the electronic *Position Check* system that uses four solar cells around the lens 1.

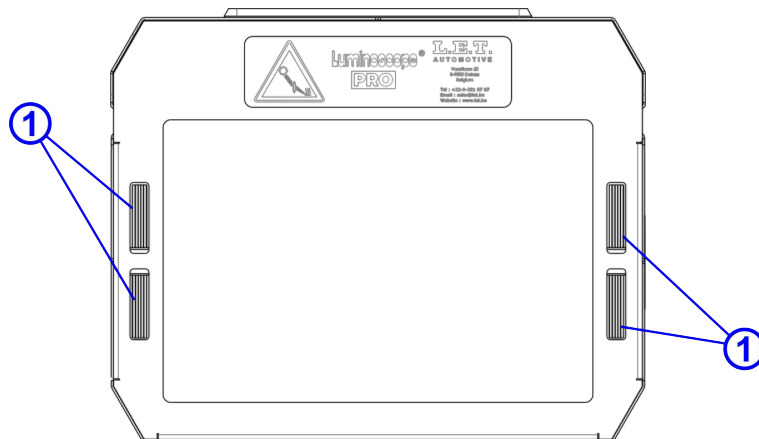

Figure 46: Position Check cells around the lens

The electronic *Position Check* system guides the operator to the optimal position for measuring the headlamp beam by means of four *Position Check* arrows 2. Once the optimal position is reached, all *Position Check* arrows 2 disappear and the headlamp measurement starts automatically.



Figure 47: Position Check Arrows on control panel screen

In some situations, it is not possible to reach an optimal position in front of the headlamp using the *Position Check*. This could be caused, for example, because of a very wide headlamp beam. In such a case, the alignment operation can be done manually.

The operator positions the Luminoscope® in front of the headlamp by moving the optical block vertically and horizontally (without rotating the stand) and by simultaneously looking on the beam projection on the white projection screen inside the optical block. When the beam projection looks as expected, tap on the **Skip Position Check** button 3 to start the headlamp measurement.

### 7.1.5 Mounted height of the headlamp

Headlamp mounting height is critical for low beam, high beam and fog lamps aiming and testing. Local regulations define specific scenarios, as detailed below.



**Note:** Check the following information against local regulations before performing any tests.

#### Related information

[Mounted height of the headlamp](#) (pg. 66)

#### 7.1.5.1 Standard definition

The vertical target values and the vertical aiming and audit tolerances for European LHD and RHD low beams depend on the mounted height of the low beam. The targets and tolerances are defined in the *ECE R48* standard (part of *ECE 324* standard).

The *ECE R48* standard doesn't provide any information about the horizontal aiming or audit tolerances.



**Note:** Target and tolerances are defined by local regulations and may vary from those explained below.

The standard defines four height ranges or zones for low beams:

Zone	Height range	Application
0,8 m > height	Lower than 0,8 m	These zones are typically used for workshop and inspection station equipment.
1,0 m ≥ height ≥ 0,8 m	Between 0,8 m and 1,0 m	
1,2 m ≥ height > 1,0 m	Higher than 1,0 m and not over 1,2 m	
Height > 1,2 m	Higher than 1,2 m	Reserved for some special vehicles such as off-road or military vehicles.

The specific vertical audit tolerance values for the different height zones are explained in the diagram below. The coloured hatched areas are the initial vertical aiming tolerances as defined by the *ECE R48* regulation.

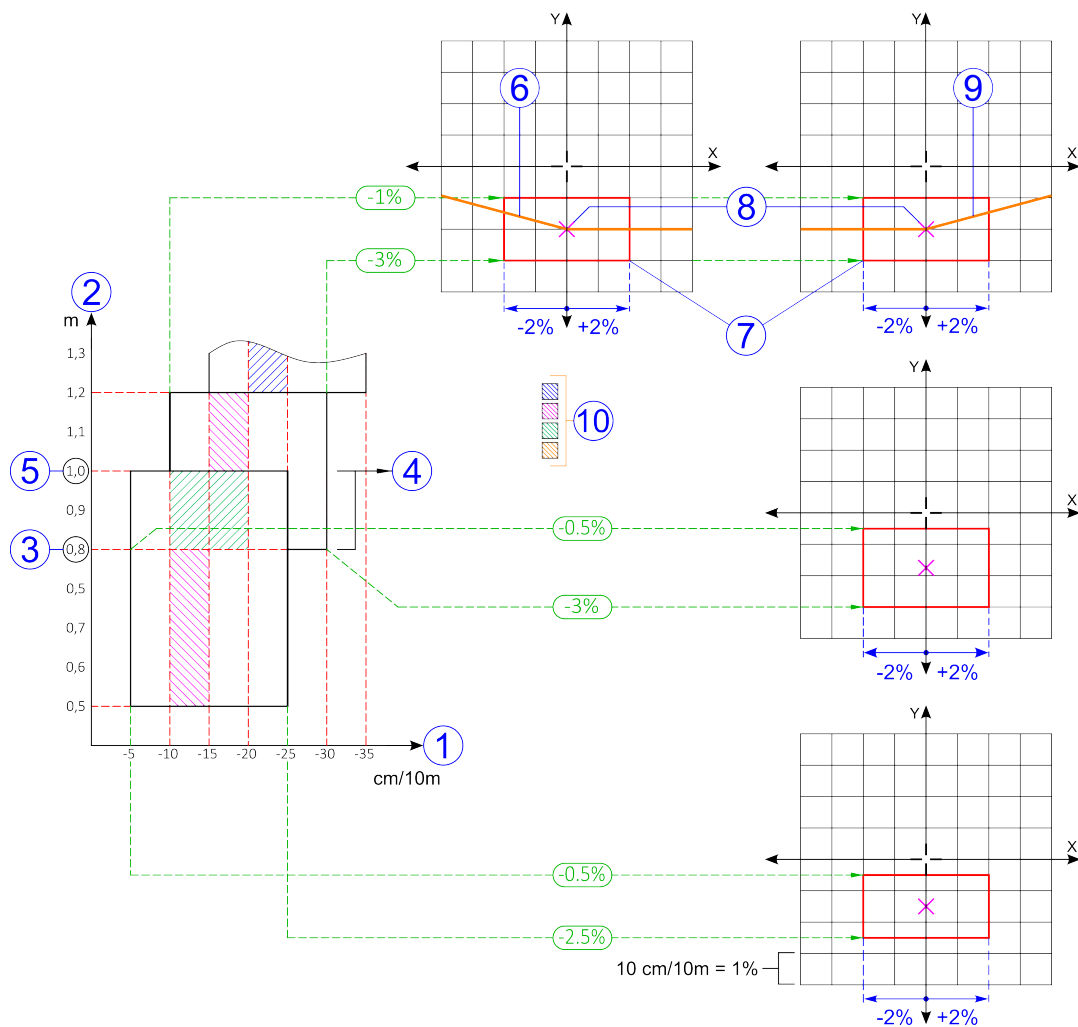

Figure 48: Vertical audit and aiming tolerance window depending on the mounting height of the low beam

#	Description
1	Horizontal axis. Vertical inclination value for an European LHD or RHD low beam in cm/10m.
2	Vertical axis. Mounted height of the low beam in meter.
3	Low beam mounting height of 0,8 m.

#	Description
4	Low beam mounting height between 0,8 m and 1,0 m.
5	Low beam mounting height of 1,0 m.
6	RHD low beam cut-off line simulation.
7	Audit tolerance window.
8	Measurement reference of the low beam cut-off line (V-point).
9	LHD low beam cut-off line simulation.
10	Vertical tolerance window for initial low beam aiming.

The higher the mounted height of the low beam, the lower the low beam inclination should be.

The next table shows an overview of the four *height zones* with the corresponding vertical aiming and audit tolerance window:

Low beam mounting height	Vertical audit tolerance window for low beam	Vertical aiming tolerance window for low beam
Up to 0,8 m	-5 cm/10m till -25 cm/10m	-10 cm/10m till -15 cm/10m
From 0,8 to 1,0 m	-5 cm/10m till -30 cm/10m	-10 cm/10m till -20 cm/10m
More than 1,0 and less than 1.2 m	-10 cm/10m till -30 cm/10m	-15 cm/10m till -20 cm/10m
Higher than 1,2 m	-15 cm/10m till -35 cm/10m	-20 cm/10m till -25 cm/10m

At the start of each headlamp measurement and in order to select the corresponding vertical tolerance zone, it is necessary to determine the mounting height of the headlamp. For this purpose, the optical block has to be properly aligned in front of the headlamp, with the assistance of the *Position Check* system.

The cursor upper side 2 of the height indicator 1 on the sliding table, shows the exact mounting height of the headlamp, according to the reading on the sticker 3 on the stand.

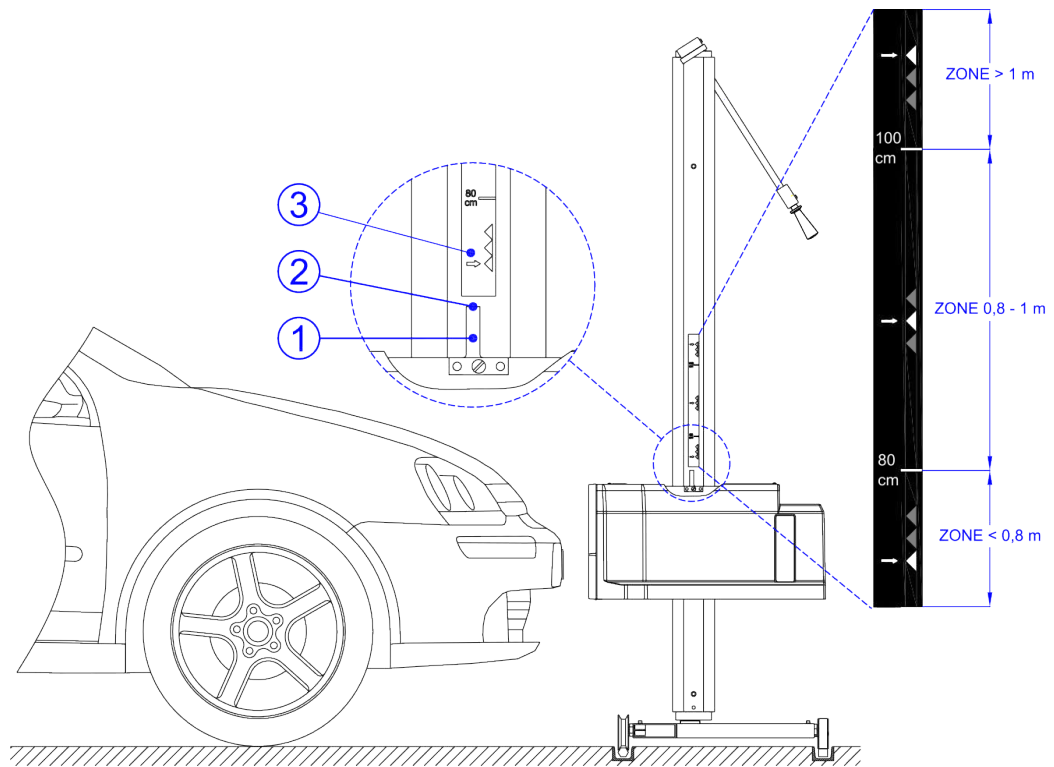

Figure 49: Height selection

After correctly positioning the Luminoscope® in front of the headlamp by using the *Position Check* system, the *Position Check Arrows 4* should all disappear as on the image underneath. At this point, one of the three height area buttons 5 should be tapped and the correct aiming or audit tolerance window will be automatically applied.

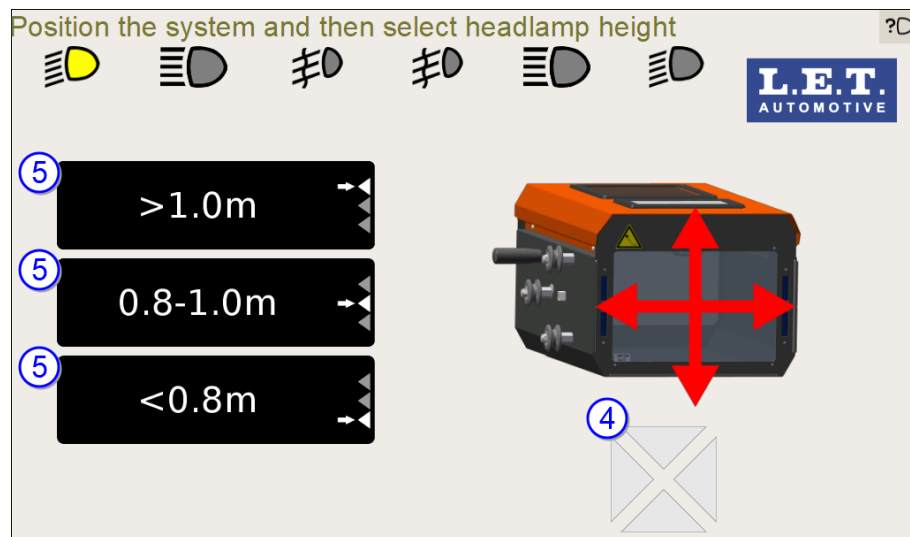

Figure 50: Lamp height area selection

**Note:** The height selection step should only be done before the first low beam measurement in the cycle. The second low beam in the cycle automatically uses the same defined height zone.

This principle is also valid for the high and fog beams.

**Related information**

[Mounted height of the headlamp \(pg. 66\)](#)

**7.1.5.2 For DVSA units**

British regulations define specific scenarios for headlamp mounting height, as detailed below.

The target Y values and tolerances for low, high, and fog beams depend on the lamp's mounting height (see tables below).

**Low beam tolerances**

CAR			TRUCK		
Z2 (+850mm)	Target X [%]	-1,00	Target X [%]	-1,00	
	Target Y [%]	-2,00	Target Y [%]	-2,63	
	Aim tol. Up	0,30	Aim tol. Up	0,30	
	Aim tol. Down	0,30	Aim tol. Down	0,30	
	Aim tol. Left	0,50	Aim tol. Left	0,50	
	Aim tol. Right	0,50	Aim tol. Right	0,50	
	Audit tol. Up	0,75	Audit tol. Up	1,38	
	Audit tol. Down	0,75	Audit tol. Down	1,38	
	Audit tol. Left	9,00	Audit tol. Left	9,00	
	Audit tol. Right	1,00	Audit tol. Right	1,00	
Z1 (-850mm)	Target X [%]	-1,00	Target X [%]	-1,00	
	Target Y [%]	-1,63	Target Y [%]	-2,25	
	Aim tol. Up	0,30	Aim tol. Up	0,30	
	Aim tol. Down	0,30	Aim tol. Down	0,30	
	Aim tol. Left	0,50	Aim tol. Left	0,50	
	Aim tol. Right	0,50	Aim tol. Right	0,50	
	Audit tol. Up	1,13	Audit tol. Up	1,75	
	Audit tol. Down	1,13	Audit tol. Down	1,75	
	Audit tol. Left	9,00	Audit tol. Left	9,00	
	Audit tol. Right	1,00	Audit tol. Right	1,00	

## High beam tolerances

CAR		
Z2 (+850mm)	Target X [%]	0,00
	Target Y [%]	-1,00
	Aim tol. Up	0,30
	Aim tol. Down	0,30
	Aim tol. Left	0,50
	Aim tol. Right	0,50
	Audit tol. Up	2,00
	Audit tol. Down	2,00
	Audit tol. Left	3,00
	Audit tol. Right	3,00
Z1 (-850mm)	Target X [%]	0,00
	Target Y [%]	-0,63
	Aim tol. Up	0,30
	Aim tol. Down	0,30
	Aim tol. Left	0,50
	Aim tol. Right	0,50
	Audit tol. Up	2,00
	Audit tol. Down	2,00
	Audit tol. Left	3,00
	Audit tol. Right	3,00

TRUCK		
Z2 (+850mm)	Target X [%]	0,00
	Target Y [%]	-1,63
	Aim tol. Up	0,30
	Aim tol. Down	0,30
	Aim tol. Left	0,50
	Aim tol. Right	0,50
	Audit tol. Up	2,00
	Audit tol. Down	2,00
	Audit tol. Left	3,00
	Audit tol. Right	3,00
Z1 (-850mm)	Target X [%]	0,00
	Target Y [%]	-1,25
	Aim tol. Up	0,30
	Aim tol. Down	0,30
	Aim tol. Left	0,50
	Aim tol. Right	0,50
	Audit tol. Up	2,00
	Audit tol. Down	2,00
	Audit tol. Left	3,00
	Audit tol. Right	3,00

## Fog beam tolerances

CAR			TRUCK		
Z2 (+850mm)	Target X [%]	0,00	Z2 (+850mm)	Target X [%]	0,00
	Target Y [%]	-3,00		Target Y [%]	-3,63
	Aim tol. Up	0,30		Aim tol. Up	0,30
	Aim tol. Down	0,30		Aim tol. Down	0,30
	Aim tol. Left	0,50		Aim tol. Left	0,50
	Aim tol. Right	0,50		Aim tol. Right	0,50
	Audit tol. Up	2,00		Audit tol. Up	2,00
	Audit tol. Down	2,00		Audit tol. Down	2,00
	Audit tol. Left	2,00		Audit tol. Left	2,00
	Audit tol. Right	2,00		Audit tol. Right	2,00
Z1 (-850mm)	Target X [%]	0,00	Z1 (-850mm)	Target X [%]	0,00
	Target Y [%]	-2,63		Target Y [%]	-3,25
	Aim tol. Up	0,30		Aim tol. Up	0,30
	Aim tol. Down	0,30		Aim tol. Down	0,30
	Aim tol. Left	0,50		Aim tol. Left	0,50
	Aim tol. Right	0,50		Aim tol. Right	0,50
	Audit tol. Up	2,00		Audit tol. Up	2,00
	Audit tol. Down	2,00		Audit tol. Down	2,00
	Audit tol. Left	2,00		Audit tol. Left	2,00
	Audit tol. Right	2,00		Audit tol. Right	2,00

## Determination of the height zone

To set the correct height zone for each headlamp (low, high, fog):

- Use the position check arrows 3 on the **Height selection** screen to position the optical block in front of the headlamp.
- Read the headlamp's height zone from the column sticker and press the corresponding button 2 on the **Height selection** screen. This selects the correct tolerance window for the lamp's calculated position.

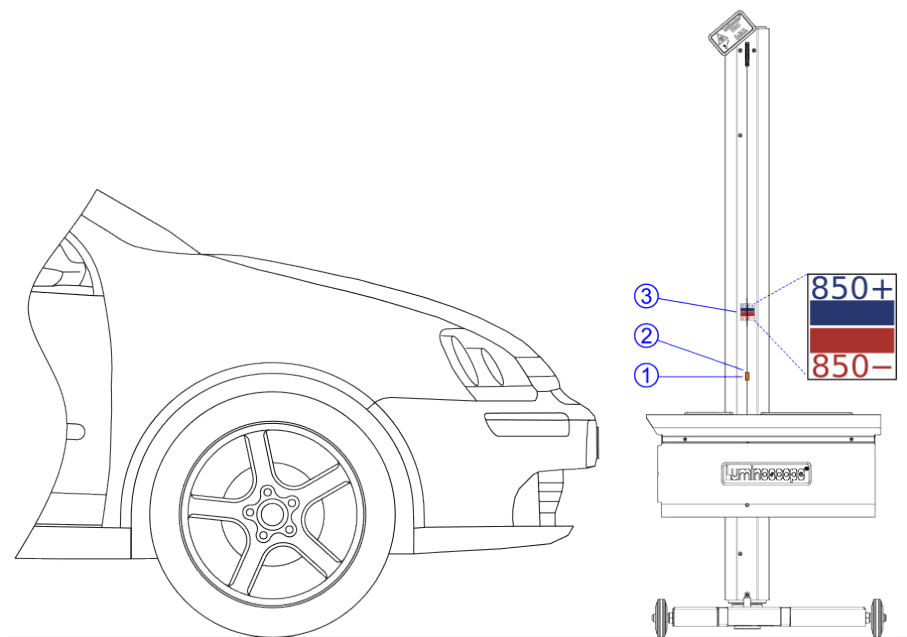

Figure 51: Lamp height determination

#	Id	Description
1	Cursor	Cylindrical adjustable cursor attached to the steel cable.
2	Upper side of the cursor	Determines the height of the optical block continuously as compared against the height label.
3	Height sticker label	Defines and delimits the two operating height zones: +850mm and -850mm.

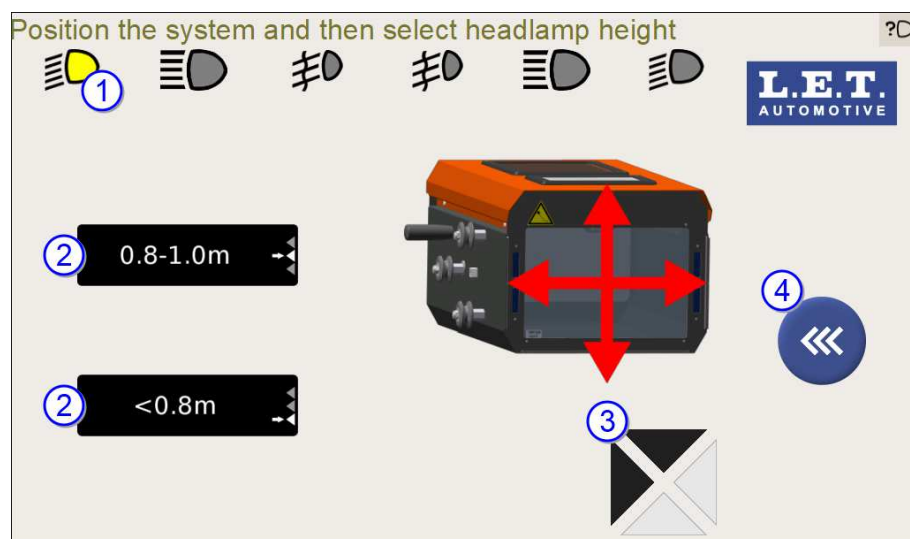

Figure 52: **Height selection** screen

#	Id	Description
1	Lamp under test	The lamp under test is highlighted in yellow.

#	Id	Description
2	Height zones	Select an area based on the headlamp's height. (See next page for details.)
3	<i>Position Check Arrows</i>	Once the optical block is in front of the headlamp, photoelectric cells capture the beam's light. Positioning indicators then illuminate, showing the direction to move the block for optimal alignment. Read the height on the column's height sticker after achieving optimal position.
4	<b>Back</b> button	Return to the previous screen.

### Related information

[MOT inspection manual: cars and passenger vehicles](#)

## 7.1.6 ESL - Electronic Spirit Level module

The Luminoscope® is provided with an on-board electronic level or *ESL* (Electronic Spirit Level).

It's unavoidable that the pitch angle and roll angle of the optical block of systems with non-adjustable rails or without any rails will vary while displacing the system. This has a direct consequence on the headlamp measurement results. As a solution, the Luminoscope® SLA 40 is equipped with an *ESL*.

The purpose of the *ESL* is to automatically take into account the pitch and roll angle of the optical block to ensure an accurate headlamp measurement. The headlamp measurement result is automatically compensated with the real time angular measurement of the *ESL*.

Before each headlamp measurement starts, the pitch (inclination) and roll angle of the optical block is measured by the *ESL*. As the Luminoscope® SLA 40 was moved, the *ESL* needs a short period to stabilize its angular measurement. The image underneath is shown as long as the *ESL* is stabilising. The icon of the *ESL* shows some "shivering" by means of two lines above and below the icon 1. At the same time the measured pitch and roll angle of the *ESL* are displayed 2.



Figure 53: *ESL*: data not stable

As soon as the *ESL* is stabilised, the screen disappears and the actual headlamp measurement starts automatically. The angular measurement values of the *ESL* are taken automatically into account. In case the Luminoscope® is (slightly) moved or shaken during the headlamp

measurement, the *ESL* performs a new angular measurement and the above screen is displayed again. As soon as the *ESL* has been stabilised, the headlamp measurement resumes.

If however the pitch or roll angle exceed  $\pm 2,00\%$ , a warning message appears indicating that the spirit level is out of range. In this case the headlamp measurement cannot start.

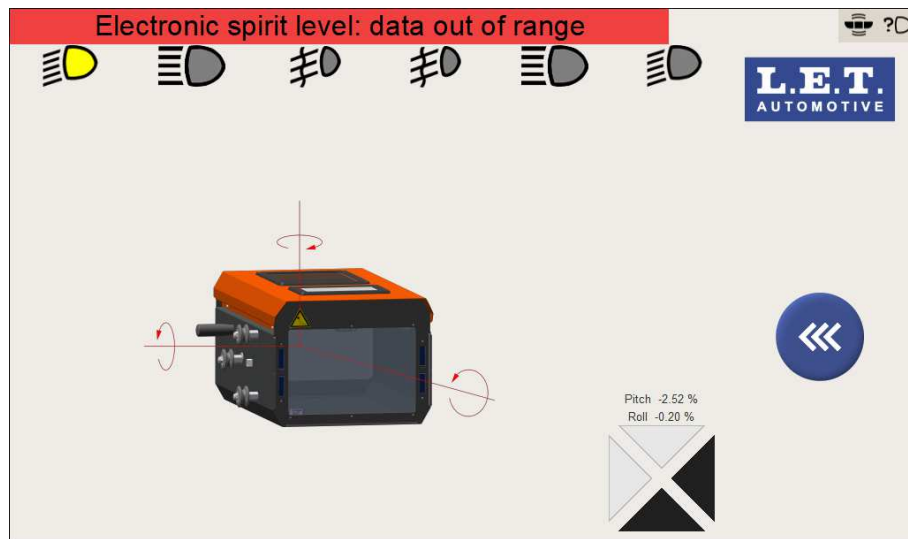

Figure 54: ESL: data out of range

## 7.2 Test cycle sequence

This chapter explains the different steps that should be followed in a test cycle. Based on the Luminoscope® configuration or the selected program, a test cycle could be a headlamp aiming cycle or a headlamp audit cycle.



**Note:** The test cycle could look slightly different depending on the Luminoscope® configuration or selected program which could be based on different regulations.

Step number	Step description	Comments
1	Switching on the Luminoscope®	The Luminoscope® should be properly charged and switched on.
2	Alignment with the vehicle	The Luminoscope® should be properly aligned with the longitudinal axis (driving direction) of the vehicle.
3	Program selection	The <b>Program selection</b> screen displays different selectable test modes, which allow the operator to select among a number of pre-configured test cycles.
4	Line selection	The <b>Line selection</b> screen displays up to nine test lines from which the operator can choose. Each test line has a preset name and slope of the vehicle standing area. The screen is only displayed when more than one test line is defined.
5	Beam selection	The <b>Beam selection</b> screen provides buttons for the selection of the required beam and vehicle side.

Step number	Step description	Comments
6	Selection of mounted headlamp height	The <b>Height selection</b> screen shows the different headlamp mounting height zones for each beam type (low, high and fog beam) separately. At the start of each headlamp measurement, it is necessary to determine the mounting height of the headlamp in order to select the corresponding vertical tolerance zone.
7	Positioning in front of the headlamp	Before the headlamp measurement can start, it is required that the Luminoscope® is correctly positioned in front of the headlamp by means of the electronic <i>Position Check</i> system.
8	ESL (Electronic Spirit Level) module compensation	The <i>ESL</i> (Electronic Spirit Level) module automatically takes into account the pitch and roll angles of the optical block to ensure an accurate headlamp measurement.
9	Beam measurement	The digital camera inside the Luminoscope® captures, processes and analyzes the headlamp beam projection.
10	Overview beam measurement results	When all tests are completed, the <b>Beam selection</b> screen displays all beam measurement results.
11	Test cycle reports and data transmission	Depending on the configuration of the Luminoscope®, the measurement results can be stored on the system ( <i>PDF</i> format), printed on a paper ticket or transmitted to an external device using one of the communication protocols.













### 7.2.1 Switching on the Luminoscope®

The Luminoscope® should be properly charged and switched on.

1. Switch on the Luminoscope®.

2. Make sure the Luminoscope® is properly charged.

Look at the battery status icon in the top right corner of the screen.

Connected	Disconnected	Battery status description
		Fully charged.
		Charge level between 100% and 75%.
		Charge level between 75% and 50%.
		Charge level between 50% and 25%.
		Charge level below 25%.
		Very low charge level.
		Battery disconnected.

Connected	Disconnected	Battery status description
		Charge too low for operation.



**Warning:** Do not connect the charger in case the rechargeable battery is not connected or broken.

#### Related tasks

[System restarting and power-off](#) (pg. 192)

### 7.2.2 Alignment with the vehicle

The Luminoscope® should be properly aligned with the longitudinal axis (driving direction) of the vehicle.

Use the green alignment laser on top of the column to align the Luminoscope® with the longitudinal axis of the vehicle.



#### Attention:

- In case the Luminoscope® is used on a rail guiding system (e.g. SLA 40 SR – Single Rail or SLA 40 DR – Double Rail), the column should not be rotated during the cycle, particularly when moving the Luminoscope® from one side of the vehicle to the other side.
- In case the Luminoscope® is NOT used on a rail guiding system (e.g. SLA 40 NR – No rail), the alignment procedure should be performed separately for each headlamp on the left and right sides of the vehicle.

#### Related information

[Alignment with the vehicle](#) (pg. 62)

### 7.2.3 Alignment with the vehicle for units fitted with optional bolt-aligner

The longitudinal direction (driving direction) of the vehicle should be properly aligned with the longitudinal axis of the Luminoscope®. For the vehicle alignment either use a drive in guiding system, painted guiding lines on the floor, a wheel aligner system, a centralizer system, a vehicle alignment measurement (VAM) system, etc.

#### Related information

[Alignment with the vehicle](#) (pg. 62)

## 7.2.4 Program selection

The **Program selection** screen displays different selectable test modes, which allow the operator to select among a number of pre-configured test cycles.

Depending on the customer specific configuration, the **Program selection** screen can either display:

- a list with different selectable test modes, or
- a screen with different test mode selection buttons. This screen can take different forms depending on markets and customers, as described in the following chapters.

### 7.2.4.1 Program list

The following chapter explains the **Program selection** screen in the form of a list with different selectable test modes.

 **Note:** The screen may have a different appearance depending on the customer's specific implementation.

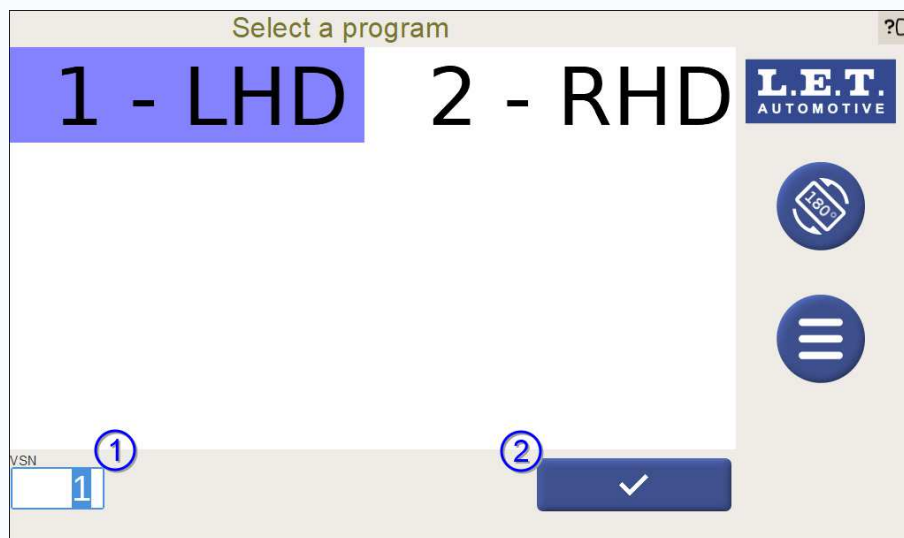



Figure 55: **Program selection** screen

1. Select the requested program by tapping on the **Program name** with the corresponding **Program number**.

 **Note:** The selected program number appears at the left bottom corner of the screen in the VSN (Vehicle Selection Number) field 1.

2. Tap on the **Select program** button 2.

 **Note:** Alternatively the program selection can also be remotely initiated by a host computer, to start a test cycle by means of a specific communication protocol.

### 7.2.4.2 Program selection buttons (Standard)

The following chapter explains the standard **Program selection** screen in the form of a screen with different test mode selection modes.

**Note:** The screen may have a different appearance depending on the customer's specific implementation.

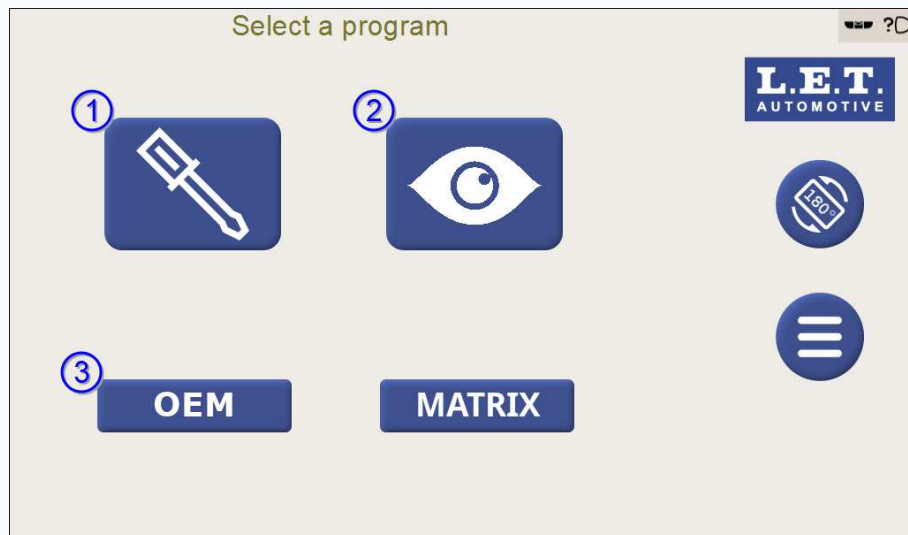

Figure 56: **Program selection** screen

#	Button	Description
1	<b>Aiming</b> button	The <b>Screwdriver</b> button refers to a headlamp aiming cycle. In a headlamp aiming cycle, the position of the headlamp beam should be aimed (adjusted) to a pre-defined target position. An aiming tolerance zone around the target position allows the operator to adjust the headlamp correctly.
2	<b>Audit</b> button	In a headlamp audit cycle, the position of the headlamp beam should be evaluated to check whether it is within the pre-defined audit tolerance zone. The audit tolerance zone is determined by the government regulations. The aiming tolerance zone should always be smaller than the audit tolerance zone. This to ensure that a correctly aimed headlamp in a workshop (using the smaller aiming tolerance zone) will pass the test in a government inspection station (using the larger audit tolerance zone).
3	<b>OEM</b> button	The <b>OEM</b> button refers to special Original Equipment Manufacturer sequences for various beam types.

Tap on one of the buttons for accessing the desired functionality:

- Tap on the **Aiming** button 1 to start a test in aiming mode.
- Tap on the **Audit** button 2 to start a test in audit mode.
- Tap on the **OEM** button 3 to enter the **OEM program selection** screen.

## Related tasks

[OEM test cycle sequences](#) (pg. 101)

### 7.2.4.3 Program selection screen for UK market

The following chapter explains the UK-specific **Program selection** screen in the form of a screen with different test mode selection modes.

 **Note:** The screen may have a different appearance depending on the customer's specific implementation.

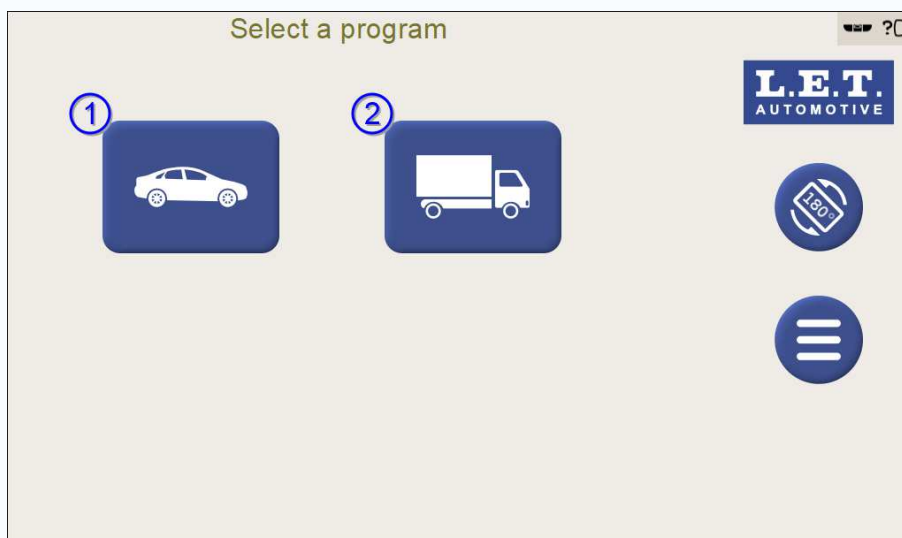

Figure 57: **Program selection** screen for UK market

#	Button	Description
1	<b>Car</b> button	The <b>Car</b> button prepares the Luminoscope® to test a car, by automatically loading the corresponding settings and tolerances.
2	<b>Truck</b> button	The <b>Truck</b> button prepares the Luminoscope® to test a truck, by automatically loading the corresponding settings and tolerances.

Tap on one of the buttons for accessing the desired functionality.

## 7.2.5 Line selection

The **Line selection** screen displays up to nine test lines from which the operator can choose. Each test line has a preset name and slope of the vehicle standing area. The screen is only displayed when more than one test line is defined.

These lines can be selected by the user in this screen, while its management (enable/disable status, configuration) is achieved via the web interface.

The slope of a vehicle standing area can be positive (the front axle of the vehicle is positioned higher than the rear axle), negative (the front axle of the vehicle is positioned lower than the rear axle) or zero (both front and rear axle of the vehicle are positioned at the same height).



**Note:**

- In case the device is only used at one location (only one test line), the **Line selection** screen is not displayed. However, the preset slope of the vehicle standing area of the first test line will be applied automatically to the beam measurement.
- The screen may have a different appearance depending on the customer's specific implementation.

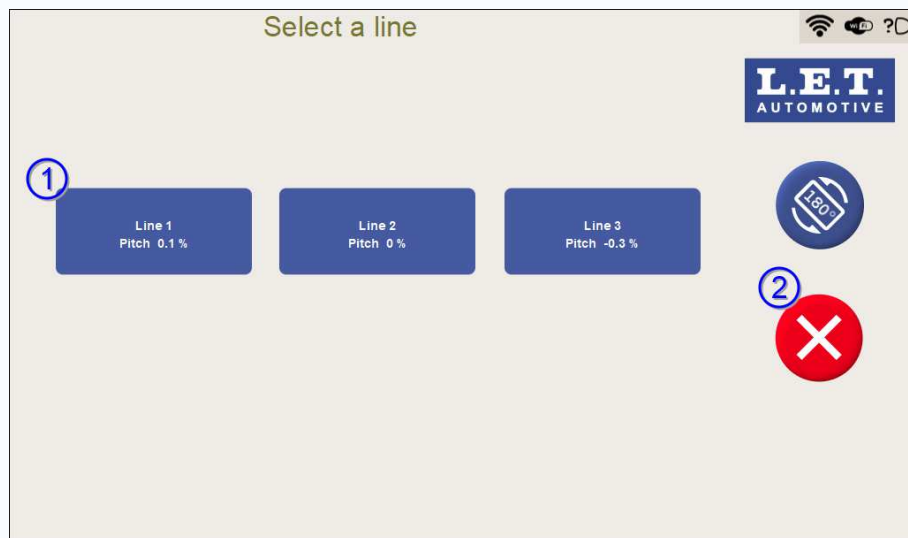

Figure 58: **Line selection** screen

#	Button	Description
1	Line selection	Select the test line. Each <b>Line selection</b> button shows the preset name and slope of the vehicle standing area.
2	Abort	Abort the test cycle and return to the <b>Program selection</b> screen.

Select the requested test line by tapping on the corresponding **Line selection** button.

The preset slope of the vehicle standing area will be applied automatically to the beam measurement.

**Related information**

[Web interface](#) (pg. 241)

## 7.2.6 Beam selection

There are different program types (sequences) that could be configured for a program.

- Free beam selection sequence: The operator is free to choose the next lamp to be tested by tapping a beam selection button on the **Beam selection** screen.
- Fixed beam selection sequence: The system shows the operator which lamp to test next.

The next program types are available at the **Program properties** screen:

- E\_CAR\_AIM: free sequence with possibility of live validation.
- E\_CAR\_AUDIT: free sequence without live validation.
- E\_CAR\_AIM\_ManFixLmpOrder: fixed sequence with possibility of live validation.
- E\_CAR\_AUDIT\_ManFixLmpOrder: fixed sequence without live validation.



**Note:** This setting is not available for the current access level. Please refer to a user who has the necessary permissions if this setting is required.

The next chapters explain the functionality of a free beam selection sequence and a fixed beam selection sequence.

### 7.2.6.1 Free beam selection sequence

In case of a free beam selection sequence, the **Beam selection** screen provides buttons for the selection of the required beam and vehicle side.

Select the desired beam by tapping on the corresponding button and vehicle side.



**Note:** The screen may have a different appearance depending on the customer's specific implementation.

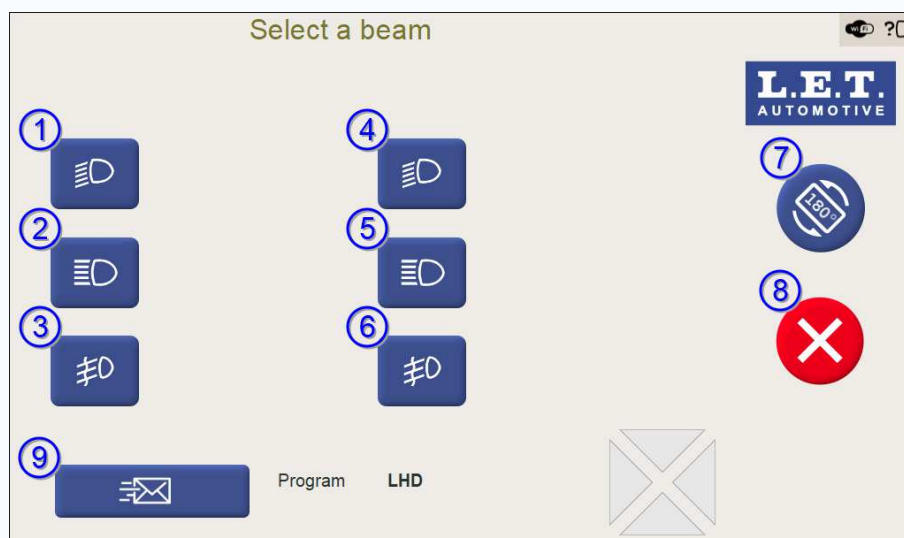

Figure 59: **Beam selection** screen

#	Button	Description
1	First low beam	Enable the test of the first low beam.
2	First high beam	Enable the test of the first high beam.
3	First fog beam	Enable the test of the first fog beam.
4	Second low beam	Enable the test of the second low beam.
5	Second high beam	Enable the test of the second high beam.
6	Second fog beam	Enable the test of the second fog beam.
7	Screen rotation	Change the screen orientation.
8	Abort	Abort the test cycle and return to the <b>Program selection</b> screen.
9	Send results	Store the measurement results of the test cycle. Depending on the configuration of the Luminoscope®, the measurement results can be stored on the system ( <i>PDF</i> format), printed on a paper ticket or transmitted to an external device using one of the communication protocols.



**Note:** Rotating the screen position affects to the position of the beam icons and beam selection buttons on the screen. The intelligence of the Luminoscope® automatically places the beam icons and beam selection buttons at the correct side of the vehicle. For both screen orientation modes, the beam icons and beam selection buttons which are closer to the left side of the vehicle are applicable for the headlamps on the left side. Those closer to the right side of the vehicle are applicable for the headlamps on the right side.

### Related information

[Left / right vehicle side definition](#) (pg. 61)

#### 7.2.6.2 Fixed beam selection sequence

In case of a fixed beam selection sequence, the system shows the operator which lamp to test next. The test order can be configured (in a string with number 1, 2, 3, 4, 5, 6) for each program.



**Attention:** The string should contain all six numbers, and each number only once. The numbers should be separated by a semicolon. The order can be set freely.

The next numbers (codes) are available:

Code	Description	Code	Description
1	Low beam left	4	Low beam right
2	High beam left	5	High beam right
3	Fog beam left	6	Fog beam right

e.g. *TestOrder* parameter: 1, 4, 5, 2, 3, 6

The example above results in the next test order: low beam left > low beam right > high beam right > high beam left > fog beam left > fog beam right.



**Note:**

- Tests that are set to `none` in the **Program properties** screen are not applicable for the program and will be skipped in the program sequence.
- This setting is not available for the current access level. Please refer to a user who has the necessary permissions if this setting is required.

The following screen is displayed as soon as the test sequence starts.



**Note:** The test order depends on the test order configuration. Consequently, the screen underneath may have a different appearance.

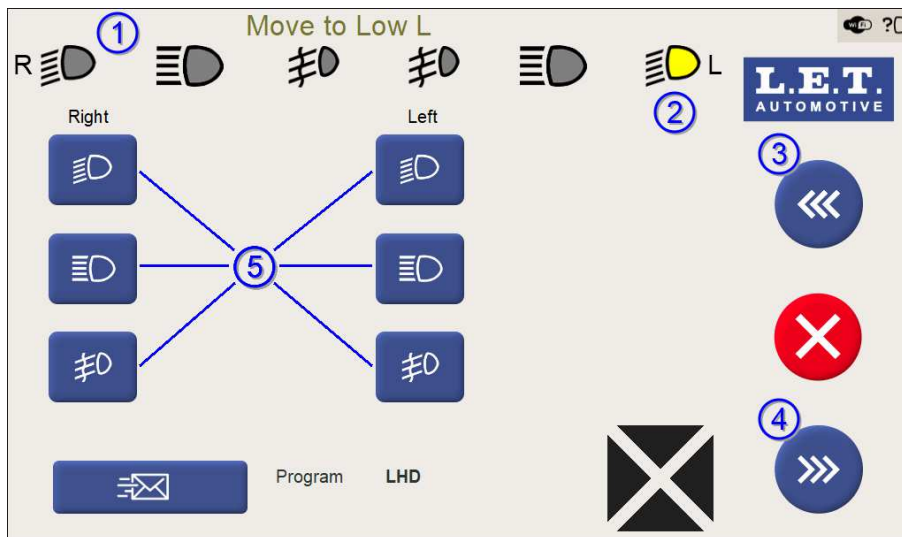

Figure 60: Move to low beam left

#	Element	Description
1	Information banner	Information banner with instructions for the operator. Move to [Name of headlamp].
2	Left low beam icon	Yellow marked left low beam icon means <i>Test in progress</i> .
3	<b>Return</b> button	Return to the previous test in the sequence.
4	<b>Next</b> button	Move to the next test in the sequence.
5	<b>Beam selection</b> button	Beam selection button for low beams, high beams and fog beams.

The operator should follow the movement instructions shown in the information banner 1.

Tapping a beam selection button 5 will make the sequence jump to that beam immediately, all previous beams in the test order will be skipped.

Tapping the **Return** button 3 will repeat the previous beam in the test order, while the **Next** button 4 will skip the current beam.

## 7.2.7 Selection of mounted headlamp height

The **Height selection** screen shows the different headlamp mounting height zones for each beam type (low, high and fog beam) separately. At the start of each headlamp measurement, it is necessary to determine the mounting height of the headlamp in order to select the corresponding vertical tolerance zone.

**Note:** The screen may have a different appearance, depending on the customer's specific implementation and on the local specific height zones regulations.

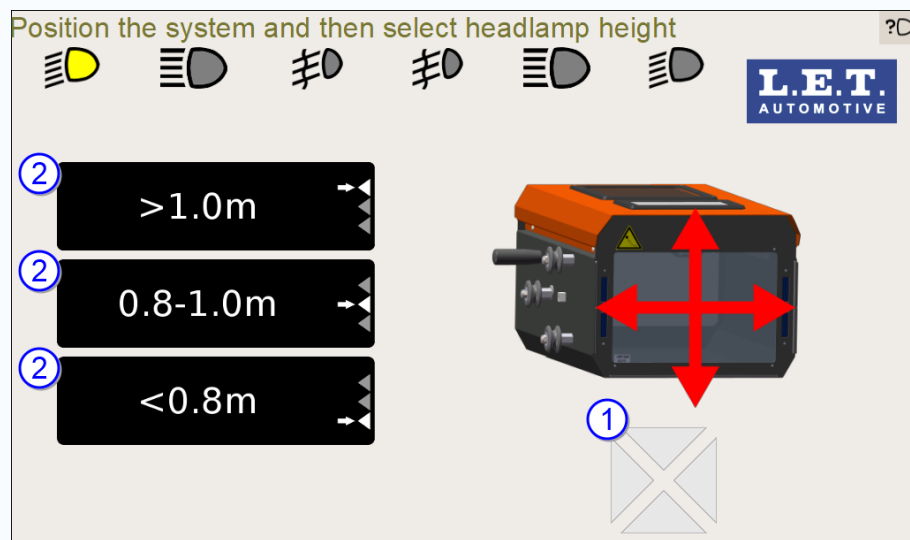

Figure 61: **Height selection** screen

1. Position the Luminoscope® in front of the headlamp by means of the electronic *Position Check* system 1. Once the optimal position is reached, all *Position Check Arrows* disappear (as shown on the image above).
2. Read the exact mounting height of the headlamp on the height sticker on the column by using the height indicator on the sliding table of the *Optical block*.
3. Tap on the corresponding **Height zone** buttons 2.

### Related tasks

[Positioning in front of the headlamp](#) (pg. 85)

### Related information

[Mounted height of the headlamp](#) (pg. 66)

## 7.2.8 Positioning in front of the headlamp

Before the headlamp measurement can start, it is required to position the Luminoscope® correctly in front of the headlamp by means of the electronic *Position Check* system.

**Attention:**

- A correct positioning of the Luminoscope® in front of the headlamp is necessary for an accurate headlamp measurement.
- The lens of the optical block may not be exposed to an interfering external light source (e.g. direct sunlight, light of other vehicles, etc.) which could cause incorrect positioning.



**Note:** As a result of the previous *Selection of mounted headlamp height* step, the optical block should already be correctly positioned in front of the headlamp.

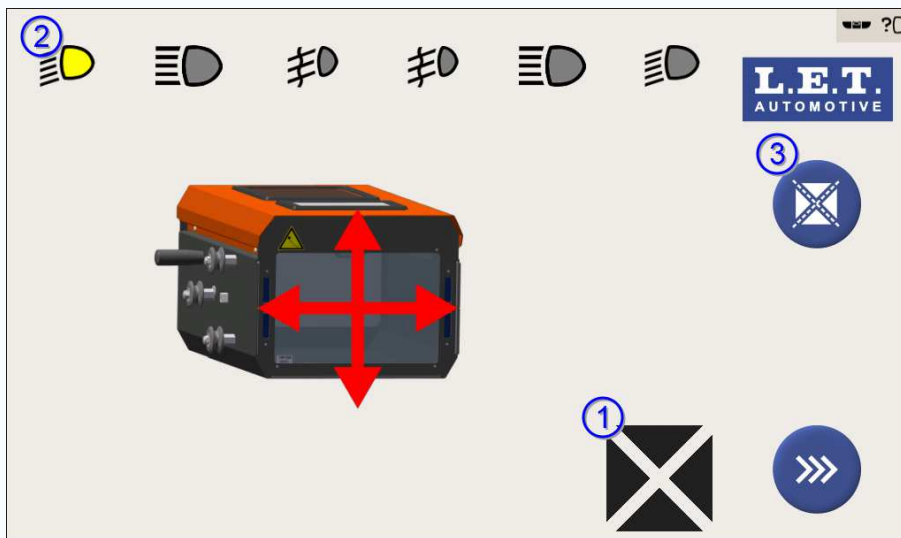

Figure 62: **Position Check** screen

1. Position the Luminoscope® in front of the headlamp under test 2 (the beam icon is displayed in yellow) by means of the black *Position Check Arrows* 1.
2. Move the optical block vertically and / or horizontally (without rotating the column) towards the direction of the arrows.

If the optimal position in front of the headlamp is achieved, the Luminoscope® automatically proceeds to the next phase in the test cycle.



**Attention:** In some situations it is not possible to reach an optimal position in front of the headlamp using the *Position Check*. This could be caused, for example, because of a very wide headlamp beam. In such a case, the alignment operation can be done manually.

3. Only in case of manual alignment operation: the operator positions the Luminoscope® in front of the headlamp by moving the optical block vertically and horizontally (without rotating the column) and by simultaneously looking at the beam projection on the white projection screen inside the optical block.
4. Once the beam projection looks as expected, tap on the **Skip Position Check** button 3.

**Related information**

[Positioning in front of the headlamp](#) (pg. 65)

**7.2.9 ESL (Electronic Spirit Level) module compensation**

The *ESL* (Electronic Spirit Level) module automatically takes into account the pitch and roll angles of the optical block to ensure an accurate headlamp measurement.

When not stable conditions are detected, the following screen is displayed.



Figure 63: *ESL* (Electronic Spirit Level) module screen

Wait until the *ESL* stabilizes.

As soon as the *ESL* is stabilised, the screen disappears and the actual headlamp measurement starts automatically. The angular measurement values of the *ESL* are taken automatically into account for the headlamp measurement.



**Note:** In case the Luminoscope® is (slightly) moved or shaken during the headlamp measurement, the *ESL* performs a new angular measurement and the above screen is displayed again. As soon as the *ESL* has been stabilized, the headlamp measurement resumes.

**Related information**

[ESL \(Electronic Spirit Level\) module](#) (pg. 74)

**7.2.10 Beam measurement**

The digital camera inside the Luminoscope® captures, processes and analyzes the headlamp beam projection.

The following sections explain the headlamp test procedure for a common and complete set of headlamps including:

- two ECE low beams,
- two high beams and
- two fog beams.

**Note:** The test sequence could look slightly different depending on the Luminoscope® configuration or selected program, which could be based on different regulations.

### Related information

[Headlamps \(pg. 21\)](#)

[Headlamp icons \(pg. 59\)](#)

#### 7.2.10.1 Low beam test

The next screen is displayed as soon as the first ECE low beam test starts.

**Note:** The screen is identical for the second low beam (except for the indication of the beam icons on top of the screen).

In case of an ECE LHD (Left Hand Drive) low beam:

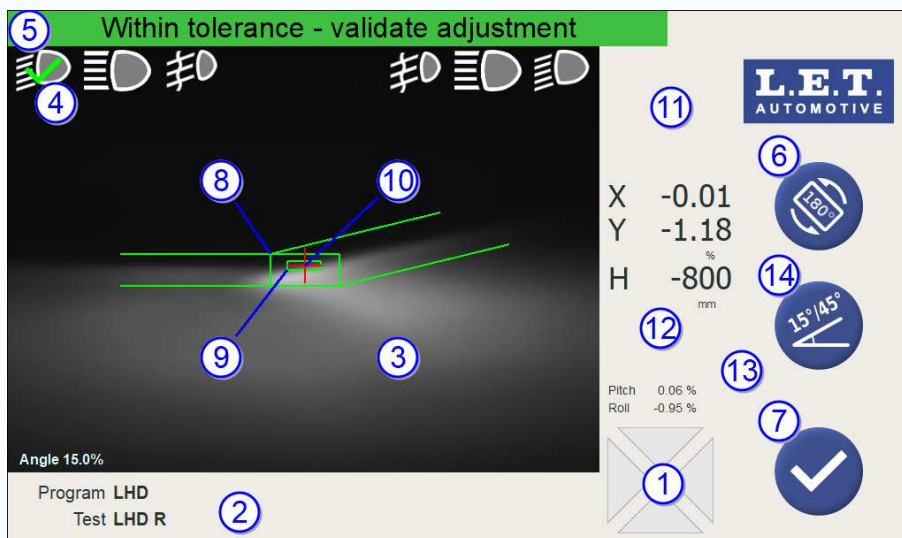

Figure 64: Example of an LHD low beam

In case of an ECE RHD (Right Hand Drive) low beam:

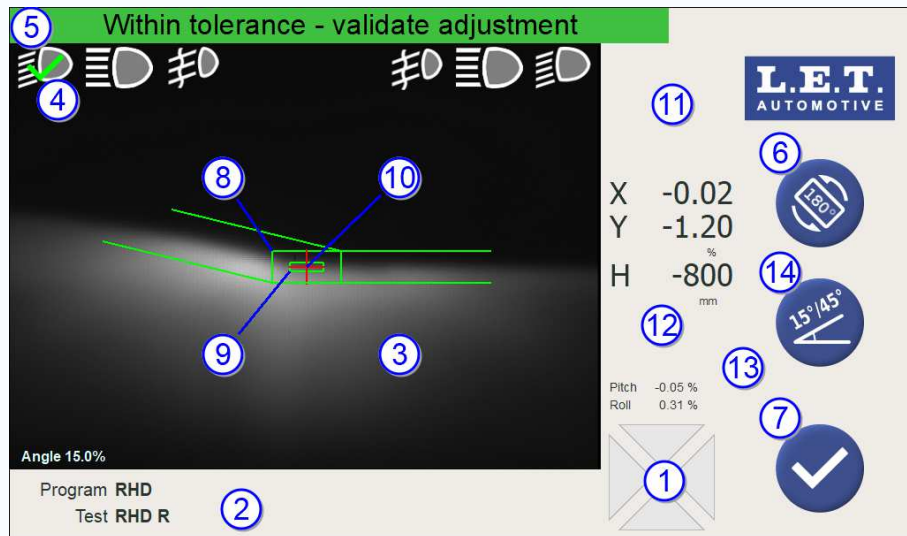

Figure 65: Example of an RHD low beam

#	Name	Description
1	<i>Position Check Arrows</i>	Indicates the direction(s) on which the optical block should be moved to achieve the optimal position in front of the headlamp. This position can change when adjusting the headlamp.
2	Information field	Depending on the Luminoscope® configuration, some related information such as the name of the selected program (Vehicle), the name of the test (Beam), license plate, etc. will be displayed.
3	Live headlamp beam image	Real time image of the headlamp beam including overlays for tolerance zone(s), algorithm measurement position, etc.
4	First low beam icon	First low beam icon indicating the status of the beam. The meaning of the icon depends on its shape and colour: <ul style="list-style-type: none"> <li>• <b>Yellow</b> mark means <i>Test in progress</i>.</li> <li>• <b>Green</b> V-sign means <i>Within tolerance</i>.</li> <li>• <b>Red</b> cross means <i>Out of tolerance</i>.</li> </ul>
5	Information banner	The information banner shows different status messages such as: <b>Test in progress</b> , <b>Within tolerance</b> , <b>Out of tolerance</b> , etc. Status, error or warning messages can also be displayed over there.
6	<b>Rotate screen</b> button	Rotate the screen position.
7	<b>Validation</b> button	If the <i>live validation</i> function is activated, tapping on this button will store the beam measurement result. The result is unconditionally stored whether the algorithm measurement position is <i>Within tolerance</i> or <i>Out of tolerance</i> .
8	Audit tolerance zone	The <i>audit tolerance zone</i> allows the operator to check if the headlamp is within the audit tolerances that are applicable in a government inspection station.
9	Aiming tolerance zone	The aiming tolerance zone allows the operator to adjust the headlamp correctly. Note that the aiming tolerance zone should always be smaller than the audit tolerance zone. This is to ensure that a correctly aimed headlamp at a workshop ( <i>using the smaller aiming tolerance zone</i> ) will pass the test in a government inspection station ( <i>using the larger audit tolerance zone</i> ).

#	Name	Description
10	Algorithm measurement position	The algorithm overlay (red cross) represents the algorithm measurement position on the headlamp beam image. In case of an aiming cycle, the red cross position should be aimed towards the centre of the aiming tolerance zone. In case of an audit cycle, the red cross position is evaluated. The actual position is displayed on the headlamp measurement result field.
11	Beam direction arrows	The beam direction arrows indicate the direction(s) in which the headlamp should be moved to reach the target position inside the tolerance zone.  The colour of the arrows indicates the live status of the aiming: <ul style="list-style-type: none"> <li>• <b>Green</b> means the result is <i>inside</i> the tolerance zone.</li> <li>• <b>Yellow</b> means the result is <i>close</i> to the tolerance zone.</li> <li>• <b>Red</b> means the result is <i>far away</i> from the tolerance zone.</li> </ul>
12	Headlamp measurement results field	Depending on the chosen algorithm and Luminoscope® configuration, headlamp measurement results such as horizontal beam position (X), vertical beam position (Y), etc. are displayed here.
13	ESL (Electronic Spirit Level) module angles	Measured Pitch and Roll angle of the ESL (Electronic Spirit Level) module, if applicable.
14	<b>Cut-off angle</b> button	Each time the <b>Cut-off angle</b> button is tapped, the selected angle of the low beam tolerance overlay changes between 15° and 45°. In most common cases the default selection of 15° can be used. Use the 45° selection only for ECE low beam <i>cut-off</i> lines with a 45° step. It is important to correctly set the angle because it has a direct consequence on the horizontal algorithm measurement position (determination of the <i>V-point</i> ) of the <i>cut-off</i> line.

**In case of an aiming cycle:**

1. Adjust the beam position until the algorithm measurement position (red cross) is inside the aiming tolerance zone.

**In case of an audit cycle:**

2. Check if the beam position is inside the *audit tolerance zone*.
3. If not, and if it is allowed to aim the headlamp on the spot, adjust the beam position inside the *aiming tolerance zone*.

**For both aiming and audit cycles:**

4. Tap on the **Validation** button 1 to store the beam measurement result.

The result is unconditionally stored whether the algorithm measurement position is *Within tolerance* or *Out of tolerance*.

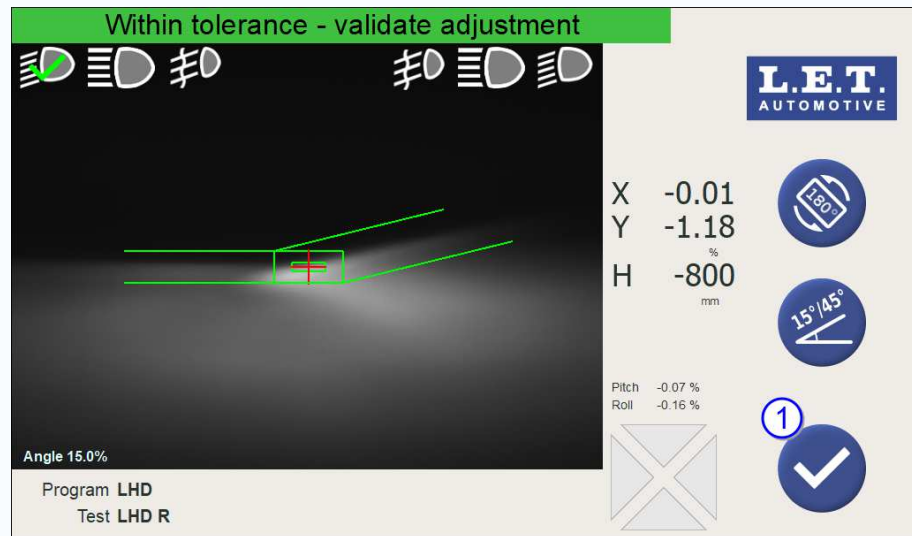

Figure 66: LHD low beam test screen

The **Beam selection** screen appears and the headlamp measurement results are displayed next to the corresponding beam icon 2.

**Note:** Depending on some Luminoscope® configuration parameters, the *headlamp intensity* may be automatically measured.

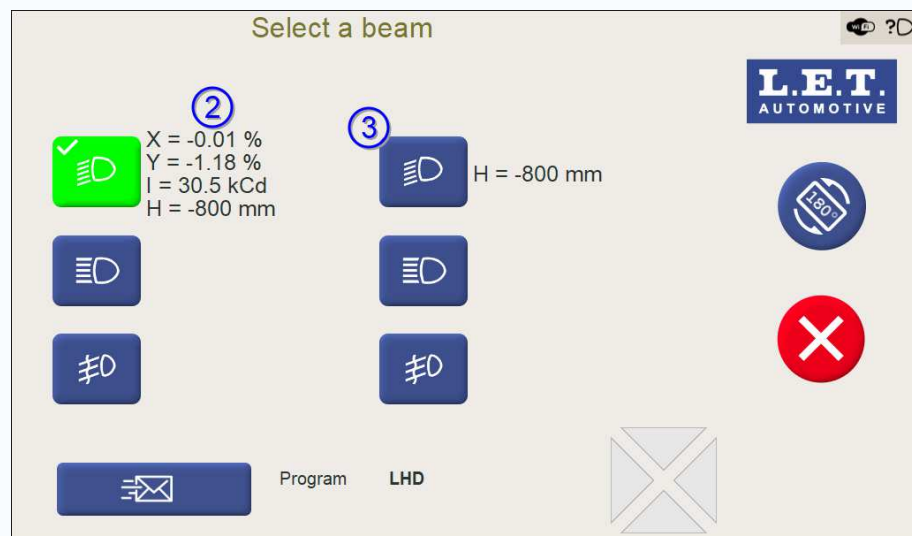

Figure 67: Low beam test results on **Beam selection** screen

**Eventually repeating the test on the same low beam:**

5. If required, repeat the test by tapping again on the corresponding beam selection button.

**Testing the second low beam:**

6. Move the Luminoscope® in front of the second low beam.
7. Tap on the **Second low beam** button on the **Beam selection** screen 3.



**Note:** The height selection should only be done before the first low beam measurement in the cycle. The selected height zone is copied automatically for the second low beam.

**8.** Repeat the step *Positioning in front of the headlamp*.

Make sure the optical block is correctly positioned in front of the second low beam.

### Related tasks

[Positioning in front of the headlamp](#) (pg. 85)

### 7.2.10.2 High beam test

The next screen is displayed as soon as the first high beam test starts.



**Note:** The screen is identical for the second high beam (except for the indication of the beam icons on top of the screen).

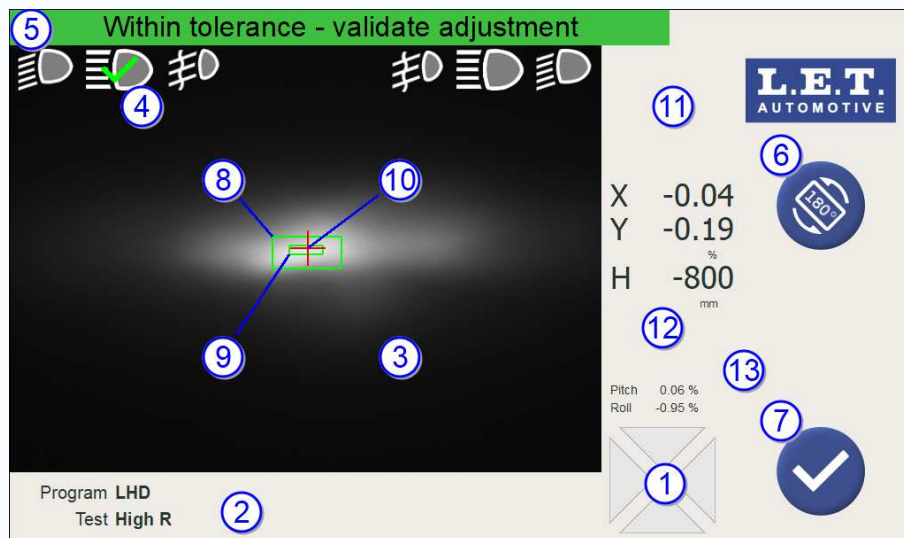

Figure 68: Example of a high beam

#	Name	Description
1	<i>Position Check Arrows</i>	Indicates the direction(s) on which the optical block should be moved to achieve the optimal position in front of the headlamp. This position can change when adjusting the headlamp.
2	Information field	Depending on the Luminoscope® configuration, some related information such as the name of the selected program (Vehicle), the name of the test (Beam), license plate, etc. will be displayed.
3	Live headlamp beam image	Real time image of the headlamp beam including overlays for tolerance zone(s), algorithm measurement position, etc.

#	Name	Description
4	First high beam icon	<p>First high beam icon indicating the status of the beam.</p> <p>The meaning of the icon depends on its shape and colour:</p> <ul style="list-style-type: none"> <li>• <b>Yellow</b> mark means <i>Test in progress</i>.</li> <li>• <b>Green</b> V-sign means <i>Within tolerance</i>.</li> <li>• <b>Red</b> cross means <i>Out of tolerance</i>.</li> </ul>
5	Information banner	The information banner shows different status messages such as: <b>Test in progress</b> , <b>Within tolerance</b> , <b>Out of tolerance</b> , etc. Status, error or warning messages can also be displayed over there.
6	<b>Rotate screen</b> button	Rotate the screen position.
7	<b>Validation</b> button	If the <i>live validation</i> function is activated, tapping on this button will store the beam measurement result. The result is unconditionally stored whether the algorithm measurement position is <i>Within tolerance</i> or <i>Out of tolerance</i> .
8	Audit tolerance zone	The <i>audit tolerance zone</i> allows the operator to check if the headlamp is within the audit tolerances that are applicable in a government inspection station.
9	Aiming tolerance zone	The aiming tolerance zone allows the operator to adjust the headlamp correctly. Note that the aiming tolerance zone should always be smaller than the audit tolerance zone. This is to ensure that a correctly aimed headlamp at a workshop ( <i>using the smaller aiming tolerance zone</i> ) will pass the test in a government inspection station ( <i>using the larger audit tolerance zone</i> ).
10	Algorithm measurement position	The algorithm overlay (red cross) represents the algorithm measurement position on the headlamp beam image. In case of an aiming cycle, the red cross position should be aimed towards the centre of the aiming tolerance zone. In case of an audit cycle, the red cross position is evaluated. The actual position is displayed on the headlamp measurement result field.
11	Beam direction arrows	<p>The beam direction arrows indicate the direction(s) in which the headlamp should be moved to reach the target position inside the tolerance zone.</p> <p>The colour of the arrows indicates the live status of the aiming:</p> <ul style="list-style-type: none"> <li>• <b>Green</b> means the result is <i>inside</i> the tolerance zone.</li> <li>• <b>Yellow</b> means the result is <i>close</i> to the tolerance zone.</li> <li>• <b>Red</b> means the result is <i>far away</i> from the tolerance zone.</li> </ul>
12	Headlamp measurement results field	Depending on the chosen algorithm and Luminoscope® configuration, headlamp measurement results such as horizontal beam position (X), vertical beam position (Y), etc. are displayed here.
13	ESL (Electronic Spirit Level) module angles	Measured Pitch and Roll angle of the ESL (Electronic Spirit Level) module, if applicable.

**In case of an aiming cycle:**

1. Adjust the beam position until the algorithm measurement position (red cross) is inside the aiming tolerance zone.

**In case of an audit cycle:**

2. Check if the beam position is inside the *audit tolerance zone*.
3. If not, and if it is allowed to aim the headlamp on the spot, adjust the beam position inside the *aiming tolerance zone*.

**For both aiming and audit cycles:**

4. Tap on the **Validation** button 1 to store the beam measurement result.

The result is unconditionally stored whether the algorithm measurement position is *Within tolerance* or *Out of tolerance*.

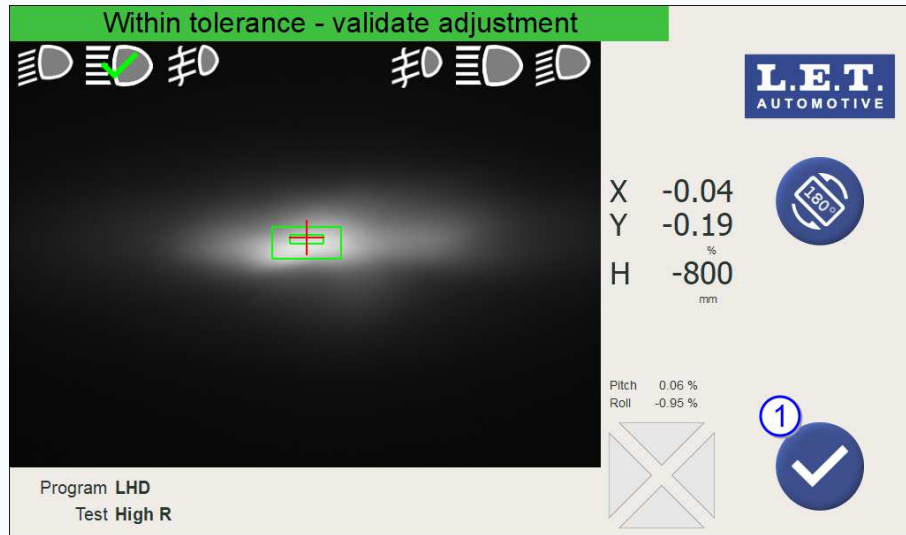

Figure 69: High beam test screen

The **Beam selection** screen appears and the headlamp measurement results are displayed next to the corresponding beam icon 2.

**Note:** Depending on some Luminoscope® configuration parameters, the *headlamp intensity* may be automatically measured.

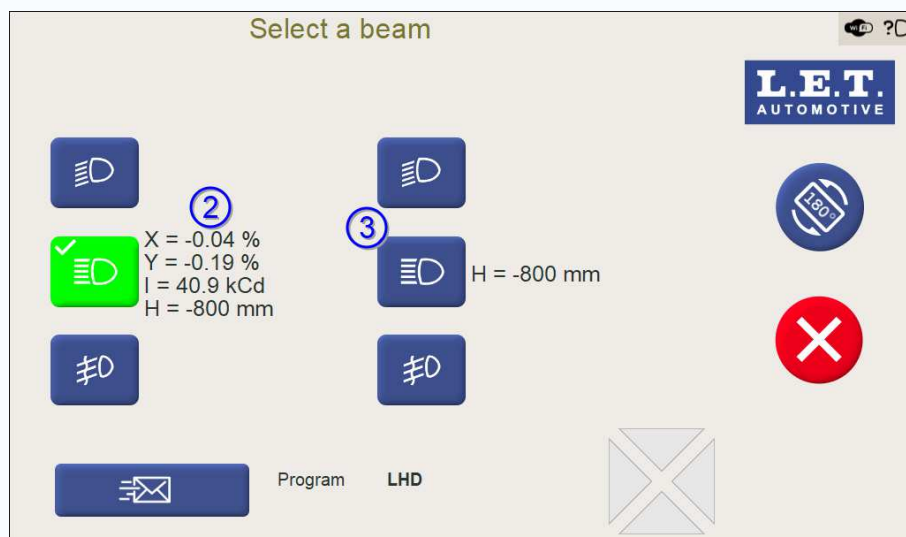

Figure 70: High beam test results on **Beam selection** screen

**Eventually repeating the test on the same high beam:**

5. If required, repeat the test by tapping again on the corresponding beam selection button.

**Testing the second high beam:**

6. Move the Luminoscope® in front of the second high beam.

7. Tap on the **Second high beam** button on the **Beam selection** screen 3.



**Note:** The height selection should only be done before the first high beam measurement in the cycle. The selected height zone is copied automatically for the second high beam.

8. Repeat the step *Positioning in front of the headlamp*.

Make sure the optical block is correctly positioned in front of the second high beam.

**Related tasks**

[Positioning in front of the headlamp](#) (pg. 85)

**7.2.10.3 Fog beam test**

The next screen is displayed as soon as the first fog beam test starts.



**Note:** The screen is identical for the second fog beam (except the indication of the beam icons on top of the screen).

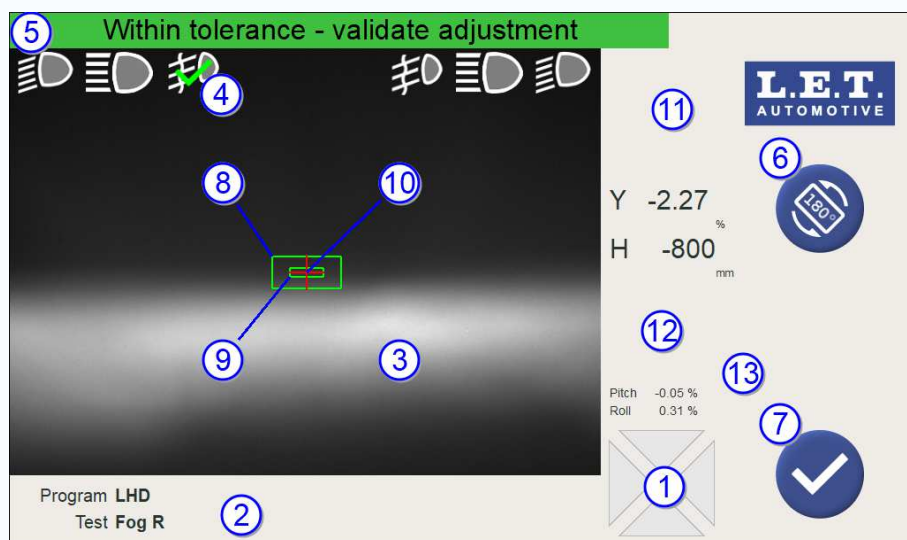

Figure 71: Example of a fog beam

**In case of an aiming cycle:**

1. Adjust the beam position until the algorithm measurement position (red cross) is inside the aiming tolerance zone.

**In case of an *audit cycle*:**

2. Check if the beam position is inside the *audit tolerance zone*.
3. If not, and if it is allowed to aim the headlamp on the spot, adjust the beam position inside the *aiming tolerance zone*.

**For both aiming and audit cycles:**

4. Tap on the **Validation** button 1 to store the beam measurement result.

The result is unconditionally stored whether the algorithm measurement position is *Within tolerance* or *Out of tolerance*.

The **Beam selection** screen appears and the headlamp measurement results are displayed next to the corresponding beam icon 2.



**Note:** Depending on some Luminoscope® configuration parameters, the *headlamp intensity* may be automatically measured.

**Eventually repeating the test on the same fog beam:**

5. If required, repeat the test by tapping again on the corresponding beam selection button.

**Testing the second fog beam:**

**Related tasks**

[Positioning in front of the headlamp](#) (pg. 85)

## 7.2.11 Beam measurement results

When all tests are completed, the **Beam selection** screen displays all beam measurement results.

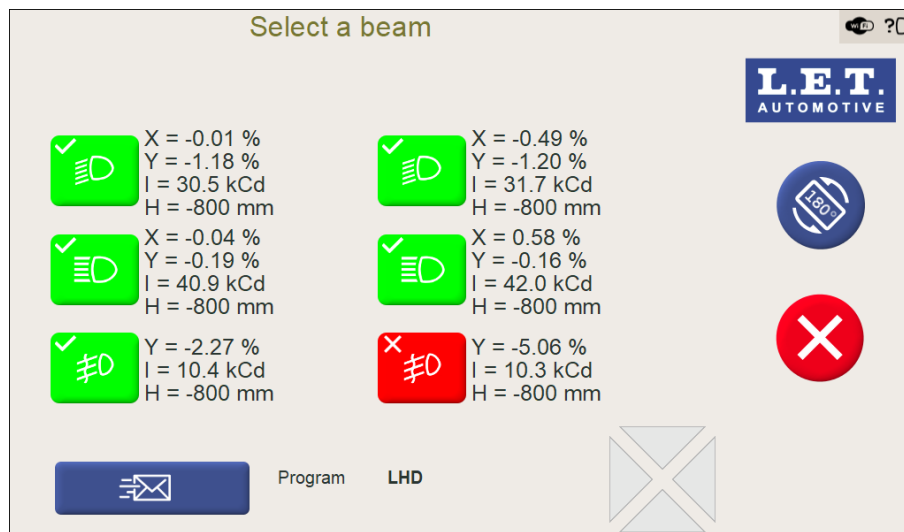



Figure 72: Overview of beam measurement results

 **Note:** If required, each test can be repeated by tapping on the corresponding beam selection button again.

### 7.2.12 Test cycle reports and data transmission

Depending on the configuration of the Luminoscope®, the measurement results can be stored on the system (PDF format), printed on a paper ticket or transmitted to an external device using one of the communication protocols.

1. Tap on the **Send results** button 1.

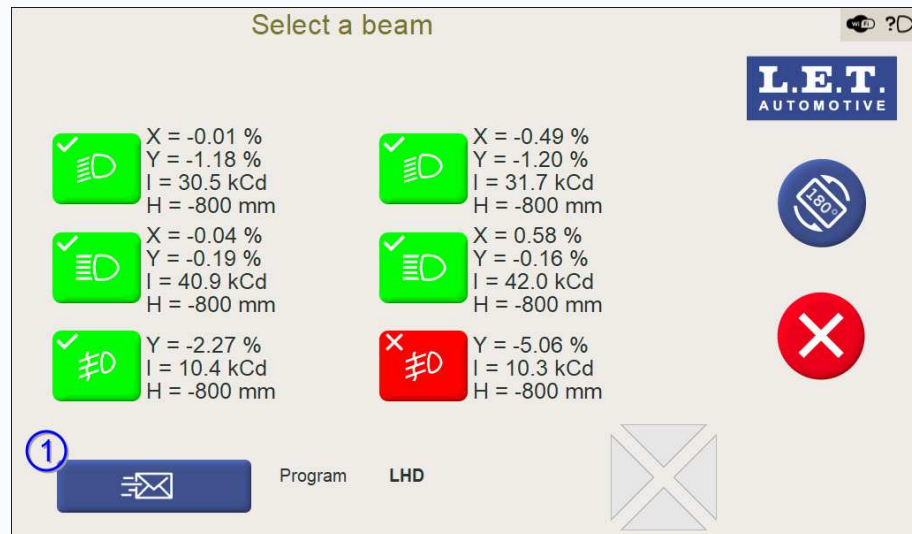

Figure 73: **Send results** button on **Beam selection** screen

2. Enter the *license plate number* of the vehicle (or leave it empty if not required) and tap on the **Validation** button 2. The license plate entered becomes part of the file name of the produced file.

Alternatively, tap on the **Abort** button 3 to cancel the operation.

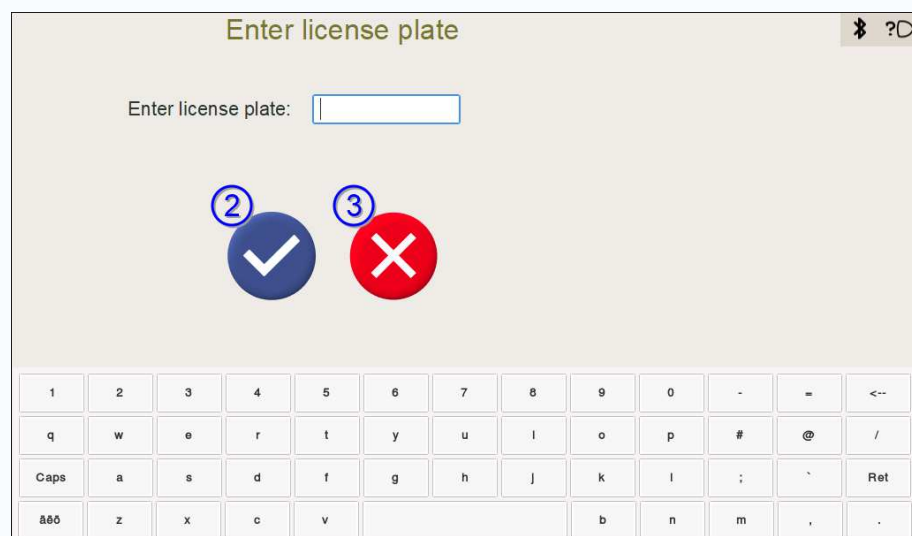

Figure 74: **License plate input** screen

In case the Luminoscope® is configured to store the results on the system (PDF format), the file is now created.

In case the Luminoscope® is configured to use a ticket printer, the ticket is now printed.



The **Program selection** screen will be displayed again. The Luminoscope® is ready to start a new test cycle.

### 7.2.12.1 Test report as a PDF file

In the case the Luminoscope® is configured to store the measurement results on the system (PDF format), the generated reports can be exported afterwards to a USB stick via the Export functionality. The reports can also be downloaded via the web interface.



**Note:** The report layout depends on the Luminoscope® configuration and on the selected program, and consequently the format of the report below may differ.

	Vaartlaan 20 B-9800 Deinze Tel : +32 9 381 87 87 Website : www.let.be Email : info@let.be		
---	---	---	--

Brand: LUMINOSCOPE  
 Model: SLA 40  
 Serial N°: EP240010.123  
 Software version: xx.xx.xx LM40\_XXXX  
 Date, Time: 25/02/2024 11:19:34  
 Program: LHD  
 License plate: 1-LET-123

Low beam height: < 0,8m

	L/R [%]	U/D [%]	STATUS	I [kCd]
Low Left:	-0,49 %	-1,20 %	OK	31,7 kCd
Low Right:	-0,01 %	-1,18 %	OK	30,5 kCd

High beam height: < 0,8m

	L/R [%]	U/D [%]	STATUS	I [kCd]
High Left:	0,58 %	-0,16 %	OK	42,0 kCd
High Right:	-0,04 %	-0,19 %	OK	40,9 kCd

Fog beam height: < 0,8m

	L/R [%]	U/D [%]	STATUS	I [kCd]
Fog Left:	-	-5,06 %	NOK	10,3 kCd
Fog Right:	-	-2,27 %	OK	10,4 kCd

Result: OK

1/1

Figure 75: Example of a test report

Parameter	Description
Brand	Luminoscope®.
Model	Model of Luminoscope®.
Serial number	Serial number of the Luminoscope® optical block.
Software version	Software version of the Luminoscope®.
Date, time	Date and time of the test.
Program	Selected program.
License plate	License plate number of the vehicle.
Low beam height	Selected mounting height zone of the low beams.
Low Left	Measurement results of the left low beam in the specified units: Horizontal beam position (L/R), vertical beam position (U/D), Status (OK or NOK) and intensity (I).
Low Right	Measurement results of the right low beam in the specified units: Horizontal beam position (L/R), vertical beam position (U/D), Status (OK or NOK) and intensity (I).
High beam height	Selected mounting height zone of the high beams.
High Left	Measurement results of the left high beam in the specified units: Horizontal beam position (L/R), vertical beam position (U/D), Status (OK or NOK) and intensity (I).
High Right	Measurement results of the right high beam in the specified units: Horizontal beam position (L/R), vertical beam position (U/D), Status (OK or NOK) and intensity (I).
Fog beam height	Selected mounting height zone of the fog beams.
Fog Left	Measurement results of the left fog beam in the specified units: Horizontal beam position (L/R), vertical beam position (U/D), Status (OK or NOK) and intensity (I).
Fog Right	Measurement results of the right fog beam in the specified units: Horizontal beam position (L/R), vertical beam position (U/D), Status (OK or NOK) and intensity (I).

### Related tasks

[Exporting test results to a USB stick \(pg. 204\)](#)

[Check and/or print the PDF test reports \(pg. 245\)](#)

### 7.2.12.2 Test report as printed ticket

Depending on the configuration of the Luminoscope®, the measurement results can be printed on a ticket printer.

This ticket printer may be connected to the Luminoscope® either via a serial line or over a *Bluetooth* link.



**Note:** The ticket layout depends on the Luminoscope® configuration and on the selected program, and consequently the format of the ticket below may differ.

```

Customer: xxxxxxxx

Type: Luminoscope SLA 40

Serial number: EP240010.123

Date, time: 11/03/2024 08: 11: 37

Program: LHD

License plate: 1-LET-123

-----
Results: L/R(%): U/D(%): Status: I(kCd)

Low beam height: -800mm
LOW L:  -0,49; -1,20; P; 31,7
LOW R:  -0,01 -1,18; P; 30,5
High beam height: -800mm
HIGH L:  0,58; -0,16; P; 42,0
HIGH R: -0,04; -0,19; P; 40,9
Fog beam height: -800mm
FOG L:   0,00; -5,06; F; 10,3
FOG R:   0,00; -2,27; P; 10,4

```

Figure 76: Example of measurement results on ticket

Parameter	Description
Customer	Customer name.
Type	Model of Luminoscope®.
Serial number	Serial number of the Luminoscope® optical block.
Date, time	Date and time of the test.
Program	Selected program.
License plate	License plate number of the vehicle.
Results	<p>Arranged in columns with the following structure:</p> <ul style="list-style-type: none"> <li>• <b>L/R</b>: (Left/Right) horizontal beam position, expressed in the specified units.</li> <li>• <b>U/D</b>: (Up/Down) vertical beam position, expressed in the specified units.</li> <li>• <b>Status</b>: summarized result of the test, can be either <b>P</b> (Passed), or <b>F</b> (Failed).</li> <li>• <b>I</b>: (Intensity), expressed in kCd.</li> </ul>
Low beam height	Specified mounting height zone of the low beams.
Low L	Measurement results of the left low beam in the specified units.
Low R	Measurement results of the right low beam in the specified units.
High beam height	Specified mounting height zone of the high beams.
High L	Measurement results of the left high beam in the specified units.
High R	Measurement results of the right high beam in the specified units.
Fog beam height	Specified mounting height zone of the fog beams.
Fog L	Measurement results of the left fog beam in the specified units.
Fog R	Measurement results of the right fog beam in the specified units.

### 7.2.12.3 Test results transfer to the host computer (communication protocols)

Depending on the configuration of the Luminoscope®, the test results can be transferred to a host computer by means of a specific communication protocol.

In addition, the program selection can also be remotely initiated by a host computer, to start a test cycle by means of a specific communication protocol.

Finally, there are some other communication protocols available for customer specific purposes.



#### Note:

- Depending on the customer specific implementation and configuration, the communication can be done via an RS232 serial line connection, wired *Ethernet* connection, *WiFi* connection or *Bluetooth* connection.
- The protocol descriptions are available on request.

Depending on their purpose, the communication protocols can be categorised in different groups.

#### Communication between the Luminoscope® and a host computer

Protocol group	Description
Lamp data protocols	A telegram is issued by the Luminoscope® at the end of each beam measurement and acknowledged by the host computer.  It includes, among other data, the headlamp beam characteristics of a single headlamp (e.g. horizontal beam position, vertical beam position, beam intensity...).
Vehicle data protocols	A telegram is issued by the Luminoscope® at the end of each test cycle and acknowledged by the host computer.  It includes, among other data, the headlamp beam characteristics of all tested headlamps (e.g. horizontal beam position, vertical beam position, beam intensity...).
Program selection protocols	A telegram is issued by the host computer at the start of the test cycle and acknowledged by the Luminoscope®.  It includes, among other data, the <i>VSN</i> (Vehicle Selection Number) for choosing one of the selectable programs on the program selection screen and starting the corresponding test cycle.
Info telegrams protocols	A telegram is issued by the Luminoscope® at specific moments during the test cycle.  Data includes, among other information, status of the Luminoscope® system (e.g. system reaches <i>park position</i> at the end of the cycle, system starts the zeroing procedure, cycle was finished, system error appeared...).

## 7.3 OEM test cycle sequences

The **OEM** button on the **Program selection** screen with different test mode selection buttons provides access to some special *Original Equipment Manufacturer* sequences for various beam types.

**Note:** In case the **Program selection** screen is a list with different selectable test modes, there is no **OEM** button available. However, this chapter can be used as a reference for understanding the different possibilities of the Luminoscope® system.

1. Tap on the **OEM** button 1 on the **Program selection** screen.

**Note:** The screen may have a different appearance depending on the customer's specific implementation.

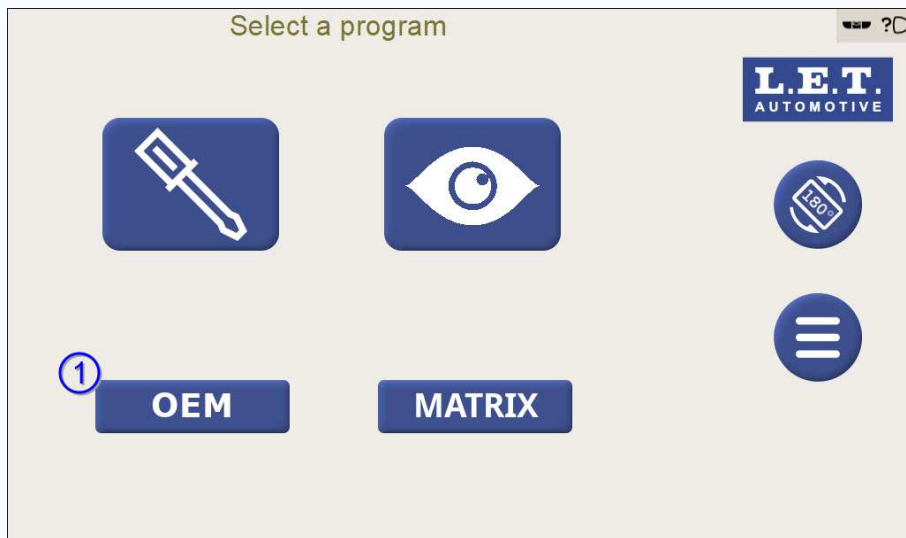

Figure 77: **Program selection** screen with **OEM** button

The **OEM program selection** screen is now displayed.

2. Select one of the options on the **OEM program selection** screen by tapping on the corresponding button.

**Note:** The screen may have a different appearance depending on the customer's specific implementation.

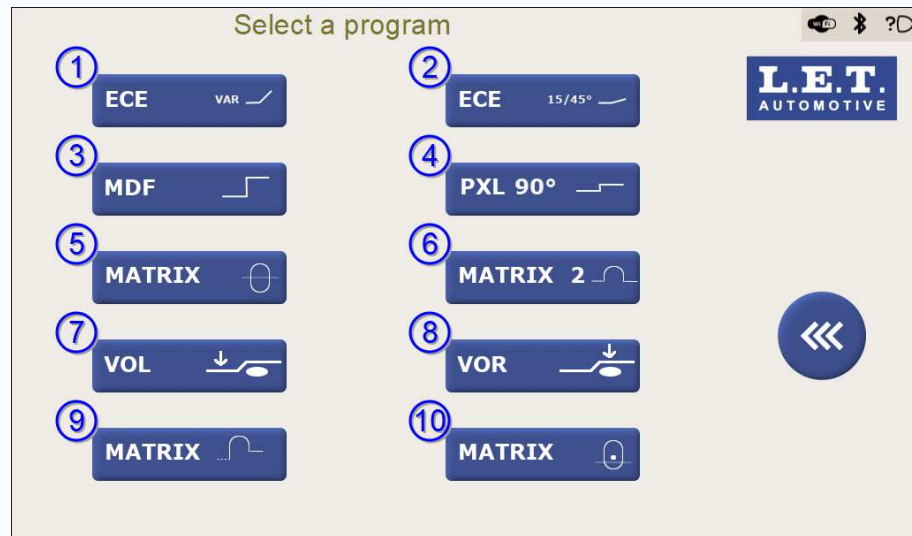





Figure 78: OEM program selection screen

#	Button	Description
1	<b>ECE-VAR</b> button	Program selection for <i>ECE</i> low beam adjustment with <i>automatic calculation of the angle</i> of the cut-off line ( <b>ECE – variable angle</b> ).
2	<b>ECE-15/45</b> button	Program selection for <i>ECE</i> low beam adjustment with <i>manual determination of the angle</i> of the cut-off line ( <b>ECE – 15° or 45° angle</b> ).
3	<b>MDF</b> button	Program selection for <i>MDF (Maskiertes Dauerfernlicht)</i> high beam adjustment. An <i>MDF</i> high beam, is a glare free high beam with beam motorisation
4	<b>PXL 90°</b> button	Program selection for <i>PIXEL 90 (PXL 90)</i> low beam adjustment. A <i>PIXEL 90</i> low beam headlamp, is a low beam where the known <i>ECE – 15° or 45° angle</i> is replaced by a 90° angle. They are also called <i>IQ-light</i> .
5	<b>VW/Audi Matrix</b> button	Program selection for <i>Matrix</i> high beam calibration. A <i>Matrix</i> high beam, is a glare free high beam with multiple <i>LED</i> sources.  <div style="text-align: right;">  <b>Note:</b> This specific <i>Matrix</i> selection is only applicable to vehicles of the <i>VW-Audi</i> group which feature <i>Matrix</i> beams. </div>

#	Button	Description
6	<b>VW/Audi Matrix 2.0</b> button	<p>Program selection for <i>Matrix 2.0</i> high beam calibration. A <i>Matrix 2.0</i> high beam, is a glare free high beam with multiple <i>LED</i> sources.</p> <p> <b>Note:</b> This specific <i>Matrix 2.0</i> selection is only applicable to vehicles of the <i>VW-Audi</i> group which feature <i>Matrix 2.0</i> beams.</p>
7	<b>VOL</b> button	<p>Program selection for <i>SAE VOL</i> low beam adjustment. This selection could be used to adjust <i>American VOL</i> low beams to be used in the Belgian traffic.</p>
8	<b>VOR</b> button	<p>Program selection for <i>SAE VOR</i> low beam adjustment. This selection could be used to adjust <i>American VOR</i> low beams to be used in the Belgian traffic.</p>
9	<b>Skoda Matrix</b> button	<p>Program selection for <i>Matrix</i> high beam calibration. A <i>Matrix</i> high beam, is a glare free high beam with multiple <i>LED</i> sources.</p> <p> <b>Note:</b> This specific <i>Matrix</i> selection is only applicable to vehicles of the <i>Skoda</i> group (in particular the <i>Skoda Octavia</i>) which feature <i>Matrix</i> beams.</p>
10	<b>Renault Matrix</b> button	<p>Program selection for <i>Matrix</i> high beam calibration. A <i>Matrix</i> high beam, is a glare free high beam with multiple <i>LED</i> sources.</p> <p> <b>Note:</b> This specific <i>Matrix</i> selection is only applicable to vehicles of the <i>Renault</i> group which feature <i>Matrix</i> beams.</p>

### Related tasks

- [ECE-VAR low beam sequence \(pg. 105\)](#)
- [ECE - 15°/45° low beam sequence \(pg. 110\)](#)
- [MDF high beam sequence \(pg. 116\)](#)
- [PIXEL 90 low beam sequence \(pg. 122\)](#)
- [VW/AUDI Matrix high beam sequence \(pg. 130\)](#)
- [VW/AUDI Matrix 2.0 high beam sequence \(pg. 138\)](#)
- [SKODA Matrix high beam sequence \(pg. 147\)](#)
- [Renault Matrix high beam sequence \(pg. 162\)](#)
- [VOL American low beam sequence \(pg. 168\)](#)
- [VOR American low beam sequence \(pg. 173\)](#)

### 7.3.1 ECE-VAR low beam sequence

This chapter explains the use of the OEM program selection for the adjustment of ECE low beams with *automatic calculation* of the angle of the *cut-off line* (**ECE – variable angle**).

**Note:** The ECE-VAR program could be used for low beams with a angle in a range of 10° till 50°. However, in most common cases the ECE-15/45 program should be used instead of the ECE-VAR program.

Tap on the **ECE-VAR** button 1 on the **OEM program selection** screen.

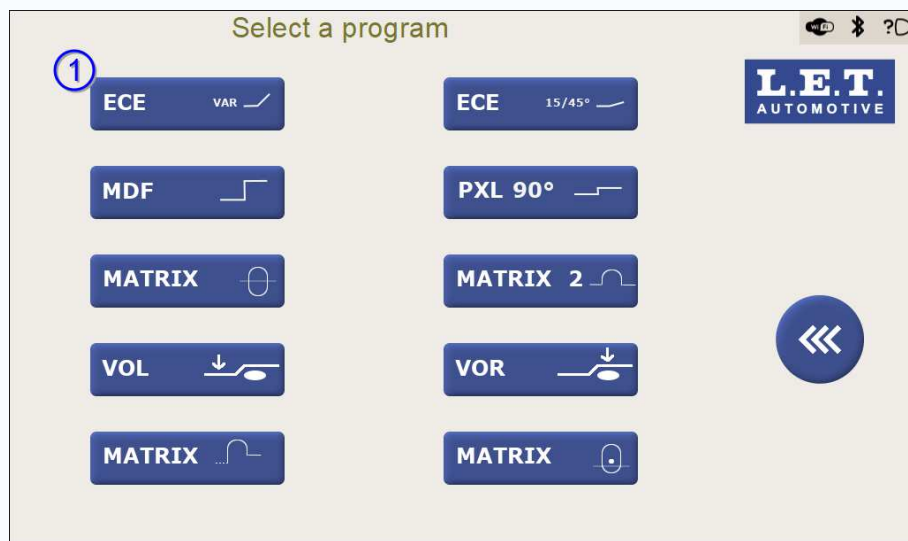

Figure 79: OEM program selection screen with ECE-VAR button

The **Beam selection** screen for the ECE-VAR program is now displayed.

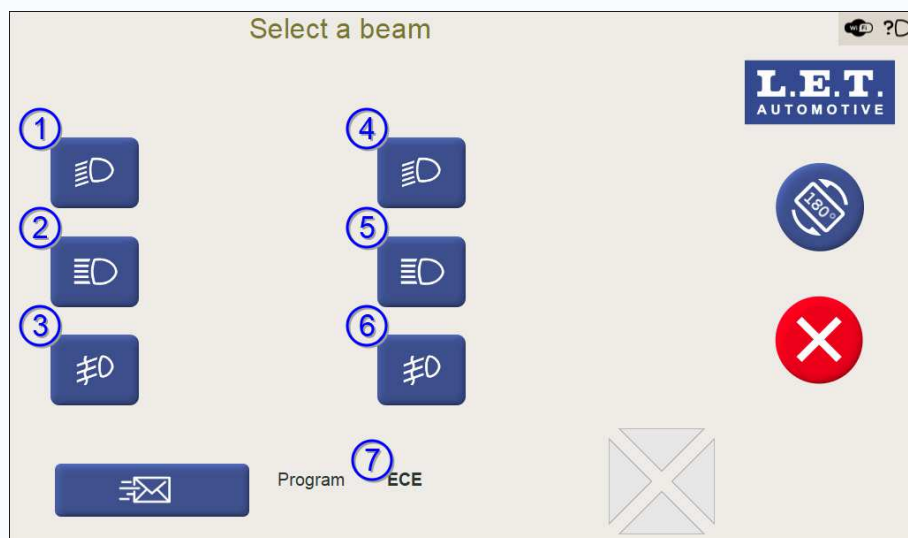

Figure 80: Beam selection screen for ECE-VAR program

#	Button	Description
1	First ECE low beam	Starts the test of the first ECE low beam.

#	Button	Description
2	First high beam	Starts the test of the first high beam.
3	First fog beam	Starts the test of the first fog beam.
4	Second ECE low beam	Starts the test of the second ECE low beam.
5	Second high beam	Starts the test of the second high beam.
6	Second fog beam	Starts the test of the second fog beam.
7	Program name	<i>ECE program.</i>



**Note:** Rotating the screen position affects to the position of the beam icons and beam selection buttons on the screen. The intelligence of the Luminoscope® automatically places the beam icons and beam selection buttons on the correct side of the vehicle. For both screen orientation modes, the beam icons and beam selection buttons which are closer to the left side of the vehicle are applicable for the headlamps on the left side. Those closer to the right side of the vehicle are applicable for the headlamps on the right side.

### Related information

[ECE or European low beam](#) (pg. 21)

[Left / right vehicle side definition](#) (pg. 61)

#### 7.3.1.1 Summary of the test sequence

What follows is a summarized listing of the steps for the test sequence. Refer to the next chapter for a detailed explanation of each step.

1. Align the Luminoscope® with the vehicle.
2. Tap on the beam selection button corresponding with the left or right *ECE* low beam.
3. Position the Luminoscope® sequentially in front of both *ECE* low beams.
4. Adjust both *ECE* low beams sequentially.

#### 7.3.1.2 Test sequence

1. Align the Luminoscope® with the vehicle.

Before the start of the actual test, the Luminoscope® should be properly aligned with the longitudinal axis (driving direction) of the vehicle. This is crucial in order to minimize the measurement result error in the horizontal direction. At the end of the chapter there is a link with related information on how to align the Luminoscope®.

**The next three steps are to be applied to both *ECE* low beams sequentially.**

2. Tap on the beam selection button corresponding with the left or right *ECE* low beam on the **Beam selection** screen to start its calibration.

**Note:** Rotating the screen position affects to the position of the beam icons and beam selection buttons on the screen. The intelligence of the Luminoscope® automatically places the beam icons and beam selection buttons on the correct side of the vehicle. For both screen orientation modes, the beam icons and beam selection buttons which are closer to the left side of the vehicle are applicable for the headlamps on the left side. Those closer to the right side of the vehicle are applicable for the headlamps on the right side.

**3.** Position the Luminoscope® in front of the selected ECE low beam.

Make use of the electronic *Position Check* system.

Once the optimal position in front of the headlamp is achieved, the Luminoscope® proceeds automatically to the next phase in the test.

**4.** Adjust the selected ECE low beam.

Both ECE low beams should be adjusted with exactly the same procedure.

**Note:** The ECE low beam algorithm is capable to determine the horizontal and vertical position of the *V-point* (also called *elbow point* or *kink point*) of the *cut-off line*. With this ECE-VAR program, the ECE low beam algorithm is also capable to determine the angle of the ECE low beam *cut-off line*.

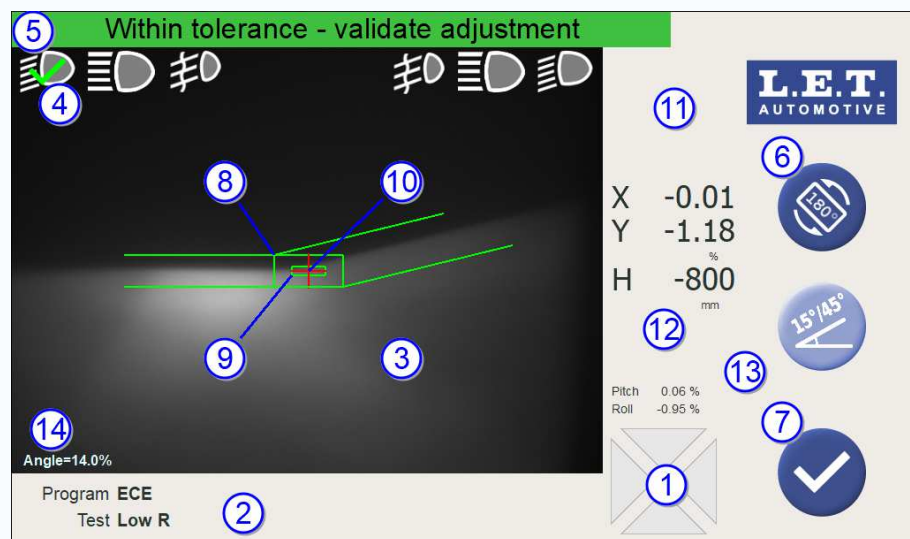

Figure 81: Right ECE low beam adjustment

#	Name	Description
1	<i>Position Check Arrows</i>	Indicates the direction(s) on which the optical block should be moved to achieve the optimal position in front of the headlamp. This position can change when adjusting the headlamp.

#	Name	Description
2	Information field	Depending on the Luminoscope® configuration, some related information such as the name of the selected program (Vehicle), the name of the test (Beam), license plate, etc. will be displayed.
3	Live headlamp beam image	Real time image of the headlamp beam including overlays for tolerance zone(s), algorithm measurement position, etc.
4	Low beam icon	Low beam icon indicating the status of the beam. The meaning of the icon depends on its shape and color: <ul style="list-style-type: none"> <li>• <b>Yellow</b> mark means <b>Test in progress</b>.</li> <li>• <b>Green</b> V-sign means <b>In tolerance</b>.</li> <li>• <b>Red</b> cross means <b>Out of tolerance</b>.</li> </ul>
5	Information banner	The information banner shows different status messages such as: <b>Test in progress</b> , <b>Within tolerance</b> , <b>Out of tolerance</b> , etc. Status, error or warning messages can also be displayed over there.
6	<b>Rotate screen</b> button	Rotate the screen position.
7	<b>Validation</b> button	If the <i>live validation</i> function is activated, tapping on this button will store the beam measurement result. The result is unconditionally stored whether the algorithm measurement position is <i>Within tolerance</i> or <i>Out of tolerance</i> .
8	Audit tolerance zone	The <i>audit tolerance zone</i> allows the operator to check if the headlamp is within the audit tolerances that are applicable in a government inspection station.
9	Aiming tolerance zone	The aiming tolerance zone allows the operator to adjust the headlamp correctly. Note that the aiming tolerance zone should always be smaller than the audit tolerance zone. This is to ensure that a correctly aimed headlamp at a workshop ( <i>using the smaller aiming tolerance zone</i> ) will pass the test in a government inspection station ( <i>using the larger audit tolerance zone</i> ).
10	Algorithm measurement position	The algorithm overlay (red cross) represents the algorithm measurement position on the headlamp beam image. In case of an aiming cycle, the red cross position should be aimed towards the centre of the aiming tolerance zone. In case of an audit cycle, the red cross position is evaluated. The actual position is displayed on the headlamp measurement result field.

#	Name	Description
11	Beam direction arrows	<p>The beam direction arrows indicate the direction(s) in which the headlamp should be moved to reach the target position inside the tolerance zone.</p> <p>The colour of the arrows indicates the live status of the aiming:</p> <ul style="list-style-type: none"> <li>• <b>Green</b> means the result is <i>inside</i> the tolerance zone.</li> <li>• <b>Yellow</b> means the result is <i>close</i> to the tolerance zone.</li> <li>• <b>Red</b> means the result is <i>far away</i> from the tolerance zone.</li> </ul>
12	Headlamp measurement results field	Depending on the chosen algorithm and Luminoscope® configuration, headlamp measurement results such as horizontal beam position (X), vertical beam position (Y), etc. are displayed here.
13	ESL (Electronic Spirit Level) module angles	Measured Pitch and Roll angle of the ESL (Electronic Spirit Level) module, if applicable.
14	Cut-off angle field	The angle of the ECE low beam cut-off line is displayed here.

The following **Beam selection** screen is shown when both ECE low beams are properly adjusted.

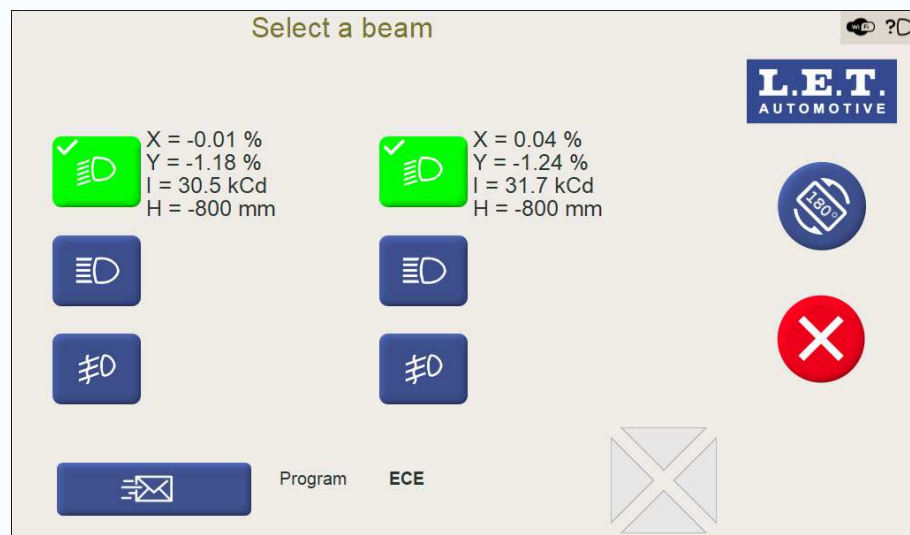

Figure 82: **Beam selection** screen with ECE low beam test results



**Note:** Rotating the screen position affects to the position of the beam icons and beam selection buttons on the screen. The intelligence of the Luminoscope® automatically places the beam icons and beam selection buttons on the correct side of the vehicle. For both screen orientation modes, the beam icons and beam selection buttons which are closer to the left side of the vehicle are applicable for the headlamps on the left

side. Those closer to the right side of the vehicle are applicable for the headlamps on the right side.

#### Related tasks

[Positioning in front of the headlamp](#) (pg. 85)

#### Related information

[Alignment with the vehicle](#) (pg. 62)

### 7.3.2 ECE - 15°/45° low beam sequence

This chapter explains the use of the OEM program selection for adjustment of *ECE* low beams with *manual determination* of the angle of the *cut-off line* (**ECE – 15° or 45°** angle).



**Note:** The **ECE-15/45** button has exactly the same functionality as the **Aiming** button (the *screwdriver* button) on the **Program selection** screen which was previously explained.

Tap on the **ECE-15/45** button 1 on the **OEM program selection** screen.

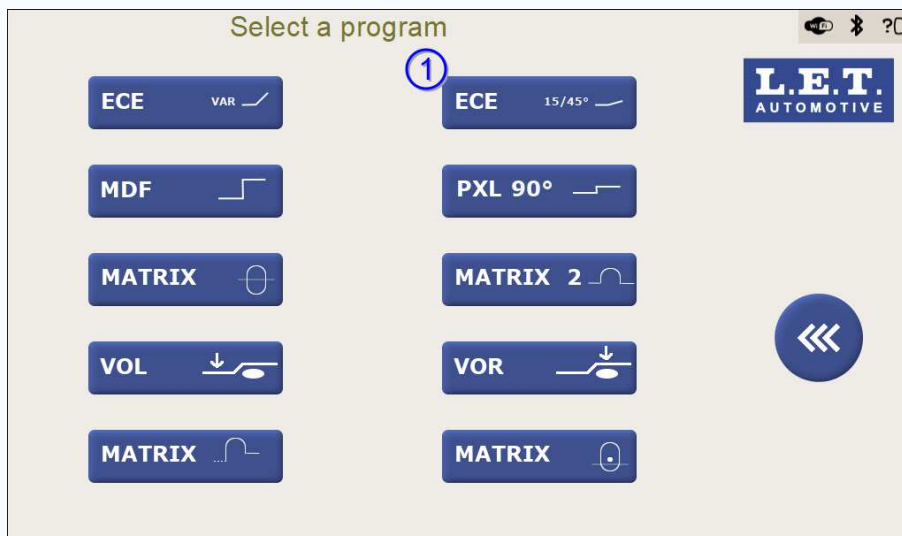

Figure 83: **OEM program selection** screen with **ECE-15/45** button

The **Beam selection** screen for the *ECE-15/45* program is now displayed.

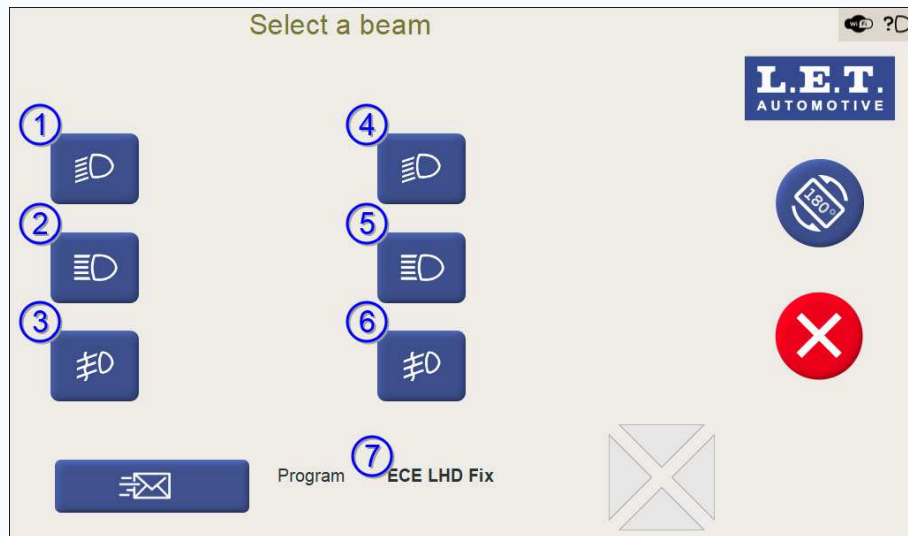

Figure 84: **Beam selection** screen for ECE-15/45 program

#	Button	Description
1	First ECE low beam	Starts the test of the first ECE low beam.
2	First high beam	Starts the test of the first high beam.
3	First fog beam	Starts the test of the first fog beam.
4	Second ECE low beam	Starts the test of the second ECE low beam.
5	Second high beam	Starts the test of the second high beam.
6	Second fog beam	Starts the test of the second fog beam.
7	Program name	<i>ECE LHD Fix</i> program.

**Note:** Rotating the screen position affects to the position of the beam icons and beam selection buttons on the screen. The intelligence of the Luminoscope® automatically places the beam icons and beam selection buttons on the correct side of the vehicle. For both screen orientation modes, the beam icons and beam selection buttons which are closer to the left side of the vehicle are applicable for the headlamps on the left side. Those closer to the right side of the vehicle are applicable for the headlamps on the right side.

#### Related information

[ECE or European low beam](#) (pg. 21)

[Left / right vehicle side definition](#) (pg. 61)

#### 7.3.2.1 Summary of the test sequence

What follows is a summarized listing of the steps for the test sequence. Refer to the next chapter for a detailed explanation of each step.

1. Align the Luminoscope® with the vehicle.

2. Tap on the beam selection button corresponding with the left or right *ECE* low beam.
3. Position the Luminoscope® sequentially in front of both *ECE* low beams.
4. Adjust both *ECE* low beams sequentially.

### 7.3.2.2 Test sequence

1. Align the Luminoscope® with the vehicle.

Before the start of the actual test, the Luminoscope® should be properly aligned with the longitudinal axis (driving direction) of the vehicle. This is crucial in order to minimize the measurement result error in the horizontal direction. At the end of the chapter there is a link with related information on how to align the Luminoscope®.

**The next three steps are to be applied to both *ECE* low beams sequentially.**

2. Tap on the beam selection button corresponding with the left or right *ECE* low beam on the **Beam selection** screen to start its calibration.



**Note:** Rotating the screen position affects to the position of the beam icons and beam selection buttons on the screen. The intelligence of the Luminoscope® automatically places the beam icons and beam selection buttons on the correct side of the vehicle. For both screen orientation modes, the beam icons and beam selection buttons which are closer to the left side of the vehicle are applicable for the headlamps on the left side. Those closer to the right side of the vehicle are applicable for the headlamps on the right side.

3. Position the Luminoscope® in front of the selected *ECE* low beam.

Make use of the electronic *Position Check* system.

Once the optimal position in front of the headlamp is achieved, the Luminoscope® proceeds automatically to the next phase in the test.

4. Adjust the selected *ECE* low beam.

Both *ECE* low beams should be adjusted with exactly the same procedure.



**Note:** The *ECE* low beam algorithm is capable to determine the horizontal and vertical position of the *V-point* (also called *elbow point* or *kink point*) of the *cut-off* line. Each time the **Cut-off angle** button is tapped, the selected angle of the low beam tolerance overlay changes between 15° and 45°. In most common cases the default selection of 15° can be used. Use the 45° selection only for *ECE* low beam *cut-off* lines with a 45° step. It is important to correctly set the angle because it has a direct consequence on the horizontal algorithm measurement position (determination of the *V-point*) of the *cut-off* line.

In case of an *ECE LHD* (Left Hand Drive) low beam with a 15° angle:

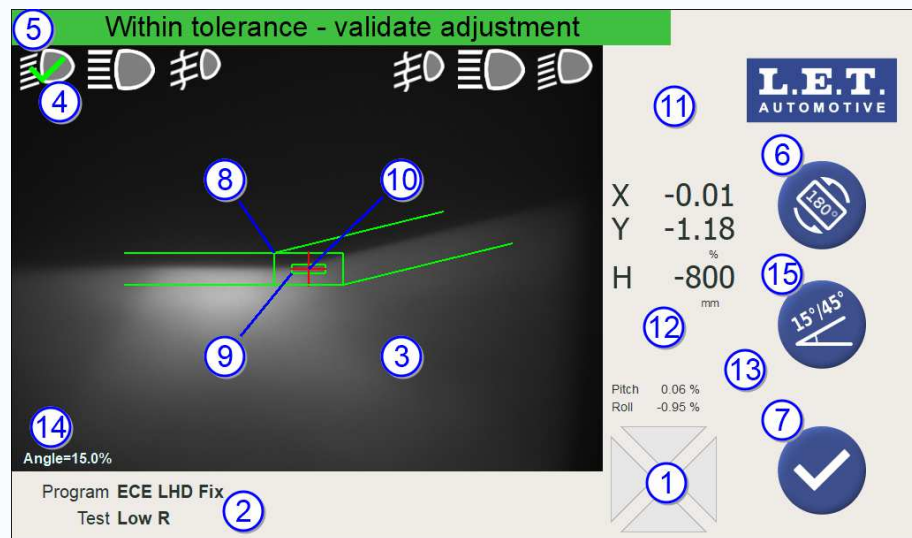

Figure 85: Right ECE low beam with 15° angle adjustment

In case of an *ECE LHD* (Left Hand Drive) low beam with a 45° angle:

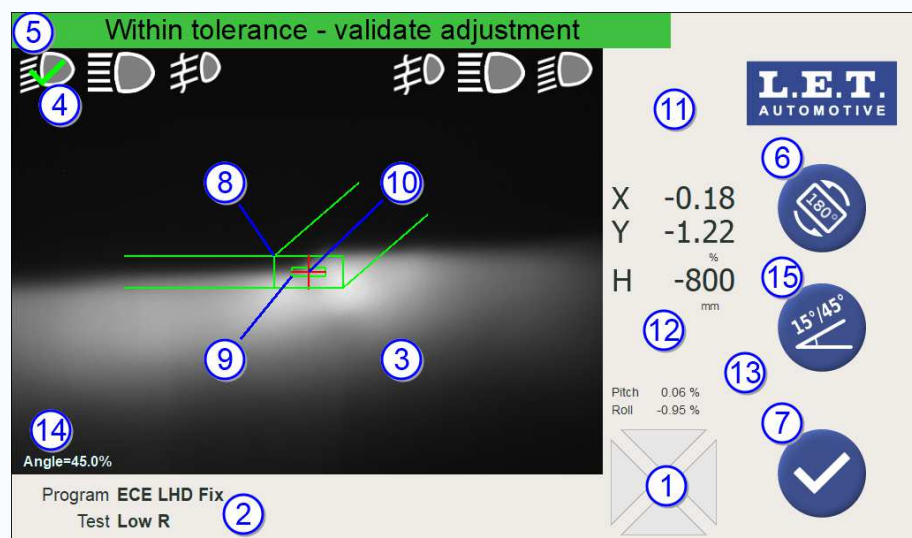

Figure 86: Right ECE low beam with 45° angle adjustment

#	Name	Description
1	Position Check Arrows	Indicates the direction(s) on which the optical block should be moved to achieve the optimal position in front of the headlamp. This position can change when adjusting the headlamp.
2	Information field	Depending on the Luminoscope® configuration, some related information such as the name of the selected program (Vehicle), the name of the test (Beam), license plate, etc. will be displayed.
3	Live headlamp beam image	Real time image of the headlamp beam including overlays for tolerance zone(s), algorithm measurement position, etc.

#	Name	Description
4	Low beam icon	<p>Low beam icon indicating the status of the beam.</p> <p>The meaning of the icon depends on its shape and color:</p> <ul style="list-style-type: none"> <li>• <b>Yellow</b> mark means <b>Test in progress</b>.</li> <li>• <b>Green</b> V-sign means <b>In tolerance</b>.</li> <li>• <b>Red</b> cross means <b>Out of tolerance</b>.</li> </ul>
5	Information banner	The information banner shows different status messages such as: <b>Test in progress</b> , <b>Within tolerance</b> , <b>Out of tolerance</b> , etc. Status, error or warning messages can also be displayed over there.
6	<b>Rotate screen</b> button	Rotate the screen position.
7	<b>Validation</b> button	If the <i>live validation</i> function is activated, tapping on this button will store the beam measurement result. The result is unconditionally stored whether the algorithm measurement position is <i>Within tolerance</i> or <i>Out of tolerance</i> .
8	Audit tolerance zone	The <i>audit tolerance zone</i> allows the operator to check if the headlamp is within the audit tolerances that are applicable in a government inspection station.
9	Aiming tolerance zone	The aiming tolerance zone allows the operator to adjust the headlamp correctly. Note that the aiming tolerance zone should always be smaller than the audit tolerance zone. This is to ensure that a correctly aimed headlamp at a workshop ( <i>using the smaller aiming tolerance zone</i> ) will pass the test in a government inspection station ( <i>using the larger audit tolerance zone</i> ).
10	Algorithm measurement position	The algorithm overlay (red cross) represents the algorithm measurement position on the headlamp beam image. In case of an aiming cycle, the red cross position should be aimed towards the centre of the aiming tolerance zone. In case of an audit cycle, the red cross position is evaluated. The actual position is displayed on the headlamp measurement result field.
11	Beam direction arrows	<p>The beam direction arrows indicate the direction(s) in which the headlamp should be moved to reach the target position inside the tolerance zone.</p> <p>The colour of the arrows indicates the live status of the aiming:</p> <ul style="list-style-type: none"> <li>• <b>Green</b> means the result is <i>inside</i> the tolerance zone.</li> <li>• <b>Yellow</b> means the result is <i>close</i> to the tolerance zone.</li> <li>• <b>Red</b> means the result is <i>far away</i> from the tolerance zone.</li> </ul>
12	Headlamp measurement results field	Depending on the chosen algorithm and Luminoscope® configuration, headlamp measurement results such as horizontal beam position (X), vertical beam position (Y), etc. are displayed here.

#	Name	Description
13	ESL (Electronic Spirit Level) module angles	Measured Pitch and Roll angle of the ESL (Electronic Spirit Level) module, if applicable.
14	Cut-off angle field	The angle of the ECE low beam cut-off line is displayed here.
15	Cut-off angle button	Each time the <b>Cut-off angle</b> button is tapped, the selected angle of the low beam tolerance overlay changes between 15° and 45°. In most common cases the default selection of 15° can be used. Use the 45° selection only for ECE low beam cut-off lines with a 45° step. It is important to correctly set the angle because it has a direct consequence on the horizontal algorithm measurement position (determination of the <i>V-point</i> ) of the cut-off line.

The following **Beam selection** screen is shown when both ECE low beams are properly adjusted.

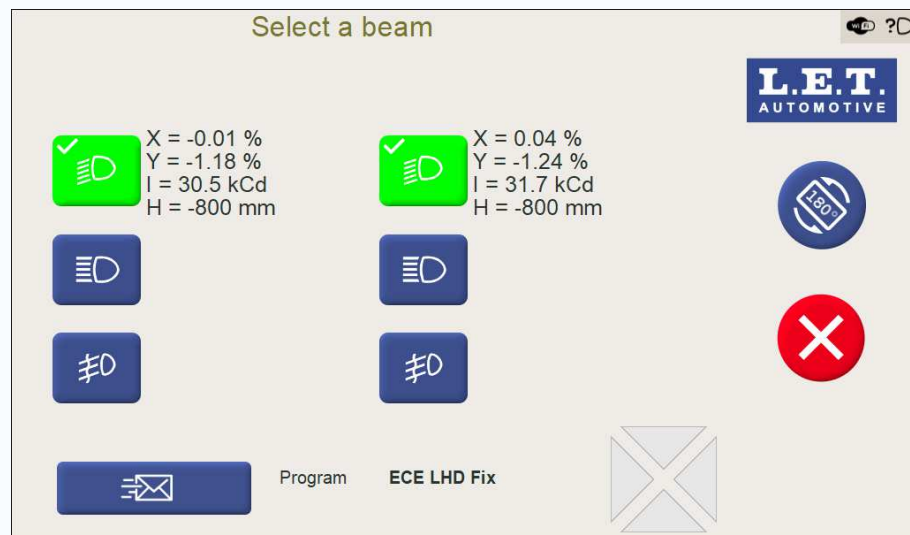

Figure 87: **Beam selection** screen with ECE low beam test results



**Note:** Rotating the screen position affects to the position of the beam icons and beam selection buttons on the screen. The intelligence of the Luminoscope® automatically places the beam icons and beam selection buttons on the correct side of the vehicle. For both screen orientation modes, the beam icons and beam selection buttons which are closer to the left side of the vehicle are applicable for the headlamps on the left side. Those closer to the right side of the vehicle are applicable for the headlamps on the right side.

#### Related tasks

[Positioning in front of the headlamp \(pg. 85\)](#)

**Related information**

[Alignment with the vehicle](#) (pg. 62)

**7.3.3 MDF high beam sequence**

This chapter explains the use of the OEM program selection for *MDF* high beam adjustment. An *MDF* high beam, is a glare free high beam with motorization.

 **Note:** This specific *MDF* selection is only applicable to vehicles which have this function available.

 **Attention:** To perform the *MDF* high beam calibration, most of the vehicles need to be set in a special calibration mode to reveal the *MDF* pattern. A *vehicle diagnostic tester* must be connected to the *On Board Diagnostic (OBD)* port of the vehicle to switch the *MDF* high beams in a special calibration mode.

Refer to the specific instructions from the vehicle manufacturer in the vehicle manual.

 **Note:** The *MDF* high beam has to be physically adjusted with the headlamp adjustment screws.

Tap on the **MDF** button 1 on the **OEM program selection** screen.

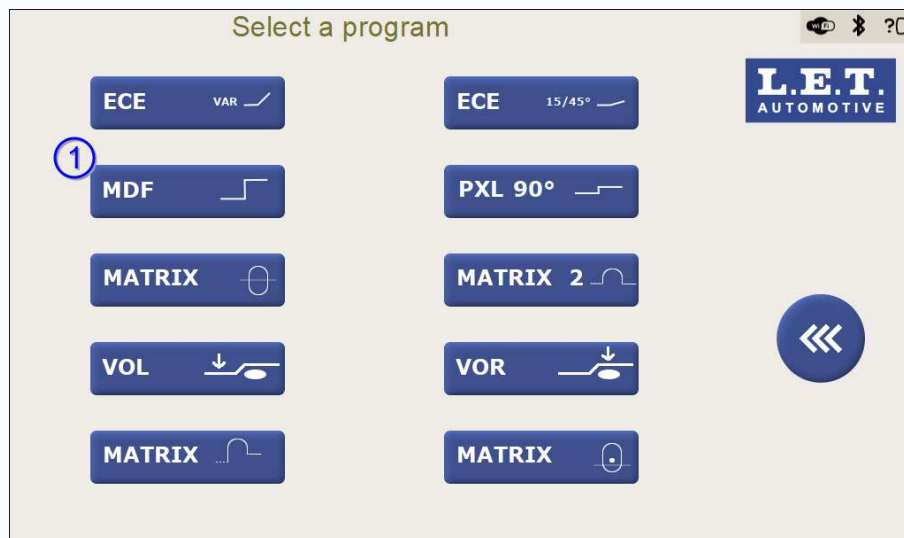

Figure 88: **OEM program selection** screen with **MDF** button

The **Beam selection** screen for the *MDF* program is now displayed.

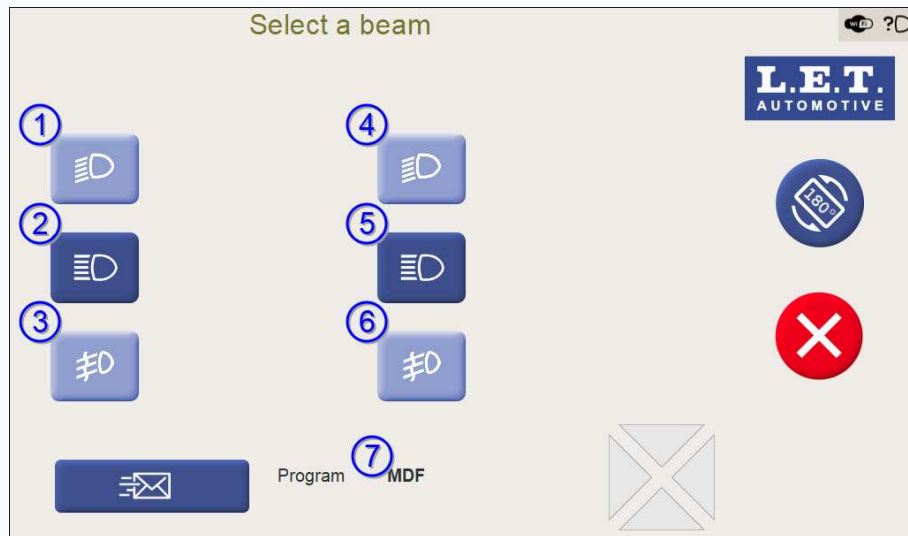

Figure 89: **Beam selection** screen for *MDF* program

#	Button	Description
1	First low beam	Starts the test of the first low beam.
2	First <i>MDF</i> high beam	Starts the test of the first <i>MDF</i> high beam.
3	First fog beam	Starts the test of the first fog beam.
4	Second low beam	Starts the test of the second low beam.
5	Second <i>MDF</i> high beam	Starts the test of the second <i>MDF</i> high beam.
6	Second fog beam	Starts the test of the second fog beam.
7	Program name	<i>MDF</i> program.

**Note:** Rotating the screen position affects to the position of the beam icons and beam selection buttons on the screen. The intelligence of the Luminoscope® automatically places the beam icons and beam selection buttons on the correct side of the vehicle. For both screen orientation modes, the beam icons and beam selection buttons which are closer to the left side of the vehicle are applicable for the headlamps on the left side. Those closer to the right side of the vehicle are applicable for the headlamps on the right side.

**Note:** The low and fog beam buttons on the **Beam selection** screen remain disabled until both *MDF* high beams are properly adjusted.

#### Related information

[Glare free high beam with beam motorisation](#) (pg. 26)

[Left / right vehicle side definition](#) (pg. 61)

#### 7.3.3.1 Summary of the test sequence

What follows is a summarized listing of the steps for the test sequence. Refer to the next chapter for a detailed explanation of each step.

1. Align the Luminoscope® with the vehicle.
2. Switch the high beams to *MDF* mode.
3. Tap on the beam selection button corresponding with the left or right *MDF* high beam.
4. Position the Luminoscope® sequentially in front of both *MDF* high beams.
5. Adjust both *MDF* high beams sequentially.
6. Switch on the low beams.
7. Tap on the beam selection button corresponding with the left or right low beam.
8. Position the Luminoscope® sequentially in front of both low beams.
9. Adjust both low beams sequentially in vertical direction only.

### 7.3.3.2 Test sequence

1. Align the Luminoscope® with the vehicle.

Before the start of the actual test, the Luminoscope® should be properly aligned with the longitudinal axis (driving direction) of the vehicle. This is crucial in order to minimize the measurement result error in the horizontal direction. At the end of the chapter there is a link with related information on how to align the Luminoscope®.

2. Switch the high beams to *MDF* mode.

To perform the *MDF* high beam calibration, most of the vehicles need to be set in a special calibration mode to reveal the *MDF* high beam pattern.

Refer to the specific instructions from the vehicle manufacturer in the vehicle manual.

**The next three steps are to be applied to both *MDF* high beams sequentially.**

3. Tap on the beam selection button corresponding with the left or right *MDF* high beam on the **Beam selection** screen to start its calibration.



**Note:** Rotating the screen position affects to the position of the beam icons and beam selection buttons on the screen. The intelligence of the Luminoscope® automatically places the beam icons and beam selection buttons on the correct side of the vehicle. For both screen orientation modes, the beam icons and beam selection buttons which are closer to the left side of the vehicle are applicable for the headlamps on the left side. Those closer to the right side of the vehicle are applicable for the headlamps on the right side.

4. Position the Luminoscope® in front of the selected *MDF* high beam.

Make use of the electronic *Position Check* system.

Once the optimal position in front of the headlamp is achieved, the Luminoscope® proceeds automatically to the next phase in the test.

5. Adjust the selected *MDF* high beam.

Both *MDF* high beams should be adjusted towards the tolerance zone in horizontal direction (X direction) and vertical direction (Y direction).

The projection of the left and right *MDF* high beams differ from each other.

**Note:** The *MDF* high beam algorithm is capable to determine the *kink* point on the lower horizontal line of the *MDF* high beam *cut-off* line. The *MDF* high beam *cut-off* line has a 90° step.

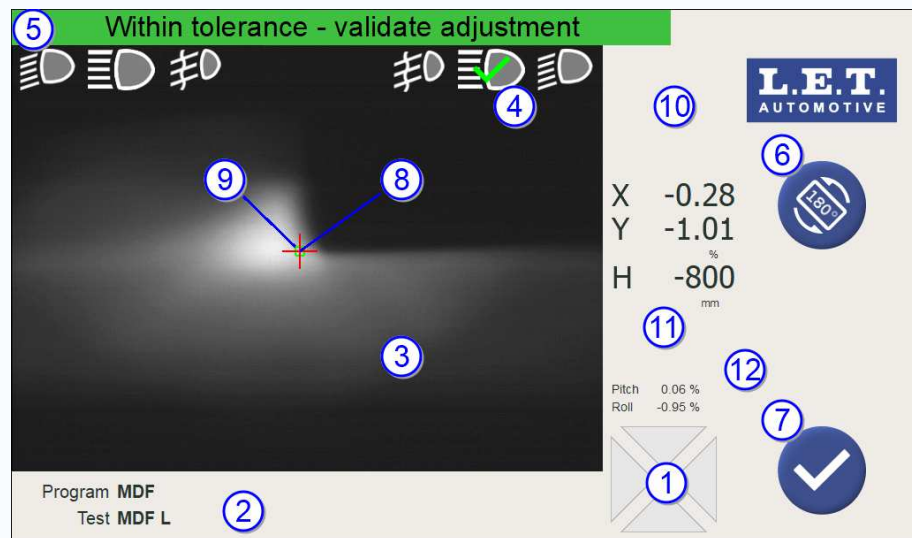

Figure 90: Left *MDF* high beam adjustment

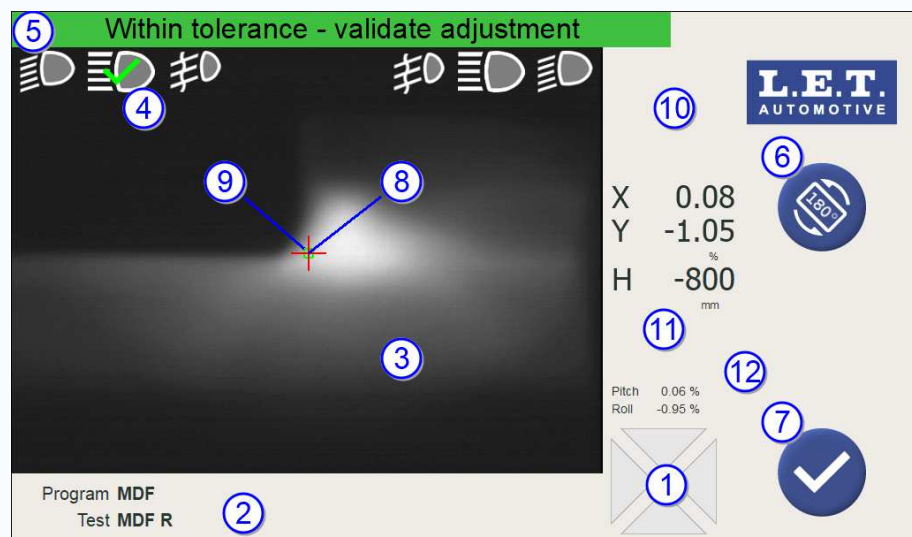

Figure 91: Right *MDF* high beam adjustment

#	Name	Description
1	<i>Position Check Arrows</i>	Indicates the direction(s) on which the optical block should be moved to achieve the optimal position in front of the headlamp. This position can change when adjusting the headlamp.
2	Information field	Depending on the Luminoscope® configuration, some related information such as the name of the selected program (Vehicle), the name of the test (Beam), license plate, etc. will be displayed.
3	Live headlamp beam image	Real time image of the headlamp beam including overlays for tolerance zone(s), algorithm measurement position, etc.
4	High beam icon	High beam icon indicating the status of the beam. The meaning of the icon depends on its shape and color: <ul style="list-style-type: none"> <li>• <b>Yellow</b> mark means <b>Test in progress</b>.</li> <li>• <b>Green</b> V-sign means <b>In tolerance</b>.</li> <li>• <b>Red</b> cross means <b>Out of tolerance</b>.</li> </ul>
5	Information banner	The information banner shows different status messages such as: <b>Test in progress</b> , <b>Within tolerance</b> , <b>Out of tolerance</b> , etc. Status, error or warning messages can also be displayed over there.
6	<b>Rotate screen</b> button	Rotate the screen position.
7	<b>Validation</b> button	If the <i>live validation</i> function is activated, tapping on this button will store the beam measurement result. The result is unconditionally stored whether the algorithm measurement position is <i>Within tolerance</i> or <i>Out of tolerance</i> .
8	Algorithm measurement position	The algorithm overlay (red cross) represents the algorithm measurement position on the headlamp beam image. In case of an aiming cycle, the red cross position should be aimed towards the centre of the aiming tolerance zone. In case of an audit cycle, the red cross position is evaluated. The actual position is displayed on the headlamp measurement result field.
9	Aiming tolerance zone	The aiming tolerance zone allows the operator to adjust the headlamp correctly. Note that the aiming tolerance zone should always be smaller than the audit tolerance zone. This is to ensure that a correctly aimed headlamp at a workshop ( <i>using the smaller aiming tolerance zone</i> ) will pass the test in a government inspection station ( <i>using the larger audit tolerance zone</i> ).

#	Name	Description
10	Beam direction arrows	<p>The beam direction arrows indicate the direction(s) in which the headlamp should be moved to reach the target position inside the tolerance zone.</p> <p>The colour of the arrows indicates the live status of the aiming:</p> <ul style="list-style-type: none"> <li>• <b>Green</b> means the result is <i>inside</i> the tolerance zone.</li> <li>• <b>Yellow</b> means the result is <i>close</i> to the tolerance zone.</li> <li>• <b>Red</b> means the result is <i>far away</i> from the tolerance zone.</li> </ul>
11	Headlamp measurement results field	Depending on the chosen algorithm and Luminoscope® configuration, headlamp measurement results such as horizontal beam position (X), vertical beam position (Y), etc. are displayed here.
12	ESL (Electronic Spirit Level) module angles	Measured Pitch and Roll angle of the ESL (Electronic Spirit Level) module, if applicable.

The following **Beam selection** screen is shown when both *MDF* high beams are properly adjusted.

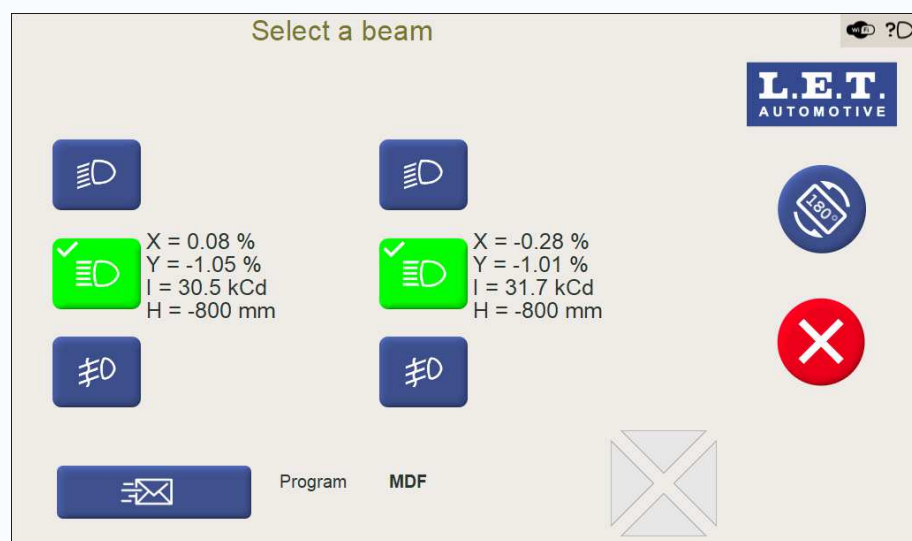

Figure 92: **Beam selection** screen with *MDF* high beam test results



**Note:** Rotating the screen position affects to the position of the beam icons and beam selection buttons on the screen. The intelligence of the Luminoscope® automatically places the beam icons and beam selection buttons on the correct side of the vehicle. For both screen orientation modes, the beam icons and beam selection buttons which are closer to the left side of the vehicle are applicable for the headlamps on the left side. Those closer to the right side of the vehicle are applicable for the headlamps on the right side.

**6.** Switch on the low beams.

Refer to the specific instructions from the vehicle manufacturer in the vehicle manual.

**The next three steps are to be applied to both low beams sequentially.**

**7.** Tap on the beam selection button corresponding with the left or right low beam on the **Beam selection** screen to start its calibration.

**Note:** Rotating the screen position affects to the position of the beam icons and beam selection buttons on the screen. The intelligence of the Luminoscope® automatically places the beam icons and beam selection buttons on the correct side of the vehicle. For both screen orientation modes, the beam icons and beam selection buttons which are closer to the left side of the vehicle are applicable for the headlamps on the left side. Those closer to the right side of the vehicle are applicable for the headlamps on the right side.

**8.** Position the Luminoscope® in front of the selected low beam.

Make use of the electronic *Position Check* system.

Once the optimal position in front of the headlamp is achieved, the Luminoscope® proceeds automatically to the next phase in the test.

**9.** Adjust the selected low beam in vertical direction only.

Both low beams should be adjusted towards the tolerance zone in vertical direction (Y direction) only.



**Attention:** It is not allowed to adjust the horizontal direction (X direction) of the low beams as this has a direct influence on the previously performed calibration of the *MDF* high beams.



**Note:** The *ECE* low beam algorithm is capable to determine the horizontal and vertical position of the *V-point* (also called *elbow* point or *kink* point) of the *cut-off* line.

**Related tasks**

[Positioning in front of the headlamp](#) (pg. 85)

[Low beam test](#) (pg. 88)

**Related information**

[Alignment with the vehicle](#) (pg. 62)

**7.3.4 PIXEL 90 low beam sequence**

This chapter explains the use of the OEM program selection for *PIXEL 90* (*PXL90*) low beam adjustment. A *PIXEL 90* low beam headlamp, is a low beam where the known *ECE* – 15° or 45° angle is replaced by a 90° angle..



**Attention:** To perform this calibration, the vehicle must be set on a special calibration mode. This is achieved either through the connection of an *On Board Diagnostic* device (*OBD*) to the corresponding port of the vehicle, or by any other process provided by the manufacturer. This switches on the *PIXEL 90* low beams and later on, the *Matrix* high beams in a special calibration mode.

Follow the specific instructions from the vehicle manufacturer on the dialog screen of the *vehicle diagnostic tester*.



**Note:** The *PIXEL 90* low beam has to be physically adjusted with the headlamp adjustment screws, as it is done for standard low beams.

Tap on the **PXL 90°** button 1 on the **OEM program selection** screen.

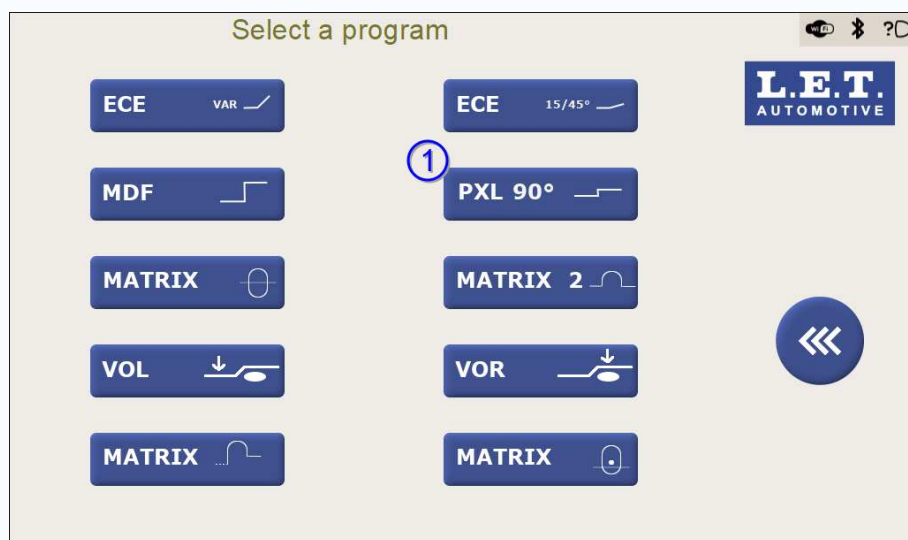

Figure 93: **OEM program selection** screen with **PXL 90°** button

The **Beam selection** screen for the *PIXEL 90* program is now displayed.

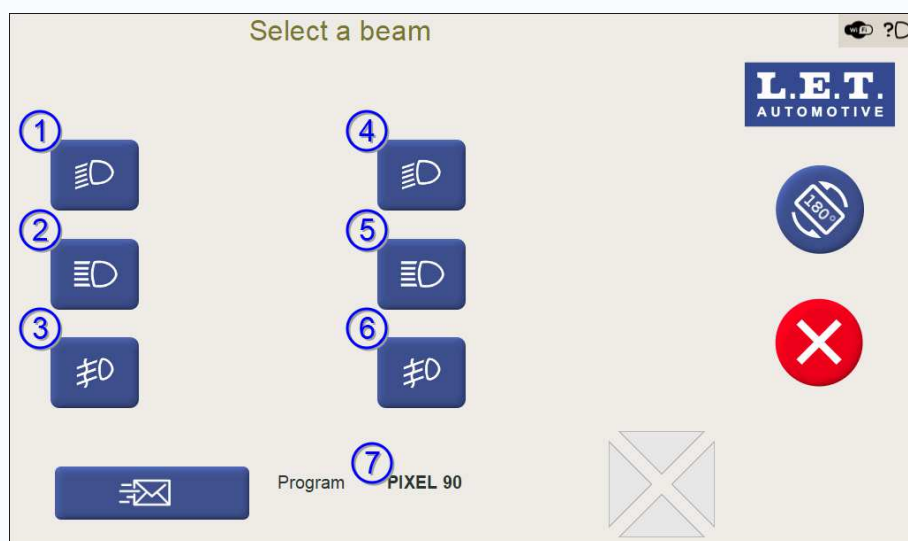

Figure 94: **Beam selection** screen for *PIXEL 90* program

#	Button	Description
1	First <i>PIXEL 90</i> low beam	Starts the test of the first <i>PIXEL 90</i> low beam.
2	First <i>Matrix</i> high beam	Starts the test of the first <i>Matrix</i> high beam.
3	First fog beam	Starts the test of the first fog beam.
4	Second <i>PIXEL 90</i> low beam	Starts the test of the second <i>PIXEL 90</i> low beam.
5	Second <i>Matrix</i> high beam	Starts the test of the second <i>Matrix</i> high beam.
6	Second fog beam	Starts the test of the second fog beam.
7	Program name	<i>PIXEL 90</i> program.



**Note:** Rotating the screen position affects to the position of the beam icons and beam selection buttons on the screen. The intelligence of the Luminoscope® automatically places the beam icons and beam selection buttons on the correct side of the vehicle. For both screen orientation modes, the beam icons and beam selection buttons which are closer to the left side of the vehicle are applicable for the headlamps on the left side. Those closer to the right side of the vehicle are applicable for the headlamps on the right side.

#### Related information

[Dynamic low beam](#) (pg. 28)

[Left / right vehicle side definition](#) (pg. 61)

#### 7.3.4.1 Summary of the test sequence

What follows is a summarized listing of the steps for the test sequence. Refer to the next chapter for a detailed explanation of each step.

1. Align the Luminoscope® with the vehicle.
2. Establish an *OBD* connection with the *vehicle diagnostic tester*.
3. Switch the *PIXEL 90* low beams to calibration mode.
4. Tap on the beam selection button corresponding with the left or right *PIXEL 90* low beam.
5. Position the Luminoscope® sequentially in front of both *PIXEL 90* low beams.
6. Adjust both *PIXEL 90* low beams sequentially.
7. Switch the *Matrix* high beams in a special calibration mode.
8. Calibrate the left *Matrix* and right *Matrix* high beam.
9. Exit the calibration mode.

### 7.3.4.2 Test sequence

1. Align the Luminoscope® with the vehicle.

Before the start of the actual test, the Luminoscope® should be properly aligned with the longitudinal axis (driving direction) of the vehicle. This is crucial in order to minimize the measurement result error in the horizontal direction. At the end of the chapter there is a link with related information on how to align the Luminoscope®.

2. Establish an *OBD* connection with the *vehicle diagnostic tester*.

The *vehicle diagnostic tester* must be connected to the *On Board Diagnostic (OBD)* port of the vehicle to switch the *PIXEL 90* low beams and later on the *Matrix* high beams in a special calibration mode.

Follow the specific instructions from the vehicle manufacturer on the dialog screen of the *vehicle diagnostic tester*.

3. Switch the *PIXEL 90* low beams to calibration mode.

Follow the specific instructions from the vehicle manufacturer on the dialog screen of the *vehicle diagnostic tester*.

**The next three steps are to be applied to both *PIXEL 90* low beams sequentially.**

4. Tap on the beam selection button corresponding with the left or right *PIXEL 90* low beam on the **Beam selection** screen to start its calibration.



**Note:** Rotating the screen position affects to the position of the beam icons and beam selection buttons on the screen. The intelligence of the Luminoscope® automatically places the beam icons and beam selection buttons on the correct side of the vehicle. For both screen orientation modes, the beam icons and beam selection buttons which are closer to the left side of the vehicle are applicable for the headlamps on the left side. Those closer to the right side of the vehicle are applicable for the headlamps on the right side.

5. Position the Luminoscope® in front of the selected *PIXEL 90* low beam.

Position the Luminoscope® in front of the selected *PIXEL 90* low beam projection, in such a way the light beam shines through the centre of the lens of the Luminoscope® while observing the beam projection on the lens of the Luminoscope®.



Figure 95: **Positioning** screen

If at that center position, all *Position Check* arrows have disappeared, the Luminoscope® proceeds automatically to the next phase in the test. If however not all arrows have disappeared after visually positioning the centre of the Luminoscope® lens in front of the beam, tap on the **Skip Position Check** button 2 to proceed.

**6.** Adjust the selected *PIXEL 90* low beam.

Both *PIXEL 90* low beams should be adjusted with exactly the same procedure.

**i Note:** The *PIXEL 90* low beam algorithm is capable to determine the *kink* point on the lower horizontal line of the *PIXEL 90* low beam *cut-off* line. The *PIXEL 90* low beam *cut-off* line has a 90° step.

**i Note:** The horizontal target value is set at +0,7% (+7 cm/10m).

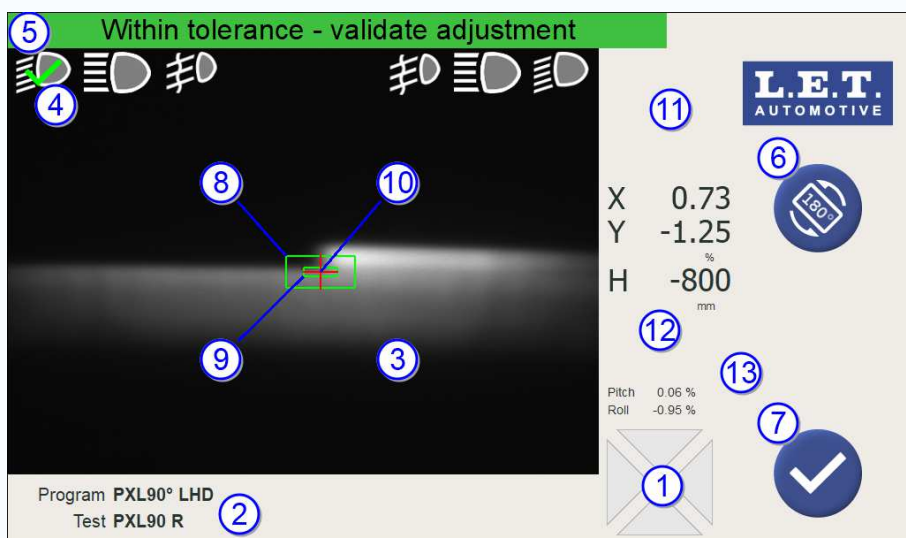

Figure 96: **Right PIXEL 90** low beam adjustment

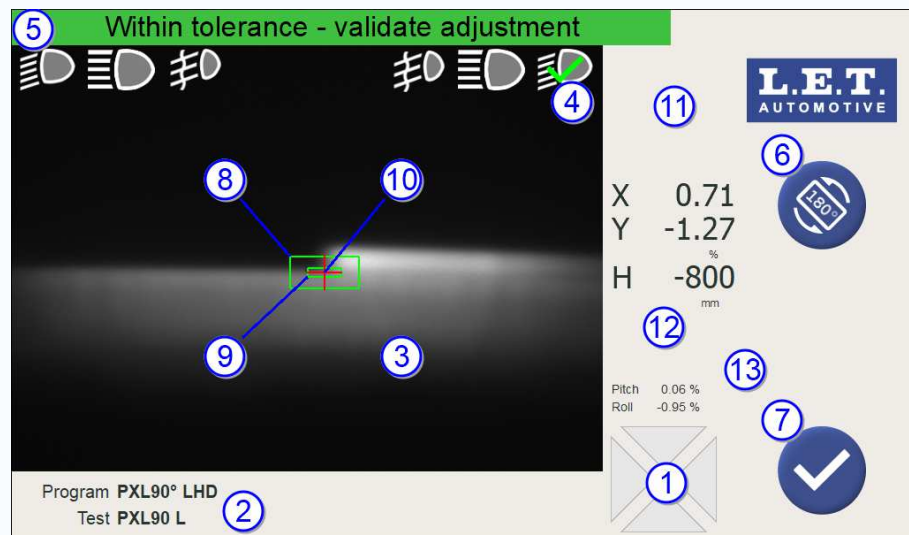

Figure 97: Left PIXEL 90 low beam adjustment

#	Name	Description
1	<i>Position Check Arrows</i>	Indicates the direction(s) on which the optical block should be moved to achieve the optimal position in front of the headlamp. This position can change when adjusting the headlamp.
2	Information field	Depending on the Luminoscope® configuration, some related information such as the name of the selected program (Vehicle), the name of the test (Beam), license plate, etc. will be displayed.
3	Live headlamp beam image	Real time image of the headlamp beam including overlays for tolerance zone(s), algorithm measurement position, etc.
4	Low beam icon	Low beam icon indicating the status of the beam. The meaning of the icon depends on its shape and color: <ul style="list-style-type: none"> <li>• <b>Yellow</b> mark means <b>Test in progress</b>.</li> <li>• <b>Green</b> V-sign means <b>In tolerance</b>.</li> <li>• <b>Red</b> cross means <b>Out of tolerance</b>.</li> </ul>
5	Information banner	The information banner shows different status messages such as: <b>Test in progress</b> , <b>Within tolerance</b> , <b>Out of tolerance</b> , etc. Status, error or warning messages can also be displayed over there.
6	<b>Rotate screen</b> button	Rotate the screen position.
7	<b>Validation</b> button	If the <i>live validation</i> function is activated, tapping on this button will store the beam measurement result. The result is unconditionally stored whether the algorithm measurement position is <i>Within tolerance</i> or <i>Out of tolerance</i> .
8	Audit tolerance zone	The <i>audit tolerance zone</i> allows the operator to check if the headlamp is within the audit tolerances that are applicable in a government inspection station.

#	Name	Description
9	Aiming tolerance zone	The aiming tolerance zone allows the operator to adjust the headlamp correctly. Note that the aiming tolerance zone should always be smaller than the audit tolerance zone. This is to ensure that a correctly aimed headlamp at a workshop ( <i>using the smaller aiming tolerance zone</i> ) will pass the test in a government inspection station ( <i>using the larger audit tolerance zone</i> ).
10	Algorithm measurement position	The algorithm overlay (red cross) represents the algorithm measurement position on the headlamp beam image. In case of an aiming cycle, the red cross position should be aimed towards the centre of the aiming tolerance zone. In case of an audit cycle, the red cross position is evaluated. The actual position is displayed on the headlamp measurement result field.
11	Beam direction arrows	The beam direction arrows indicate the direction(s) in which the headlamp should be moved to reach the target position inside the tolerance zone.  The colour of the arrows indicates the live status of the aiming: <ul style="list-style-type: none"> <li>• <b>Green</b> means the result is <i>inside</i> the tolerance zone.</li> <li>• <b>Yellow</b> means the result is <i>close</i> to the tolerance zone.</li> <li>• <b>Red</b> means the result is <i>far away</i> from the tolerance zone.</li> </ul>
12	Headlamp measurement results field	Depending on the chosen algorithm and Luminoscope® configuration, headlamp measurement results such as horizontal beam position (X), vertical beam position (Y), etc. are displayed here.
13	ESL (Electronic Spirit Level) module angles	Measured Pitch and Roll angle of the ESL (Electronic Spirit Level) module, if applicable.

The following **Beam selection** screen is shown when both *PIXEL 90* low beams are properly adjusted.

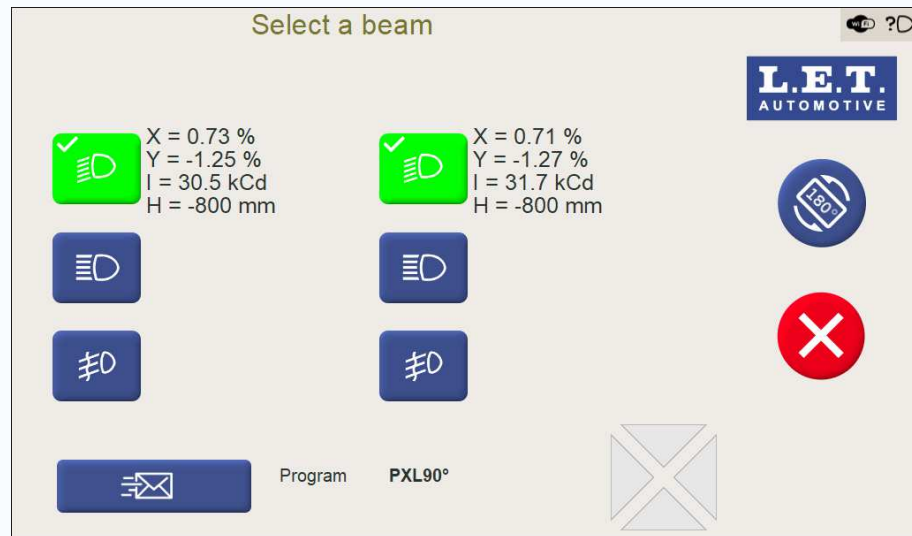

Figure 98: **Beam selection** screen with PIXEL 90 low beam test results

**Note:** Rotating the screen position affects to the position of the beam icons and beam selection buttons on the screen. The intelligence of the Luminoscope® automatically places the beam icons and beam selection buttons on the correct side of the vehicle. For both screen orientation modes, the beam icons and beam selection buttons which are closer to the left side of the vehicle are applicable for the headlamps on the left side. Those closer to the right side of the vehicle are applicable for the headlamps on the right side.

7. Switch the *Matrix* high beams in a special calibration mode.

Follow the specific instructions from the vehicle manufacturer on the dialog screen of the *vehicle diagnostic tester*.

8. Calibrate the left *Matrix* and right *Matrix* high beam.

**Note:** The *Matrix* high beam will not be physically adjusted (e.g. with headlamp adjustment screws). The horizontal position of the left or right flank (depending on the vehicle side) of one reference *LED* source of the *Matrix* high beam is measured by the Luminoscope®. The measured position should be stored afterwards in the *electrical control unit (ECU)* of the vehicle by means of manual entry in the *vehicle diagnostic tester* that is connected to the *OBD* port of the vehicle.

Follow the specific instructions from the vehicle manufacturer on the dialog screen of the *vehicle diagnostic tester*.

Calibrate the left *Matrix* high beam first and then, the right *Matrix* high beam. After each calibration, the measured position should be entered in the vehicle diagnostic tester.

Follow the instructions as explained in the related chapter listed at the end of the chapter.

9. Exit the calibration mode.

Follow the specific instructions from the vehicle manufacturer on the dialog screen of the *vehicle diagnostic tester*.

**Related tasks**

[VW/AUDI Matrix high beam sequence](#) (pg. 130)

**Related information**

[Alignment with the vehicle](#) (pg. 62)

### 7.3.5 VW/AUDI *Matrix* high beam sequence

This chapter explains the use of the OEM program selection for *Matrix* high beam calibration. A *Matrix* high beam, is a glare free high beam with multiple *LED* sources.



**Note:** This specific *Matrix* selection is only applicable to vehicles of the *VW-Audi* group which feature *Matrix* beams.



**Attention:** To perform this calibration, a *vehicle diagnostic tester* must be connected to the *On Board Diagnostic (OBD)* port of the vehicle to switch the *Matrix* high beams in a special calibration mode.

Follow the specific instructions from the vehicle manufacturer on the dialog screen of the *vehicle diagnostic tester*.



**Note:** The *Matrix* high beam will not be physically adjusted (e.g. with headlamp adjustment screws). The horizontal position of the left or right flank (depending on the vehicle side) of one reference *LED* source of the *Matrix* high beam is measured by the Luminoscope®. The measured position should be stored afterwards in the *electrical control unit (ECU)* of the vehicle by means of manual entry in the *vehicle diagnostic tester* that is connected to the *OBD* port of the vehicle.

Tap on the **VW/Audi Matrix** button 1 on the **OEM program selection** screen.

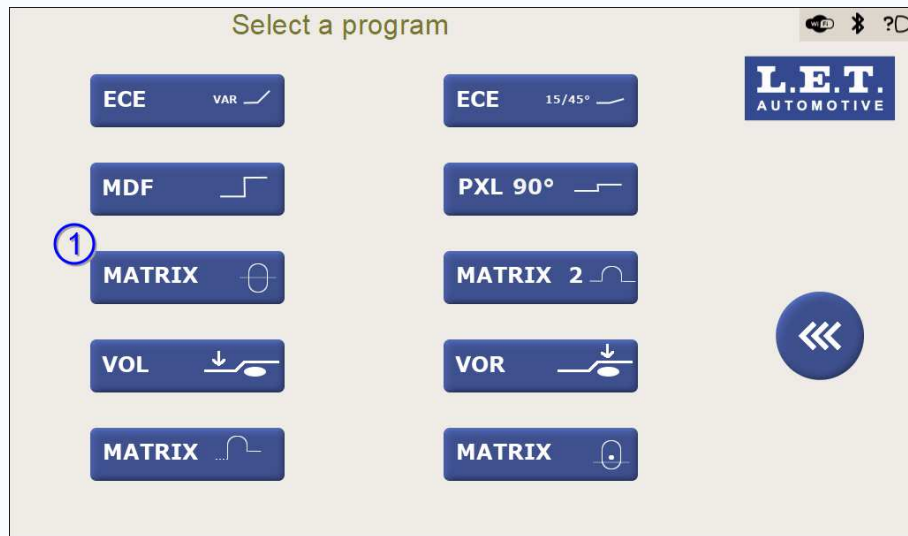

Figure 99: **OEM program selection** screen with **VW/Audi Matrix** button

The **Beam selection** screen for the **VW/Audi Matrix** program is now displayed.

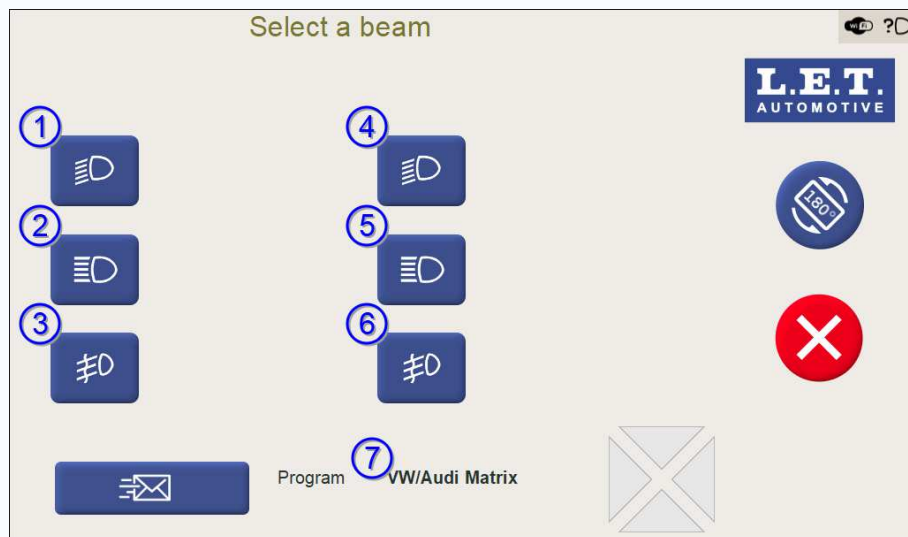

Figure 100: **Beam selection** screen for **VW/Audi Matrix** program

#	Button	Description
1	First low beam	Starts the test of the first low beam.
2	First <i>Matrix</i> high beam	Starts the test of the first <i>Matrix</i> high beam.
3	First fog beam	Starts the test of the first fog beam.
4	Second low beam	Starts the test of the second low beam.
5	Second <i>Matrix</i> high beam	Starts the test of the second <i>Matrix</i> high beam.
6	Second fog beam	Starts the test of the second fog beam.
7	Program name	<i>VW/Audi Matrix</i> program.



**Note:** Rotating the screen position affects to the position of the beam icons and beam selection buttons on the screen. The intelligence of the Luminoscope® automatically places the beam icons and beam selection

buttons on the correct side of the vehicle. For both screen orientation modes, the beam icons and beam selection buttons which are closer to the left side of the vehicle are applicable for the headlamps on the left side. Those closer to the right side of the vehicle are applicable for the headlamps on the right side.

### Related information

[Glare free high beam with multiple static LED sources \(pg. 27\)](#)

[Left / right vehicle side definition \(pg. 61\)](#)

### 7.3.5.1 Summary of the test sequence

What follows is a summarized listing of the steps for the test sequence. Refer to the next chapter for a detailed explanation of each step.

1. Align the Luminoscope® with the vehicle.
2. Establish an *OBD* connection with the *vehicle diagnostic tester*.
3. Adjust the low beams.
4. Switch the *Matrix* high beams in a special calibration mode.
5. Tap on the beam selection button corresponding with the left *Matrix* high beam.
6. Position the Luminoscope® in front of the left *Matrix* high beam.
7. Calibrate the left *Matrix* high beam.
8. Enter the measured position of the left *Matrix* high beam in the *vehicle diagnostic tester*.
9. Tap on the beam selection button corresponding with the right *Matrix* high beam.
10. Position the Luminoscope® in front of the right *Matrix* high beam.
11. Calibrate the right *Matrix* high beam.
12. Enter the measured position of the right *Matrix* high beam in the *vehicle diagnostic tester*.
13. Exit the calibration mode.

### 7.3.5.2 Test sequence

1. Align the Luminoscope® with the vehicle.  
Before the start of the actual test, the Luminoscope® should be properly aligned with the longitudinal axis (driving direction) of the vehicle. This is crucial in order to minimize

the measurement result error in the horizontal direction. At the end of the chapter there is a link with related information on how to align the Luminoscope®.

2. Establish an *OBD* connection with the *vehicle diagnostic tester*.

The *vehicle diagnostic tester* must be connected to the *On Board Diagnostic (OBD)* port of the vehicle to switch the *Matrix* high beam in a special calibration mode.

Follow the specific instructions from the vehicle manufacturer on the dialog screen of the *vehicle diagnostic tester*.

3. Adjust the low beams.

Both low beams should be adjusted properly before the *Matrix* high beam calibration can be performed.

The following **Beam selection** screen is shown when both low beams are properly adjusted.

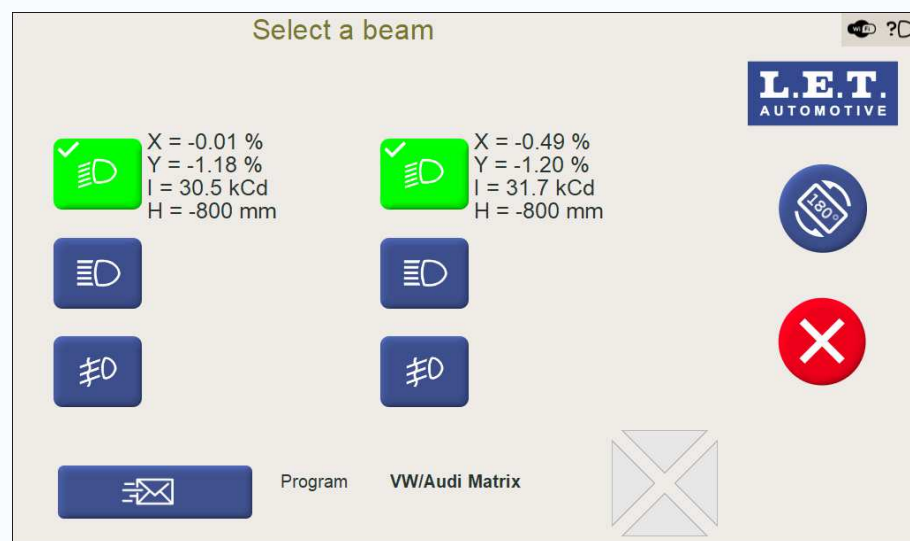

Figure 101: **Beam selection** screen with low beam test results

4. Switch the *Matrix* high beams in a special calibration mode.

Follow the specific instructions from the vehicle manufacturer on the dialog screen of the *vehicle diagnostic tester*.

5. Tap on the beam selection button corresponding with the left *Matrix* high beam on the **Beam selection** screen to start its calibration.



**Note:** Rotating the screen position affects to the position of the beam icons and beam selection buttons on the screen. The intelligence of the Luminoscope® automatically places the beam icons and beam selection buttons on the correct side of the vehicle. For both screen orientation modes, the beam icons and beam selection buttons which are closer to the left side of the vehicle are applicable for the headlamps on the left side. Those closer to the right side of the vehicle are applicable for the headlamps on the right side.

6. Position the Luminoscope® in front of the left *Matrix* high beam.

Position the Luminoscope® in front of the left *Matrix* high beam projection, in such a way the light beam shines through the centre of the lens of the Luminoscope® while observing the beam projection on the lens of the Luminoscope®.

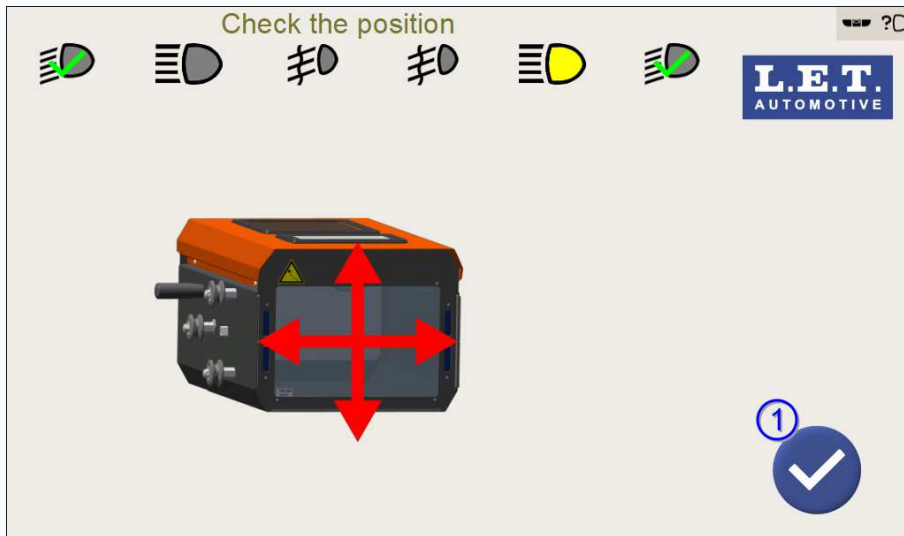

Figure 102: **Positioning** screen

Once the correct position is reached, tap on the **Validation** button 1 to proceed.

#### 7. Calibrate the left *Matrix* high beam.

The left *Matrix* high beam will not be physically adjusted (e.g. with headlamp screws). The horizontal position of the right flank of one reference *LED* source of the left *Matrix* high beam is measured by the Luminoscope®.



**Attention:** Note that the horizontal position (X value) is expressed in minutes.

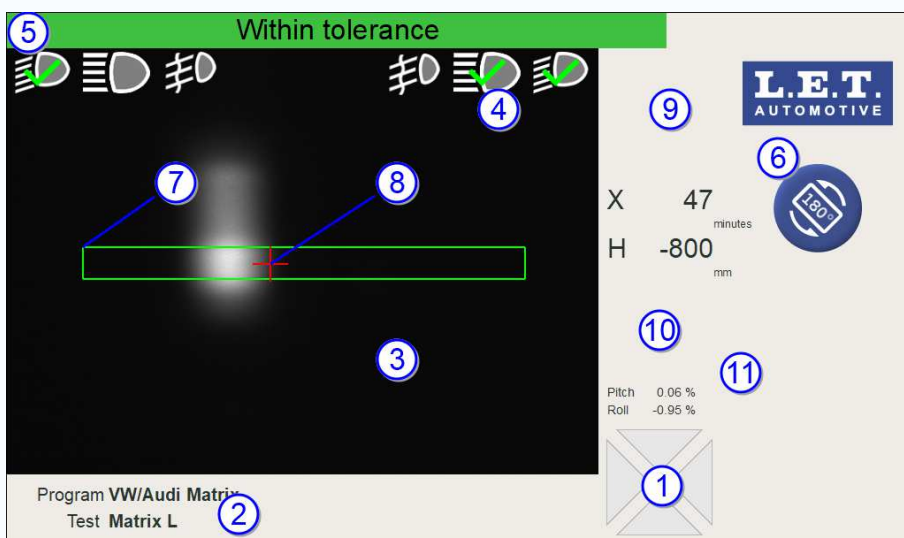

Figure 103: **Left Matrix high beam calibration**

#	Name	Description
1	<i>Position Check Arrows</i>	Indicates the direction(s) on which the optical block should be moved to achieve the optimal position in front of the headlamp. This position can change when adjusting the headlamp.
2	Information field	Depending on the Luminoscope® configuration, some related information such as the name of the selected program (Vehicle), the name of the test (Beam), license plate, etc. will be displayed.
3	Live headlamp beam image	Real time image of the headlamp beam including overlays for tolerance zone(s), algorithm measurement position, etc.
4	First high beam icon	<p>First high beam icon indicating the status of the beam.</p> <p>The meaning of the icon depends on its shape and color:</p> <ul style="list-style-type: none"> <li>• <b>Yellow</b> mark means <b>Test in progress</b>.</li> <li>• <b>Green</b> V-sign means <b>In tolerance</b>.</li> <li>• <b>Red</b> cross means <b>Out of tolerance</b>.</li> </ul>
5	Information banner	The information banner shows different status messages such as: <b>Test in progress</b> , <b>Within tolerance</b> , <b>Out of tolerance</b> , etc. Status, error or warning messages can also be displayed over there.
6	<b>Rotate screen</b> button	Rotate the screen position.
7	Audit tolerance zone	The <i>audit tolerance zone</i> allows the operator to check if the headlamp is within the audit tolerances that are applicable in a government inspection station.
8	Algorithm measurement position	The algorithm overlay (red cross) represents the algorithm measurement position on the headlamp beam image. In case of an aiming cycle, the red cross position should be aimed towards the centre of the aiming tolerance zone. In case of an audit cycle, the red cross position is evaluated. The actual position is displayed on the headlamp measurement result field.
9	Beam direction arrows	<p>The beam direction arrows indicate the direction(s) in which the headlamp should be moved to reach the target position inside the tolerance zone.</p> <p>The colour of the arrows indicates the live status of the aiming:</p> <ul style="list-style-type: none"> <li>• <b>Green</b> means the result is <i>inside</i> the tolerance zone.</li> <li>• <b>Yellow</b> means the result is <i>close</i> to the tolerance zone.</li> <li>• <b>Red</b> means the result is <i>far away</i> from the tolerance zone.</li> </ul>

#	Name	Description
10	Headlamp measurement results field	Depending on the chosen algorithm and Luminoscope® configuration, headlamp measurement results such as horizontal beam position (X), vertical beam position (Y), etc. are displayed here.
11	ESL (Electronic Spirit Level) module angles	Measured Pitch and Roll angle of the ESL (Electronic Spirit Level) module, if applicable.

8. Enter the measured position of the left *Matrix* high beam in the *vehicle diagnostic tester*.

The measured horizontal position should be stored afterwards in the *Electrical Control Unit* (ECU) of the vehicle by means of manual entry in the *vehicle diagnostic tester* that is connected to the *OBD* port of the vehicle.



**Attention:** Mind the sign of the horizontal position (X value)!

9. Tap on the beam selection button corresponding with the right *Matrix* high beam on the **Beam selection** screen to start its calibration.



**Note:** Rotating the screen position affects to the position of the beam icons and beam selection buttons on the screen. The intelligence of the Luminoscope® automatically places the beam icons and beam selection buttons on the correct side of the vehicle. For both screen orientation modes, the beam icons and beam selection buttons which are closer to the left side of the vehicle are applicable for the headlamps on the left side. Those closer to the right side of the vehicle are applicable for the headlamps on the right side.

10. Position the Luminoscope® in front of the right *Matrix* high beam.

Position the Luminoscope® in front of the right *Matrix* high beam projection, in such a way the light beam shines through the centre of the lens of the Luminoscope® while observing the beam projection on the lens of the Luminoscope®.

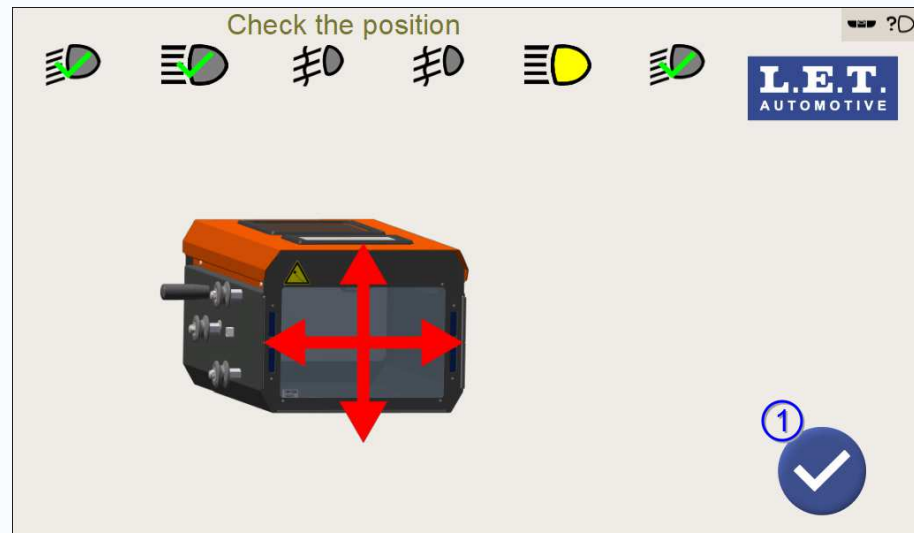

Figure 104: **Positioning** screen

Once the correct position is reached, tap on the **Validation** button 1 to proceed.

**11.** Calibrate the right *Matrix* high beam.

The right *Matrix* high beam will not be physically adjusted (e.g. with headlamp screws). The horizontal position of the left flank of one reference *LED* source of the right *Matrix* high beam is measured by the Luminoscope®.



**Attention:** Note that the horizontal position (X value) is expressed in minutes.

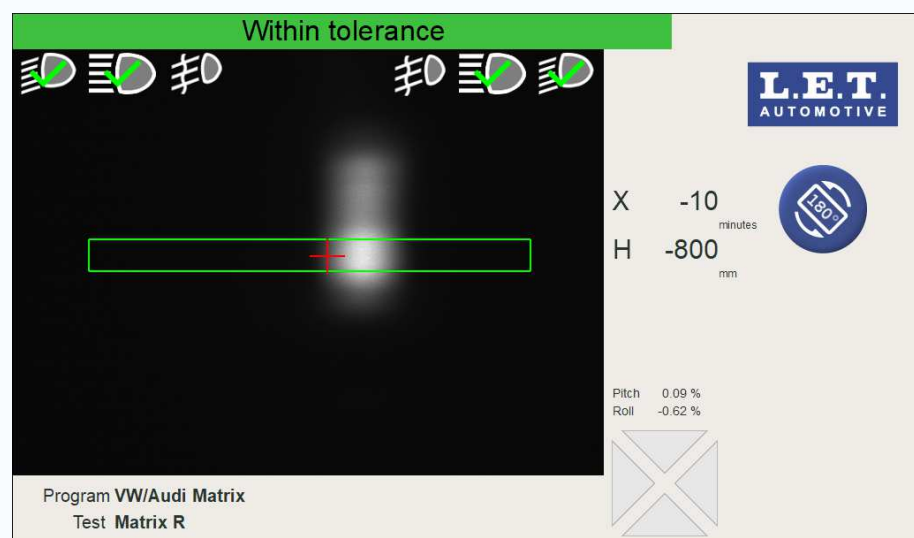

Figure 105: **Right Matrix high beam calibration**

**12.** Enter the measured position of the right *Matrix* high beam in the *vehicle diagnostic tester*.

The measured horizontal position should be stored afterwards in the *Electrical Control Unit* (ECU) of the vehicle by means of manual entry in the *vehicle diagnostic tester* that is connected to the *OBD* port of the vehicle.



**Attention:** Mind the sign of the horizontal position (X value)!

**13.** Exit the calibration mode.

Follow the specific instructions from the vehicle manufacturer on the dialog screen of the *vehicle diagnostic tester*.

**Related information**

[Alignment with the vehicle](#) (pg. 62)

### 7.3.6 VW/AUDI *Matrix 2.0* high beam sequence

This chapter explains the use of the OEM program selection for *Matrix 2.0* high beam calibration. A *Matrix 2.0* high beam, is a glare free high beam with multiple *LED* sources.



**Note:** This specific *Matrix 2.0* selection is only applicable to vehicles of the VW-Audi group which feature *Matrix 2.0* beams.



**Attention:** To perform this calibration, a *vehicle diagnostic tester* must be connected to the *On Board Diagnostic (OBD)* port of the vehicle to switch the *Matrix 2.0* high beams in a special calibration mode.

Follow the specific instructions from the vehicle manufacturer on the dialog screen of the *vehicle diagnostic tester*.



**Note:** The *Matrix 2.0* high beam will not be physically adjusted (e.g. with headlamp adjustment screws). The horizontal position of the left or right flank (depending on the vehicle side) of one reference *LED* source and the vertical position of the horizontal *cut-off line* of the *Matrix 2.0* high beam is measured by the Luminoscope®. The measured position should be stored afterwards in the *electrical control unit (ECU)* of the vehicle by means of manual entry in the *vehicle diagnostic tester* that is connected to the *OBD* port of the vehicle.

Tap on the **VW/Audi Matrix 2.0** button 1 on the **OEM program selection** screen.

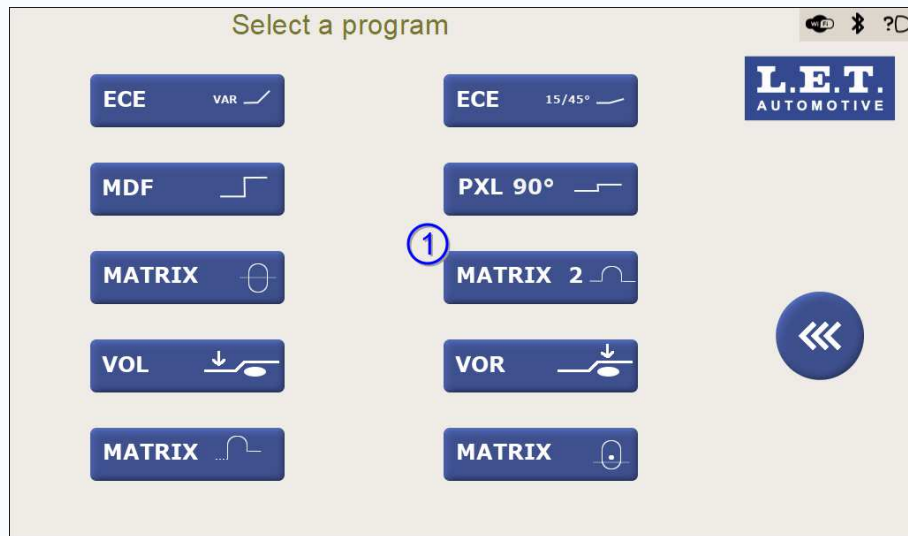

Figure 106: **OEM program selection** screen with **VW/Audi Matrix 2.0** button

The **Beam selection** screen for the **VW/Audi Matrix 2.0** program is now displayed.

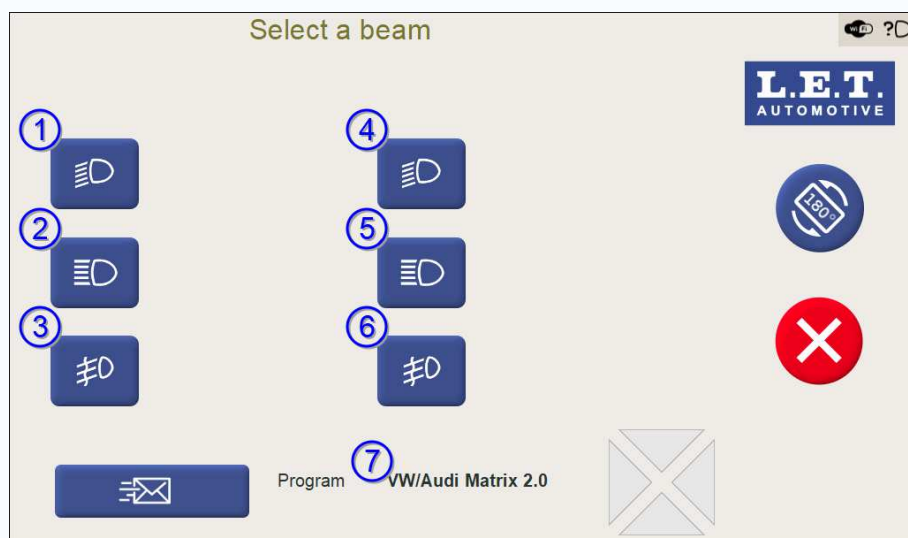

Figure 107: **Beam selection** screen for **VW/Audi Matrix 2.0** program

#	Button	Description
1	First low beam	Starts the test of the first low beam.
2	First <i>Matrix 2.0</i> high beam	Starts the test of the first <i>Matrix 2.0</i> high beam.
3	First fog beam	Starts the test of the first fog beam.
4	Second low beam	Starts the test of the second low beam.
5	Second <i>Matrix 2.0</i> high beam	Starts the test of the second <i>Matrix 2.0</i> high beam.
6	Second fog beam	Starts the test of the second fog beam.
7	Program name	<i>VW/Audi Matrix 2.0</i> program.



**Note:** Rotating the screen position affects to the position of the beam icons and beam selection buttons on the screen. The intelligence of the

Luminoscope® automatically places the beam icons and beam selection buttons on the correct side of the vehicle. For both screen orientation modes, the beam icons and beam selection buttons which are closer to the left side of the vehicle are applicable for the headlamps on the left side. Those closer to the right side of the vehicle are applicable for the headlamps on the right side.

### Related information

[Glare free high beam with multiple static LED sources \(pg. 27\)](#)

[Left / right vehicle side definition \(pg. 61\)](#)

#### 7.3.6.1 Summary of the test sequence

What follows is a summarized listing of the steps for the test sequence. Refer to the next chapter for a detailed explanation of each step.

1. Align the Luminoscope® with the vehicle.
2. Establish an *OBD* connection with the *vehicle diagnostic tester*.
3. Tap on the beam selection button corresponding with the left low beam.
4. Position the Luminoscope® in front of the left low beam.
5. Adjust the left low beam.
6. Switch the left *Matrix 2.0* high beam in a special calibration mode.
7. Tap on the beam selection button corresponding with the left *Matrix 2.0* high beam.
8. Position the Luminoscope® in front of the left *Matrix 2.0* high beam.
9. Calibrate the left *Matrix 2.0* high beam.
10. Enter the measured position of the left *Matrix 2.0* high beam in the *vehicle diagnostic tester*.
11. Tap on the beam selection button corresponding with the right low beam.
12. Position the Luminoscope® in front of the right low beam.
13. Adjust the right low beam.
14. Switch the right *Matrix 2.0* high beam in a special calibration mode.
15. Tap on the beam selection button corresponding with the right *Matrix 2.0* high beam.
16. Position the Luminoscope® in front of the right *Matrix 2.0* high beam.
17. Calibrate the right *Matrix 2.0* high beam.

18. Enter the measured position of the right *Matrix 2.0* high beam in the *vehicle diagnostic tester*.
19. Exit the calibration mode.

### 7.3.6.2 Test sequence

1. Align the Luminoscope® with the vehicle.  
Before the start of the actual test, the Luminoscope® should be properly aligned with the longitudinal axis (driving direction) of the vehicle. This is crucial in order to minimize the measurement result error in the horizontal direction. At the end of the chapter there is a link with related information on how to align the Luminoscope®.
2. Establish an *OBD* connection with the *vehicle diagnostic tester*.  
The *vehicle diagnostic tester* must be connected to the *On Board Diagnostic (OBD)* port of the vehicle to switch the *Matrix 2.0* high beam in a special calibration mode.  
Follow the specific instructions from the vehicle manufacturer on the dialog screen of the *vehicle diagnostic tester*.
3. Tap on the beam selection button corresponding with the left low beam on the **Beam selection** screen to start its calibration.



**Note:** Rotating the screen position affects to the position of the beam icons and beam selection buttons on the screen. The intelligence of the Luminoscope® automatically places the beam icons and beam selection buttons on the correct side of the vehicle. For both screen orientation modes, the beam icons and beam selection buttons which are closer to the left side of the vehicle are applicable for the headlamps on the left side. Those closer to the right side of the vehicle are applicable for the headlamps on the right side.

4. Position the Luminoscope® in front of the left low beam.  
Make use of the electronic *Position Check* system.  
Once the optimal position in front of the headlamp is achieved, the Luminoscope® proceeds automatically to the next phase in the test.
5. Adjust the left low beam.  
The left low beam should be adjusted properly.  
The following **Beam selection** screen is shown once the left low beam is properly adjusted.

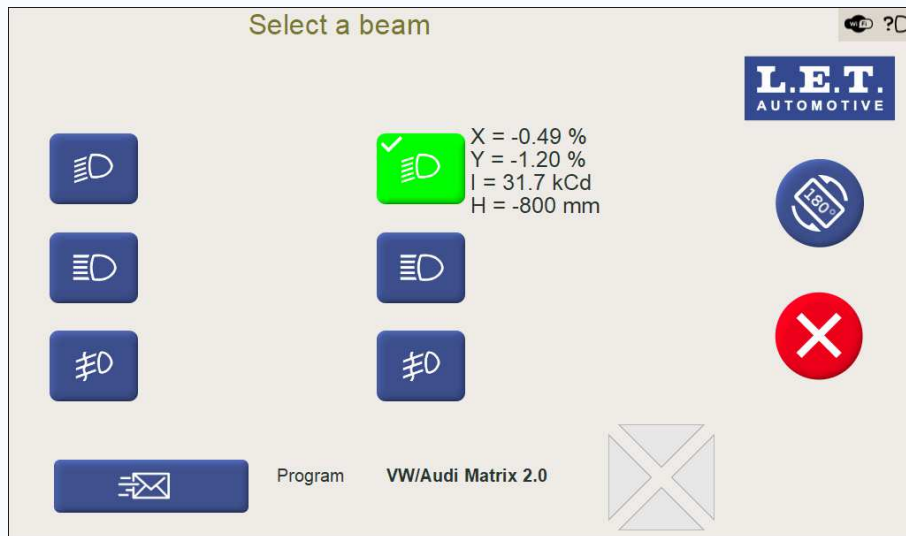

Figure 108: **Beam selection** screen with test results of the left low beam

**Note:** Rotating the screen position affects to the position of the beam icons and beam selection buttons on the screen. The intelligence of the Luminoscope® automatically places the beam icons and beam selection buttons on the correct side of the vehicle. For both screen orientation modes, the beam icons and beam selection buttons which are closer to the left side of the vehicle are applicable for the headlamps on the left side. Those closer to the right side of the vehicle are applicable for the headlamps on the right side.

6. Switch the left *Matrix 2.0* high beam in a special calibration mode.  
Follow the specific instructions from the vehicle manufacturer on the dialog screen of the *vehicle diagnostic tester*.
7. Tap on the beam selection button corresponding with the left *Matrix 2.0* high beam on the **Beam selection** screen to start its calibration.

**Note:** Rotating the screen position affects to the position of the beam icons and beam selection buttons on the screen. The intelligence of the Luminoscope® automatically places the beam icons and beam selection buttons on the correct side of the vehicle. For both screen orientation modes, the beam icons and beam selection buttons which are closer to the left side of the vehicle are applicable for the headlamps on the left side. Those closer to the right side of the vehicle are applicable for the headlamps on the right side.

8. Position the Luminoscope® in front of the left *Matrix 2.0* high beam.  
Position the Luminoscope® in front of the left *Matrix 2.0* high beam projection, in such a way the light beam shines through the centre of the lens of the Luminoscope® while observing the beam projection on the lens of the Luminoscope®.

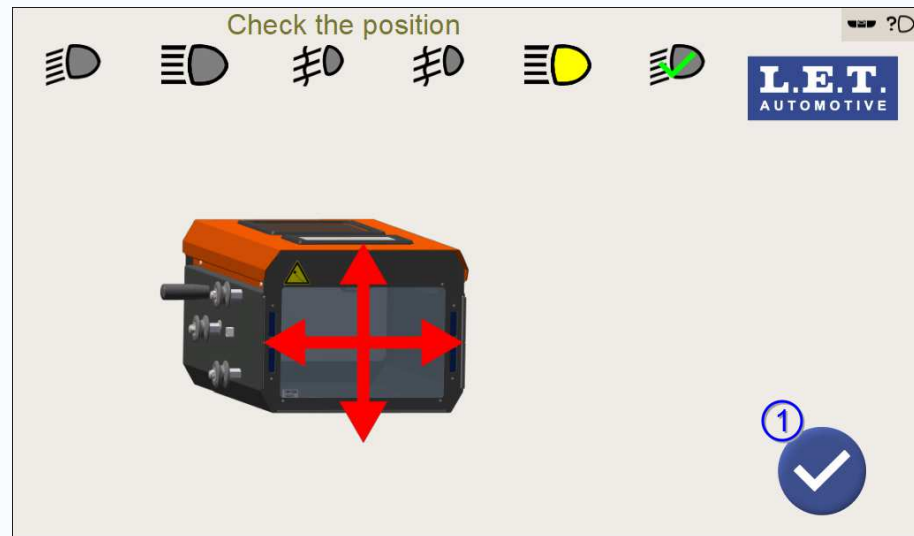

Figure 109: **Positioning** screen

Once the correct position is reached, tap on the **Validation** button 1 to proceed.

**9.** Calibrate the left *Matrix 2.0* high beam.

The left *Matrix 2.0* high beam will not be physically adjusted (e.g. with headlamp screws). The horizontal position of the right flank of one reference *LED* source and the vertical position of the horizontal *cut-off line* of the left *Matrix 2.0* high beam is measured by the Luminoscope®.



**Attention:** Note that the horizontal position (X value) and the vertical position (Y value) are expressed in minutes.

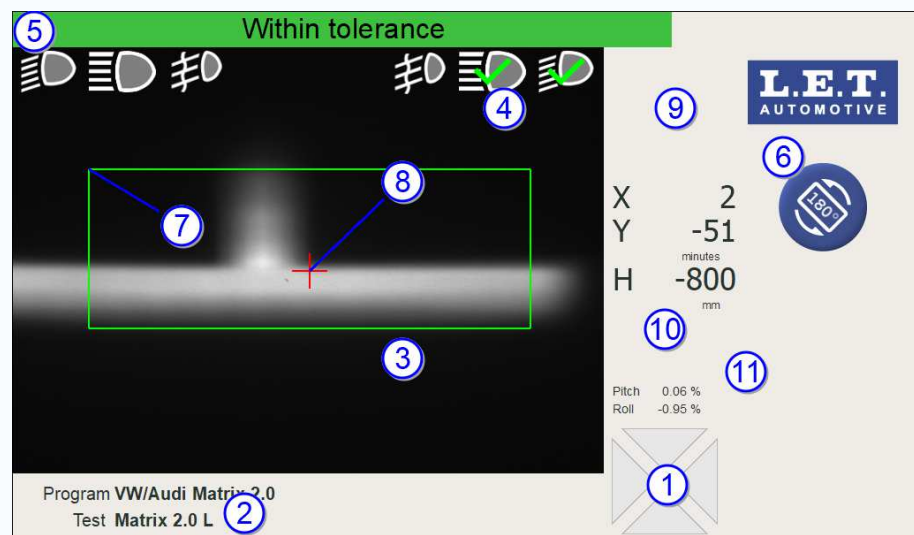

Figure 110: **Left Matrix 2.0 high beam calibration**

#	Name	Description
1	<i>Position Check Arrows</i>	Indicates the direction(s) on which the optical block should be moved to achieve the optimal position in front of the headlamp. This position can change when adjusting the headlamp.
2	Information field	Depending on the Luminoscope® configuration, some related information such as the name of the selected program (Vehicle), the name of the test (Beam), license plate, etc. will be displayed.
3	Live headlamp beam image	Real time image of the headlamp beam including overlays for tolerance zone(s), algorithm measurement position, etc.
4	First high beam icon	<p>First high beam icon indicating the status of the beam.</p> <p>The meaning of the icon depends on its shape and color:</p> <ul style="list-style-type: none"> <li>• <b>Yellow</b> mark means <b>Test in progress</b>.</li> <li>• <b>Green</b> V-sign means <b>In tolerance</b>.</li> <li>• <b>Red</b> cross means <b>Out of tolerance</b>.</li> </ul>
5	Information banner	The information banner shows different status messages such as: <b>Test in progress</b> , <b>Within tolerance</b> , <b>Out of tolerance</b> , etc. Status, error or warning messages can also be displayed over there.
6	<b>Rotate screen</b> button	Rotate the screen position.
7	Audit tolerance zone	The <i>audit tolerance zone</i> allows the operator to check if the headlamp is within the audit tolerances that are applicable in a government inspection station.
8	Algorithm measurement position	The algorithm overlay (red cross) represents the algorithm measurement position on the headlamp beam image. In case of an aiming cycle, the red cross position should be aimed towards the centre of the aiming tolerance zone. In case of an audit cycle, the red cross position is evaluated. The actual position is displayed on the headlamp measurement result field.
9	Beam direction arrows	<p>The beam direction arrows indicate the direction(s) in which the headlamp should be moved to reach the target position inside the tolerance zone.</p> <p>The colour of the arrows indicates the live status of the aiming:</p> <ul style="list-style-type: none"> <li>• <b>Green</b> means the result is <i>inside</i> the tolerance zone.</li> <li>• <b>Yellow</b> means the result is <i>close</i> to the tolerance zone.</li> <li>• <b>Red</b> means the result is <i>far away</i> from the tolerance zone.</li> </ul>

#	Name	Description
10	Headlamp measurement results field	Depending on the chosen algorithm and Luminoscope® configuration, headlamp measurement results such as horizontal beam position (X), vertical beam position (Y), etc. are displayed here.
11	ESL (Electronic Spirit Level) module angles	Measured Pitch and Roll angle of the ESL (Electronic Spirit Level) module, if applicable.

10. Enter the measured position of the left *Matrix 2.0* high beam in the *vehicle diagnostic tester*.

The measured horizontal and vertical positions should be stored afterwards in the *Electrical Control Unit* (ECU) of the vehicle by means of manual entry in the *vehicle diagnostic tester* that is connected to the *OBD* port of the vehicle.



**Attention:** Mind the sign of the horizontal position (X value) and the vertical position (Y value)!

11. Tap on the beam selection button corresponding with the right low beam on the **Beam selection** screen to start its calibration.



**Note:** Rotating the screen position affects to the position of the beam icons and beam selection buttons on the screen. The intelligence of the Luminoscope® automatically places the beam icons and beam selection buttons on the correct side of the vehicle. For both screen orientation modes, the beam icons and beam selection buttons which are closer to the left side of the vehicle are applicable for the headlamps on the left side. Those closer to the right side of the vehicle are applicable for the headlamps on the right side.

12. Position the Luminoscope® in front of the right low beam.

Make use of the electronic *Position Check* system.

Once the optimal position in front of the headlamp is achieved, the Luminoscope® proceeds automatically to the next phase in the test.

13. Adjust the right low beam.

The right low beam should be adjusted properly.

14. Switch the right *Matrix 2.0* high beam in a special calibration mode.

Follow the specific instructions from the vehicle manufacturer on the dialog screen of the *vehicle diagnostic tester*.

15. Tap on the beam selection button corresponding with the right *Matrix 2.0* high beam on the **Beam selection** screen to start its calibration.



**Note:** Rotating the screen position affects to the position of the beam icons and beam selection buttons on the screen. The intelligence of

the Luminoscope® automatically places the beam icons and beam selection buttons on the correct side of the vehicle. For both screen orientation modes, the beam icons and beam selection buttons which are closer to the left side of the vehicle are applicable for the headlamps on the left side. Those closer to the right side of the vehicle are applicable for the headlamps on the right side.

**16.** Position the Luminoscope® in front of the right *Matrix 2.0* high beam.

Position the Luminoscope® in front of the right *Matrix 2.0* high beam projection, in such a way the light beam shines through the centre of the lens of the Luminoscope® while observing the beam projection on the lens of the Luminoscope®.

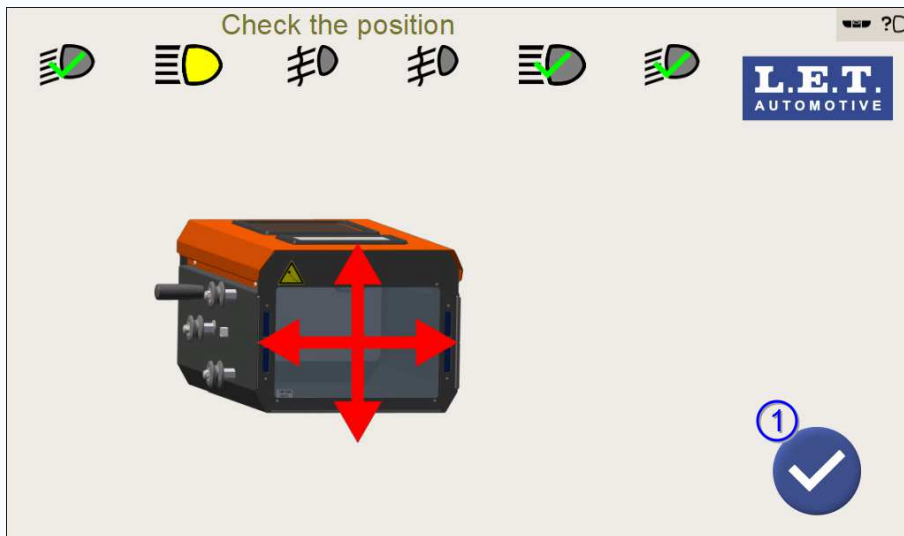

Figure 111: *Positioning* screen

Once the correct position is reached, tap on the **Validation** button 1 to proceed.

**17.** Calibrate the right *Matrix 2.0* high beam.

The right *Matrix 2.0* high beam will not be physically adjusted (e.g. with headlamp screws). The horizontal position of the left flank of one reference *LED* source and the vertical position of the horizontal *cut-off line* of the right *Matrix 2.0* high beam is measured by the Luminoscope®.



**Attention:** Note that the horizontal position (X value) and the vertical position (Y value) are expressed in minutes.

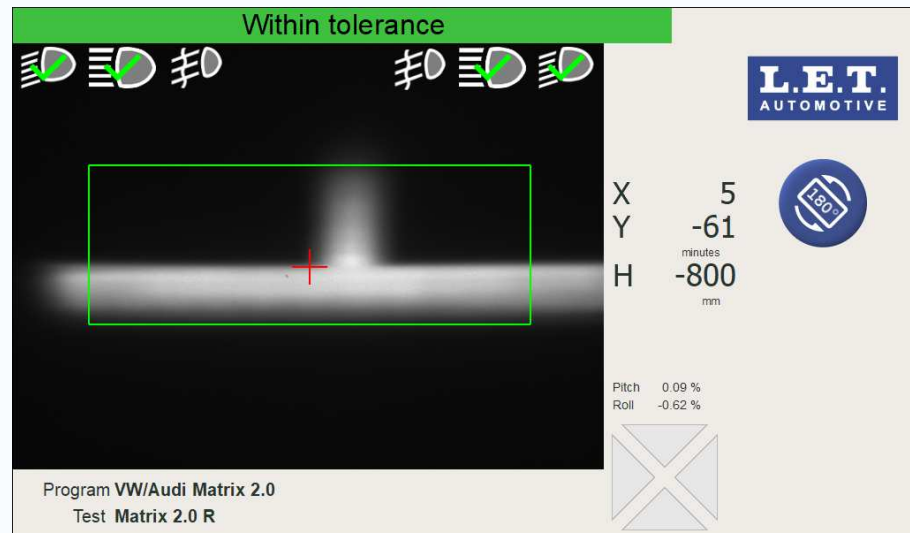

Figure 112: Right Matrix 2.0 high beam calibration

18. Enter the measured position of the right *Matrix 2.0* high beam in the *vehicle diagnostic tester*.

The measured horizontal and vertical positions should be stored afterwards in the *Electrical Control Unit* (ECU) of the vehicle by means of manual entry in the *vehicle diagnostic tester* that is connected to the *OBD* port of the vehicle.



**Attention:** Mind the sign of the horizontal position (X value) and the vertical position (Y value)!

19. Exit the calibration mode.

Follow the specific instructions from the vehicle manufacturer on the dialog screen of the *vehicle diagnostic tester*.

#### Related tasks

[Positioning in front of the headlamp](#) (pg. 85)

#### Related information

[Alignment with the vehicle](#) (pg. 62)

### 7.3.7 SKODA *Matrix* high beam sequence

This chapter explains the use of the OEM program selection for *Matrix* high beam calibration. A *Matrix* high beam, is a glare free high beam with multiple *LED* sources.



**Note:** This specific *Matrix* selection is only applicable to vehicles of the *Skoda* group (in particular the *Skoda Octavia*) which feature *Matrix* beams.



**Attention:** To perform this calibration, a *vehicle diagnostic tester* must be connected to the *On Board Diagnostic (OBD)* port of the vehicle to switch the low beams and the *Matrix* high beams in a special calibration mode.

Follow the specific instructions from the vehicle manufacturer on the dialog screen of the *vehicle diagnostic tester*.



**Note:** The low beam and *Matrix* high beam have to be physically adjusted with their corresponding headlamp adjustment screws.

Tap on the **Skoda Matrix** button 1 on the **OEM program selection** screen.

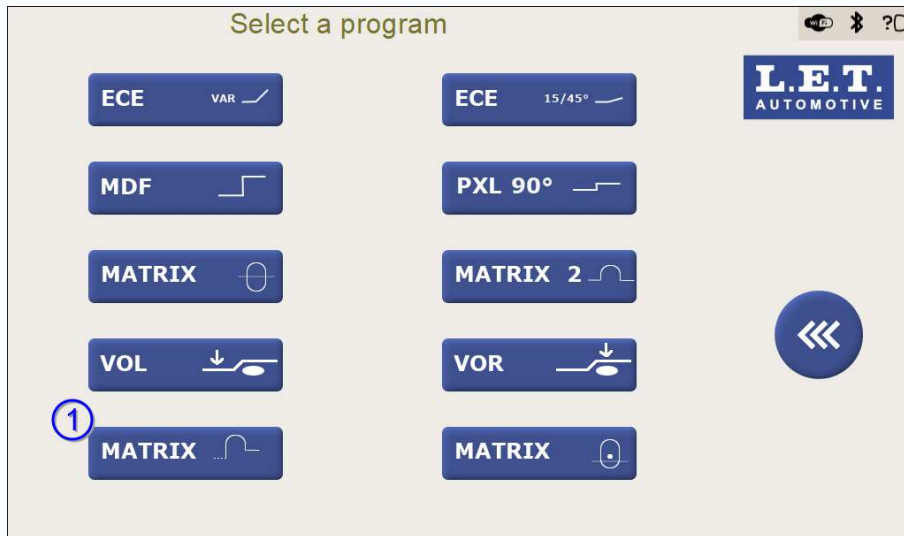

Figure 113: **OEM program selection** screen with **Skoda Matrix** button

The **Beam selection** screen for the *Skoda Matrix* program is now displayed.

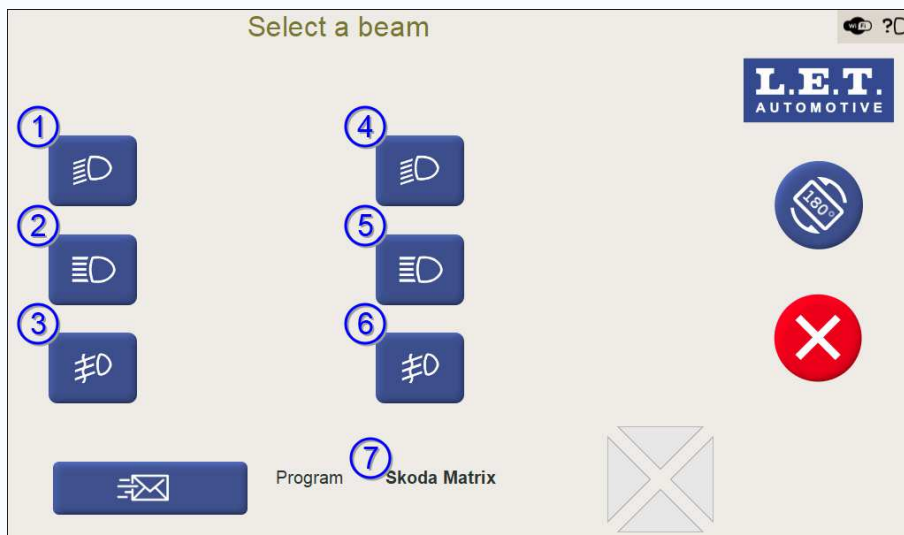

Figure 114: **Beam selection** screen for *Skoda Matrix* program

#	Button	Description
1	First low beam	Starts the test of the first low beam.
2	First <i>Matrix</i> high beam	Starts the test of the first <i>Matrix</i> high beam.

#	Button	Description
3	First fog beam	Starts the test of the first fog beam.
4	Second low beam	Starts the test of the second low beam.
5	Second <i>Matrix</i> high beam	Starts the test of the second <i>Matrix</i> high beam.
6	Second fog beam	Starts the test of the second fog beam.
7	Program name	<i>Skoda Matrix</i> program.



**Note:** Rotating the screen position affects to the position of the beam icons and beam selection buttons on the screen. The intelligence of the Luminoscope® automatically places the beam icons and beam selection buttons on the correct side of the vehicle. For both screen orientation modes, the beam icons and beam selection buttons which are closer to the left side of the vehicle are applicable for the headlamps on the left side. Those closer to the right side of the vehicle are applicable for the headlamps on the right side.

#### Related information

[Glare free high beam with multiple static LED sources](#) (pg. 27)

[Left / right vehicle side definition](#) (pg. 61)

#### 7.3.7.1 Summary of the test sequence

What follows is a summarized listing of the steps for the test sequence. Refer to the next chapter for a detailed explanation of each step.

1. Align the Luminoscope® with the vehicle.
2. Establish an *OBD* connection with the *vehicle diagnostic tester*.
3. Switch the low beams and *Matrix* high beams in a special calibration mode.
4. Tap on the beam selection button corresponding with the left low beam.
5. Position the Luminoscope® in front of the left low beam.
6. Adjust the left low beam.
7. Tap on the beam selection button corresponding with the left *Matrix* high beam.
8. Position the Luminoscope® in front of the left *Matrix* high beam.
9. Adjust the left *Matrix* high beam.
10. Tap on the beam selection button corresponding with the right low beam.
11. Position the Luminoscope® in front of the right low beam.

12. Adjust the right low beam.
13. Tap on the beam selection button corresponding with the right *Matrix* high beam.
14. Position the Luminoscope® in front of the right *Matrix* high beam.
15. Adjust the right *Matrix* high beam.
16. Exit the calibration mode.

### 7.3.7.2 Test sequence

1. Align the Luminoscope® with the vehicle.  
Before the start of the actual test, the Luminoscope® should be properly aligned with the longitudinal axis (driving direction) of the vehicle. This is crucial in order to minimize the measurement result error in the horizontal direction. At the end of the chapter there is a link with related information on how to align the Luminoscope®.
2. Establish an *OBD* connection with the *vehicle diagnostic tester*.  
The *vehicle diagnostic tester* must be connected to the *On Board Diagnostic (OBD)* port of the vehicle to switch the low beams and *Matrix* high beams in a special calibration mode.  
Follow the specific instructions from the vehicle manufacturer on the dialog screen of the *vehicle diagnostic tester*.
3. Switch the low beams and the *Matrix* high beams in a special calibration mode.  
Follow the specific instructions from the vehicle manufacturer on the dialog screen of the *vehicle diagnostic tester*.
4. Tap on the beam selection button corresponding with the left low beam on the **Beam selection** screen to start its calibration.



**Note:** Rotating the screen position affects to the position of the beam icons and beam selection buttons on the screen. The intelligence of the Luminoscope® automatically places the beam icons and beam selection buttons on the correct side of the vehicle. For both screen orientation modes, the beam icons and beam selection buttons which are closer to the left side of the vehicle are applicable for the headlamps on the left side. Those closer to the right side of the vehicle are applicable for the headlamps on the right side.

5. Position the Luminoscope® in front of the left low beam.  
Position the lens of the Luminoscope® in front of the headlamp lens closest to the outer edge of the vehicle, in such a way that the light shines through the centre of the lens of the Luminoscope® while observing the beam projection on the lens of the Luminoscope®.



**Note:** The low beam projection on the white projection screen inside the optical block should show a complete horizontal cut-off line with

no light above the cut-off line. It is strongly recommended to cover the other lens of the headlamp during the adjustment of the low beam to avoid that any light of that source is projected above the horizontal cut-off line of the low beam

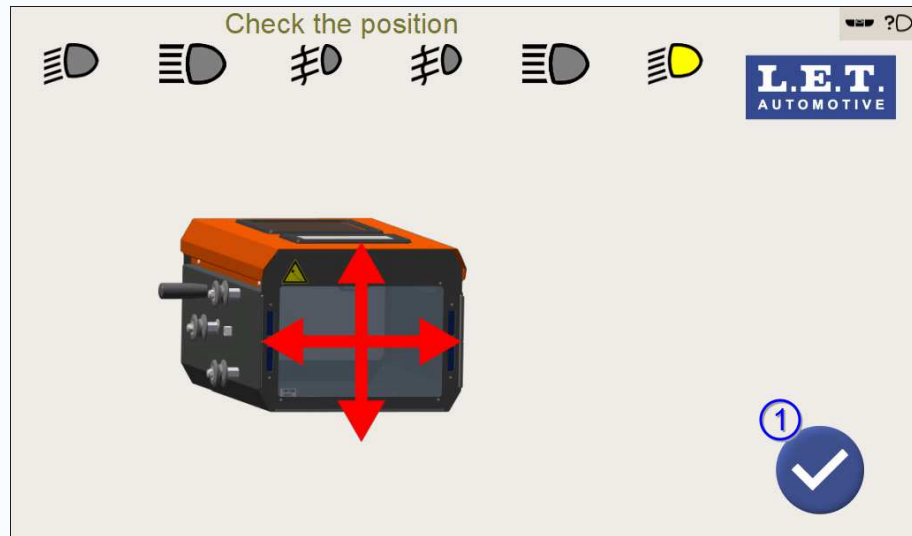

Figure 115: **Positioning** screen while positioning in front of the left low beam

Once the correct position is reached, tap on the **Validation** button 1 to proceed.

**6.** Adjust the left low beam.

The low beam should be adjusted only in vertical direction (Y-direction). The vertical cut-off position should be set to -1,25%.



**Attention:** Do not use the adjusting screw for horizontal direction (X-direction) while adjusting the low beams!

Follow the specific instructions from the vehicle manufacturer in order to physically adjust the vertical setting of the headlamp (Y-direction) with the corresponding adjusting screw.

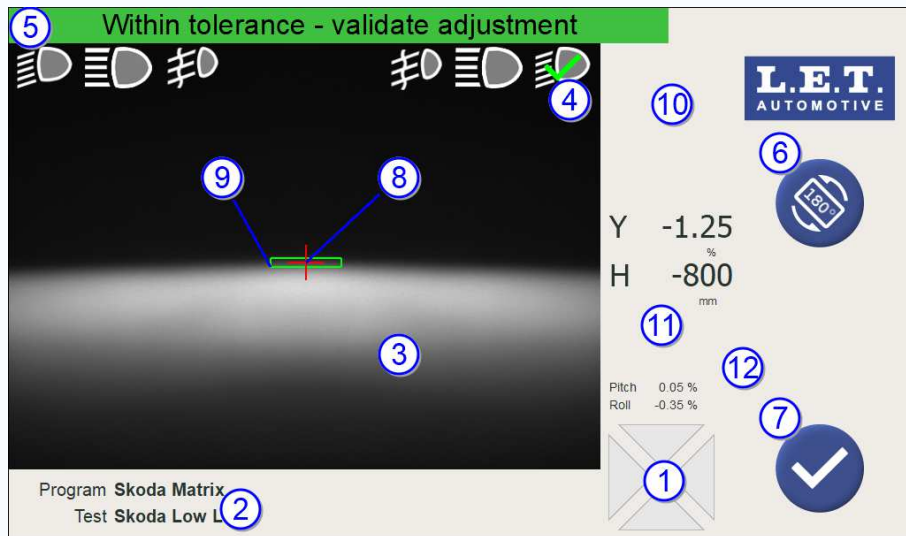

Figure 116: Left low beam adjustment

#	Name	Description
1	<i>Position Check Arrows</i>	Indicates the direction(s) on which the optical block should be moved to achieve the optimal position in front of the headlamp. This position can change when adjusting the headlamp.
2	Information field	Depending on the Luminoscope® configuration, some related information such as the name of the selected program (Vehicle), the name of the test (Beam), license plate, etc. will be displayed.
3	Live headlamp beam image	Real time image of the headlamp beam including overlays for tolerance zone(s), algorithm measurement position, etc.
4	First low beam icon	First low beam icon indicating the status of the beam.  The meaning of the icon depends on its shape and color: <ul style="list-style-type: none"> <li>• <b>Yellow</b> mark means <b>Test in progress</b>.</li> <li>• <b>Green</b> V-sign means <b>In tolerance</b>.</li> <li>• <b>Red</b> cross means <b>Out of tolerance</b>.</li> </ul>
5	Information banner	The information banner shows different status messages such as: <b>Test in progress</b> , <b>Within tolerance</b> , <b>Out of tolerance</b> , etc. Status, error or warning messages can also be displayed over there.
6	<b>Rotate screen</b> button	Rotate the screen position.
7	<b>Validation</b> button	If the <i>live validation</i> function is activated, tapping on this button will store the beam measurement result. The result is unconditionally stored whether the algorithm measurement position is <i>Within tolerance</i> or <i>Out of tolerance</i> .

#	Name	Description
8	Algorithm measurement position	The algorithm overlay (red cross) represents the algorithm measurement position on the headlamp beam image. In case of an aiming cycle, the red cross position should be aimed towards the centre of the aiming tolerance zone. In case of an audit cycle, the red cross position is evaluated. The actual position is displayed on the headlamp measurement result field.
9	Aiming tolerance zone	The aiming tolerance zone allows the operator to adjust the headlamp correctly. Note that the aiming tolerance zone should always be smaller than the audit tolerance zone. This is to ensure that a correctly aimed headlamp at a workshop ( <i>using the smaller aiming tolerance zone</i> ) will pass the test in a government inspection station ( <i>using the larger audit tolerance zone</i> ).
10	Beam direction arrows	The beam direction arrows indicate the direction(s) in which the headlamp should be moved to reach the target position inside the tolerance zone.  The colour of the arrows indicates the live status of the aiming: <ul style="list-style-type: none"> <li>• <b>Green</b> means the result is <i>inside</i> the tolerance zone.</li> <li>• <b>Yellow</b> means the result is <i>close</i> to the tolerance zone.</li> <li>• <b>Red</b> means the result is <i>far away</i> from the tolerance zone.</li> </ul>
11	Headlamp measurement results field	Depending on the chosen algorithm and Luminoscope® configuration, headlamp measurement results such as horizontal beam position (X), vertical beam position (Y), etc. are displayed here.
12	ESL (Electronic Spirit Level) module angles	Measured Pitch and Roll angle of the ESL (Electronic Spirit Level) module, if applicable.

The following **Beam selection** screen is shown once the left low beam is properly adjusted.

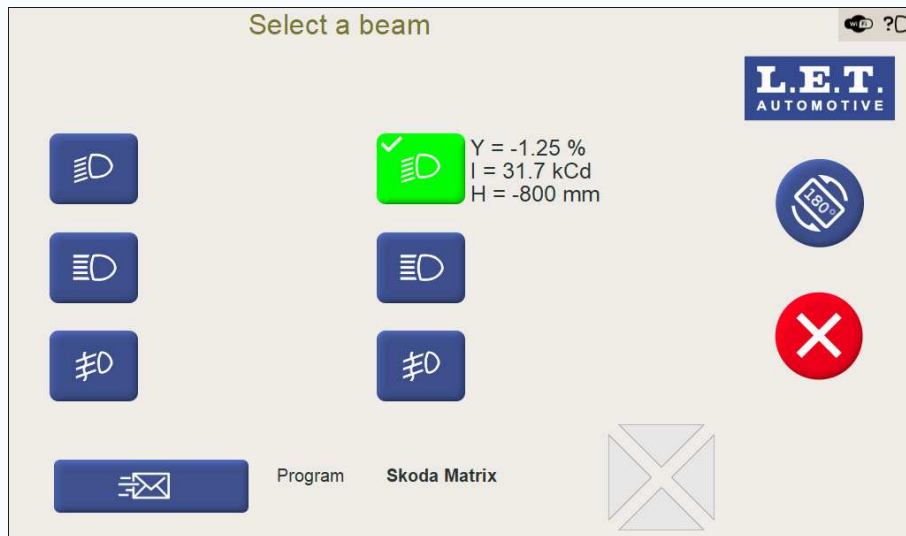

Figure 117: **Beam selection** screen with test results of the left low beam

**Note:** Rotating the screen position affects to the position of the beam icons and beam selection buttons on the screen. The intelligence of the Luminoscope® automatically places the beam icons and beam selection buttons on the correct side of the vehicle. For both screen orientation modes, the beam icons and beam selection buttons which are closer to the left side of the vehicle are applicable for the headlamps on the left side. Those closer to the right side of the vehicle are applicable for the headlamps on the right side.

7. Tap on the beam selection button corresponding with the left *Matrix* high beam on the **Beam selection** screen to start its calibration.

**Note:** Rotating the screen position affects to the position of the beam icons and beam selection buttons on the screen. The intelligence of the Luminoscope® automatically places the beam icons and beam selection buttons on the correct side of the vehicle. For both screen orientation modes, the beam icons and beam selection buttons which are closer to the left side of the vehicle are applicable for the headlamps on the left side. Those closer to the right side of the vehicle are applicable for the headlamps on the right side.

8. Position the Luminoscope® in front of the left *Matrix* high beam.

Position the lens of the Luminoscope® in front of the headlamp lens closest to the centre of the vehicle, in such a way the light beam shines through the centre of the lens of the Luminoscope® while observing the beam projection on the lens of the Luminoscope®.

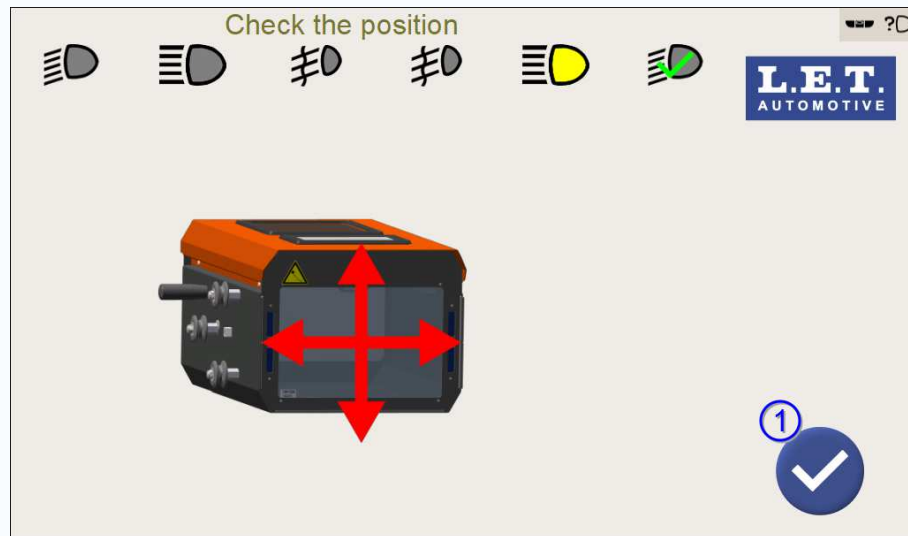

Figure 118: **Positioning** screen while positioning in front of the left Matrix high beam

Once the correct position is reached, tap on the **Validation** button 1 to proceed.

**9.** Adjust the left *Matrix* high beam.

The *Matrix* high beam should be adjusted only in horizontal direction (X-direction). The horizontal position of the left flank of the reference source should be set to 0,70%.



**Attention:** Do not use the adjustment screw for vertical direction (Y-direction) while adjusting the *Matrix* high beams!

Follow the specific instructions from the vehicle manufacturer in order to physically adjust the correct horizontal setting of the headlamp (X-direction) with the corresponding adjusting screw.

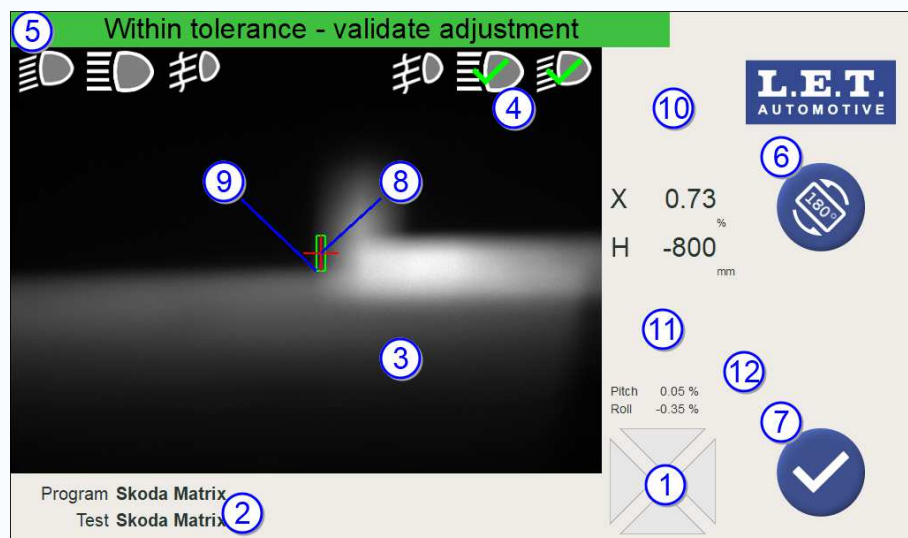

Figure 119: Left Matrix high beam adjustment

#	Name	Description
1	<i>Position Check Arrows</i>	Indicates the direction(s) on which the optical block should be moved to achieve the optimal position in front of the headlamp. This position can change when adjusting the headlamp.
2	Information field	Depending on the Luminoscope® configuration, some related information such as the name of the selected program (Vehicle), the name of the test (Beam), license plate, etc. will be displayed.
3	Live headlamp beam image	Real time image of the headlamp beam including overlays for tolerance zone(s), algorithm measurement position, etc.
4	First high beam icon	<p>First high beam icon indicating the status of the beam.</p> <p>The meaning of the icon depends on its shape and color:</p> <ul style="list-style-type: none"> <li>• <b>Yellow</b> mark means <b>Test in progress</b>.</li> <li>• <b>Green</b> V-sign means <b>In tolerance</b>.</li> <li>• <b>Red</b> cross means <b>Out of tolerance</b>.</li> </ul>
5	Information banner	The information banner shows different status messages such as: <b>Test in progress</b> , <b>Within tolerance</b> , <b>Out of tolerance</b> , etc. Status, error or warning messages can also be displayed over there.
6	<b>Rotate screen</b> button	Rotate the screen position.
7	<b>Validation</b> button	If the <i>live validation</i> function is activated, tapping on this button will store the beam measurement result. The result is unconditionally stored whether the algorithm measurement position is <i>Within tolerance</i> or <i>Out of tolerance</i> .
8	Algorithm measurement position	The algorithm overlay (red cross) represents the algorithm measurement position on the headlamp beam image. In case of an aiming cycle, the red cross position should be aimed towards the centre of the aiming tolerance zone. In case of an audit cycle, the red cross position is evaluated. The actual position is displayed on the headlamp measurement result field.
9	Aiming tolerance zone	The aiming tolerance zone allows the operator to adjust the headlamp correctly. Note that the aiming tolerance zone should always be smaller than the audit tolerance zone. This is to ensure that a correctly aimed headlamp at a workshop ( <i>using the smaller aiming tolerance zone</i> ) will pass the test in a government inspection station ( <i>using the larger audit tolerance zone</i> ).

#	Name	Description
10	Beam direction arrows	<p>The beam direction arrows indicate the direction(s) in which the headlamp should be moved to reach the target position inside the tolerance zone.</p> <p>The colour of the arrows indicates the live status of the aiming:</p> <ul style="list-style-type: none"> <li>• <b>Green</b> means the result is <i>inside</i> the tolerance zone.</li> <li>• <b>Yellow</b> means the result is <i>close</i> to the tolerance zone.</li> <li>• <b>Red</b> means the result is <i>far away</i> from the tolerance zone.</li> </ul>
11	Headlamp measurement results field	Depending on the chosen algorithm and Luminoscope® configuration, headlamp measurement results such as horizontal beam position (X), vertical beam position (Y), etc. are displayed here.
12	ESL (Electronic Spirit Level) module angles	Measured Pitch and Roll angle of the ESL (Electronic Spirit Level) module, if applicable.

The following **Beam selection** screen is shown once the left *Matrix* high beam is properly adjusted.

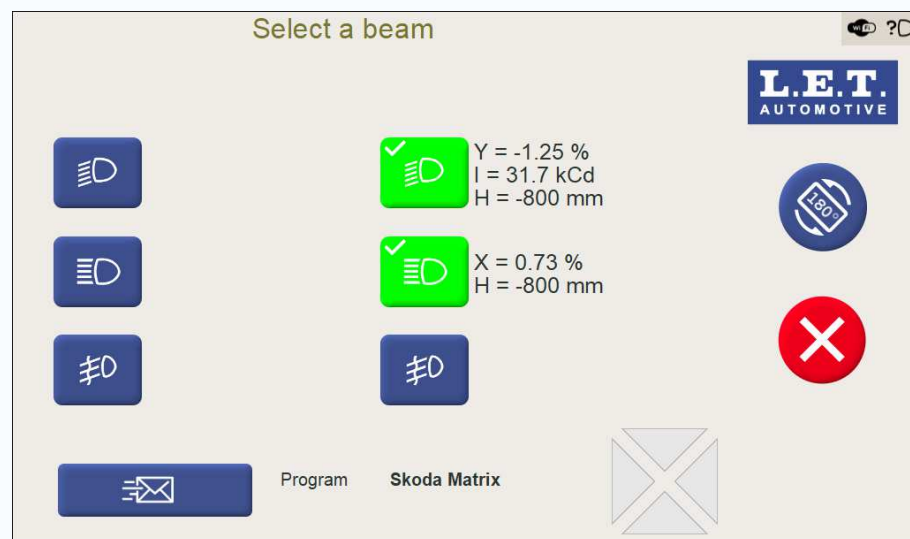

Figure 120: **Beam selection** screen with test results of the left *Matrix* high beam

**Note:** Rotating the screen position affects to the position of the beam icons and beam selection buttons on the screen. The intelligence of the Luminoscope® automatically places the beam icons and beam selection buttons on the correct side of the vehicle. For both screen orientation modes, the beam icons and beam selection buttons which are closer to the left side of the vehicle are applicable for the headlamps on the left side. Those closer to the right side of the vehicle are applicable for the headlamps on the right side.

10. Tap on the beam selection button corresponding with the right low beam on the **Beam selection** screen to start its calibration.

**i** **Note:** Rotating the screen position affects to the position of the beam icons and beam selection buttons on the screen. The intelligence of the Luminoscope® automatically places the beam icons and beam selection buttons on the correct side of the vehicle. For both screen orientation modes, the beam icons and beam selection buttons which are closer to the left side of the vehicle are applicable for the headlamps on the left side. Those closer to the right side of the vehicle are applicable for the headlamps on the right side.

11. Position the Luminoscope® in front of the right low beam.

Position the lens of the Luminoscope® in front of the headlamp lens closest to the outer edge of the vehicle, in such a way that the light shines through the centre of the lens of the Luminoscope® while observing the beam projection on the lens of the Luminoscope®.

**i** **Note:** The low beam projection on the white projection screen inside the optical block should show a complete horizontal cut-off line with no light above the cut-off line. It is strongly recommended to cover the other lens of the headlamp during the adjustment of the low beam to avoid that any light of that source is projected above the horizontal cut-off line of the low beam

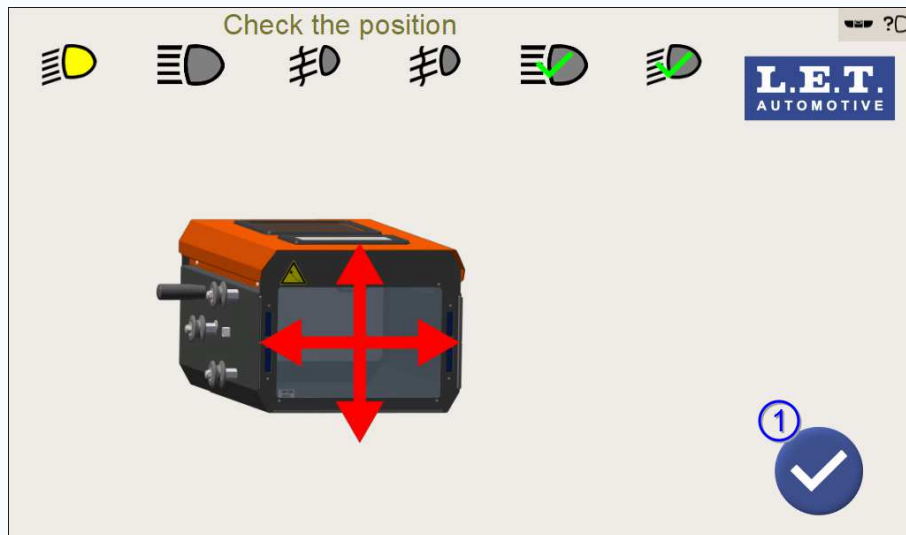

Figure 121: **Positioning** screen while positioning in front of the right low beam

Once the correct position is reached, tap on the **Validation** button 1 to proceed.

12. Adjust the right low beam.

The low beam should be adjusted only in vertical direction (Y-direction). The vertical cut-off position should be set to -1,25%.

**!** **Attention:** Do not use the adjusting screw for horizontal direction (X-direction) while adjusting the low beams!

Follow the specific instructions from the vehicle manufacturer in order to physically adjust the vertical setting of the headlamp (Y-direction) with the corresponding adjusting screw.

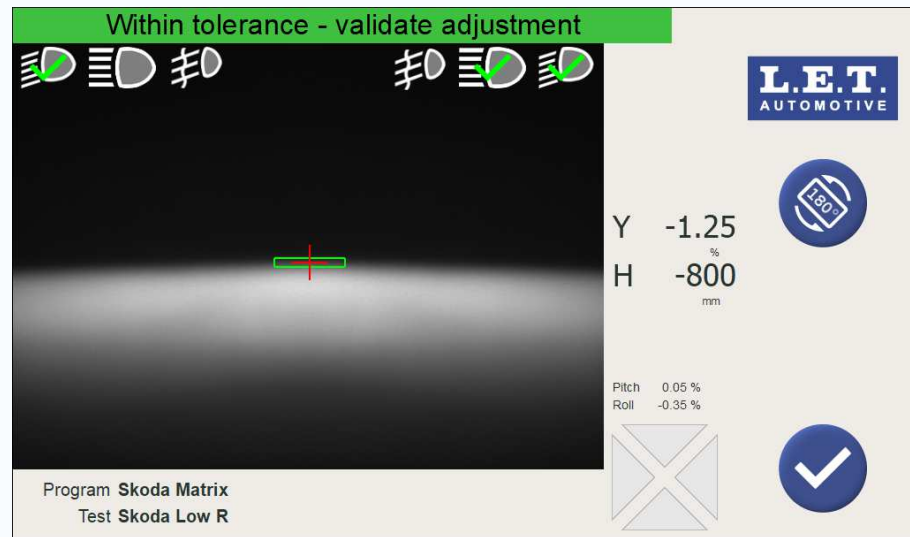

Figure 122: Right low beam adjustment

The following **Beam selection** screen is shown once the right low beam is properly adjusted.

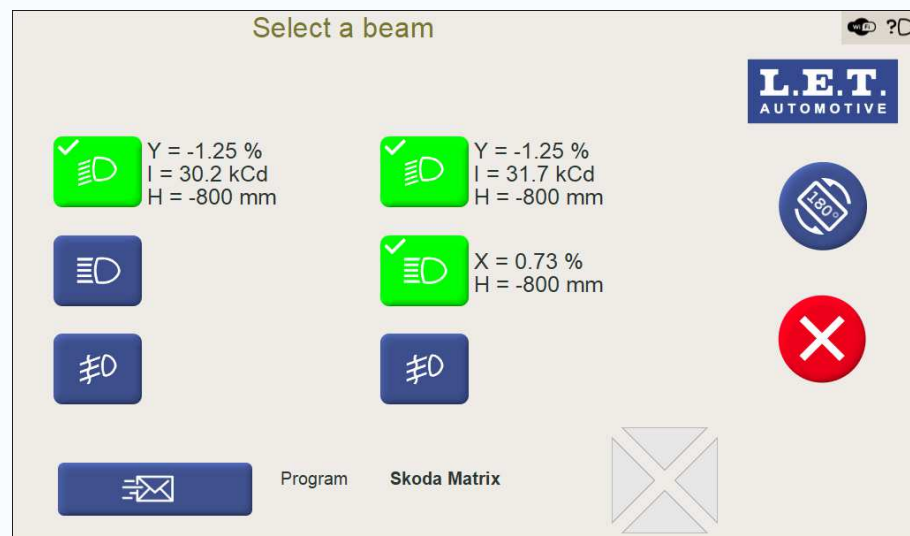

Figure 123: **Beam selection** screen with test results of the right low beam



**Note:** Rotating the screen position affects to the position of the beam icons and beam selection buttons on the screen. The intelligence of the Luminoscope® automatically places the beam icons and beam selection buttons on the correct side of the vehicle. For both screen orientation modes, the beam icons and beam selection buttons which are closer to the left side of the vehicle are applicable for the

headlamps on the left side. Those closer to the right side of the vehicle are applicable for the headlamps on the right side.

13. Tap on the beam selection button corresponding with the right *Matrix* high beam on the **Beam selection** screen to start its calibration.



**Note:** Rotating the screen position affects to the position of the beam icons and beam selection buttons on the screen. The intelligence of the Luminoscope® automatically places the beam icons and beam selection buttons on the correct side of the vehicle. For both screen orientation modes, the beam icons and beam selection buttons which are closer to the left side of the vehicle are applicable for the headlamps on the left side. Those closer to the right side of the vehicle are applicable for the headlamps on the right side.

14. Position the Luminoscope® in front of the right *Matrix* high beam.

Position the lens of the Luminoscope® in front of the headlamp lens closest to the centre of the vehicle, in such a way the light beam shines through the centre of the lens of the Luminoscope® while observing the beam projection on the lens of the Luminoscope®.

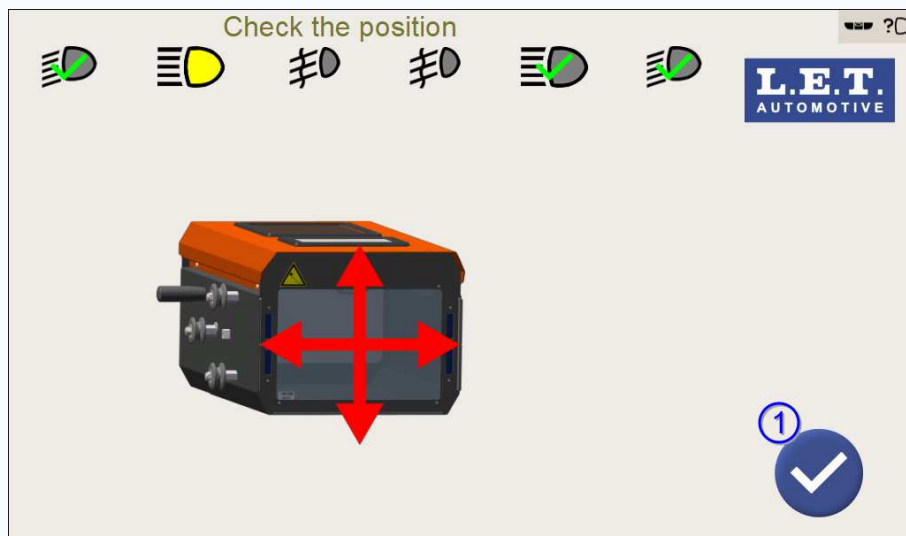

Figure 124: **Positioning** screen while positioning in front of the right *Matrix* high beam

Once the correct position is reached, tap on the **Validation** button 1 to proceed.

15. Adjust the right *Matrix* high beam.

The *Matrix* high beam should be adjusted only in horizontal direction (X-direction). The horizontal position of the left flank of the reference source should be set to 0,70%.



**Attention:** Do not use the adjustment screw for vertical direction (Y-direction) while adjusting the *Matrix* high beams!

Follow the specific instructions from the vehicle manufacturer in order to physically adjust the correct horizontal setting of the headlamp (X-direction) with the corresponding adjusting screw.

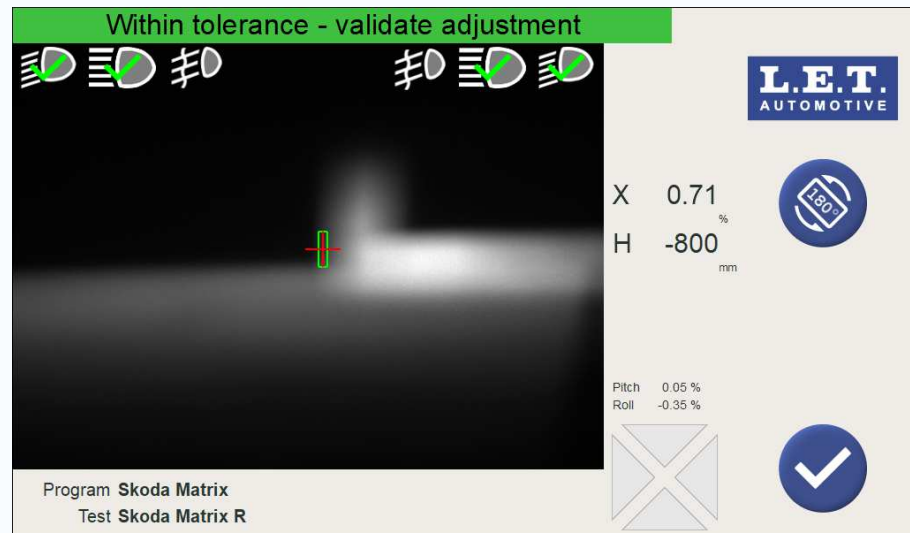

Figure 125: Right Matrix high beam adjustment

The following **Beam selection** screen is shown once the right *Matrix* high beam is properly adjusted.

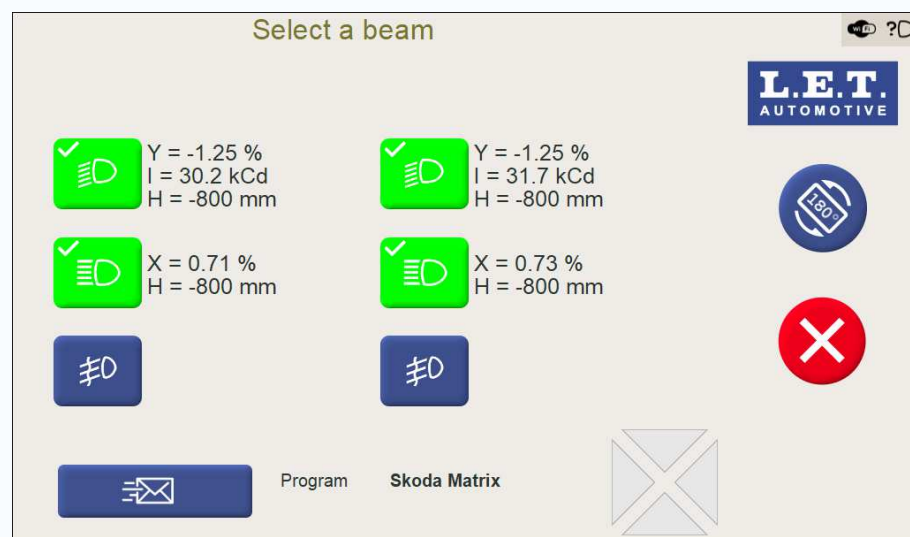

Figure 126: **Beam selection** screen with test results of the right *Matrix* high beam



**Note:** Rotating the screen position affects to the position of the beam icons and beam selection buttons on the screen. The intelligence of the Luminoscope® automatically places the beam icons and beam selection buttons on the correct side of the vehicle. For both screen orientation modes, the beam icons and beam selection buttons which are closer to the left side of the vehicle are applicable for the headlamps on the left side. Those closer to the right side of the vehicle are applicable for the headlamps on the right side.

16. Exit the calibration mode.

Follow the specific instructions from the vehicle manufacturer on the dialog screen of the *vehicle diagnostic tester*.

#### Related information

[Alignment with the vehicle](#) (pg. 62)

### 7.3.8 Renault *Matrix* high beam sequence

This chapter explains the use of the OEM program selection for *Matrix* high beam calibration. A *Matrix* high beam is a glare free high beam with multiple *LED* sources.

**Note:** This specific *Matrix* selection is only applicable to vehicles of the *Renault* group which feature *Matrix* beams.

**Attention:** To perform this calibration, a *vehicle diagnostic tester* must be connected to the *On Board Diagnostic (OBD)* port of the vehicle to switch the *Matrix* high beams in a special calibration mode.

Follow the specific instructions from the vehicle manufacturer on the dialog screen of the *vehicle diagnostic tester*.

**Note:** The low and *Matrix* high beams have to be physically adjusted with their corresponding headlamp adjustment screws.

Tap on the **Renault Matrix** button 1 on the **OEM program selection** screen.

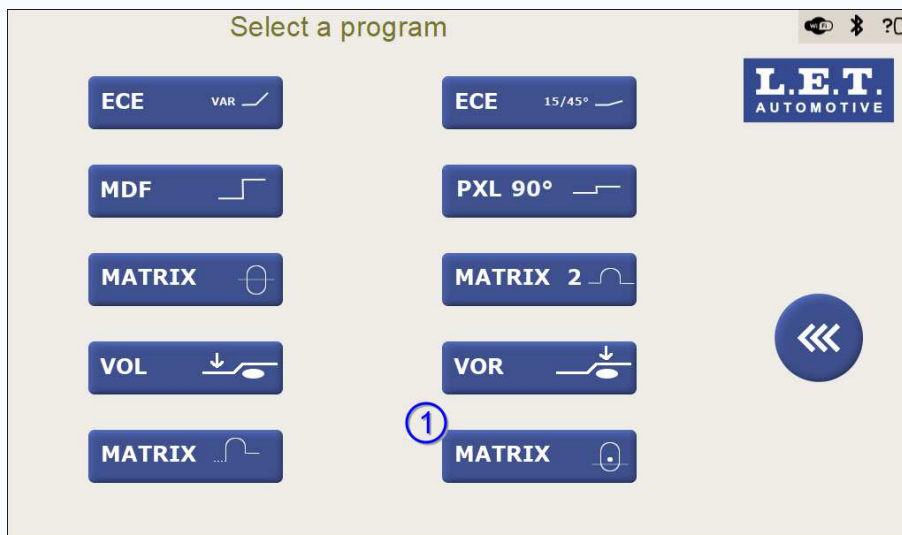

Figure 127: **OEM program selection** screen with **Renault Matrix** button

The **Beam selection** screen for the *Renault Matrix* program is now displayed.

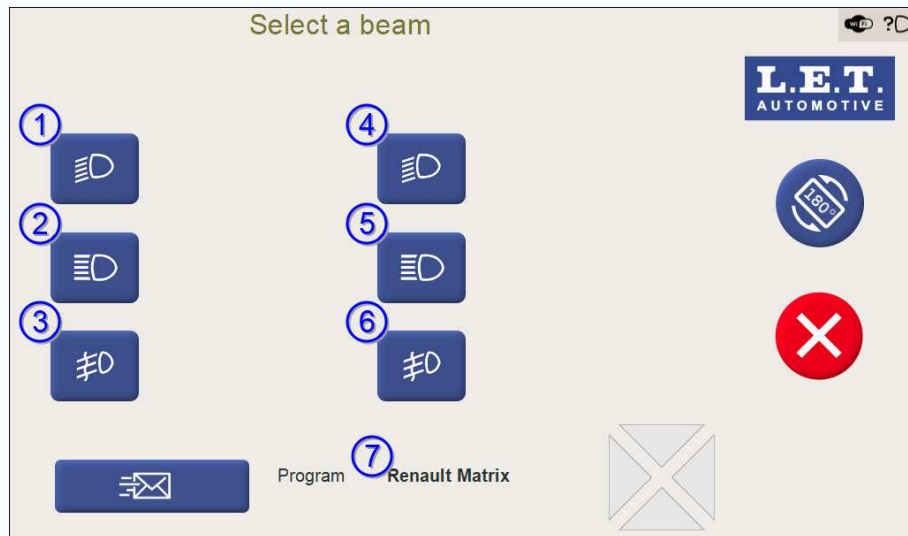

Figure 128: **Beam selection** screen for Renault Matrix program

#	Button	Description
1	First low beam	Starts the test of the first low beam.
2	First <i>Matrix</i> high beam	Starts the test of the first <i>Matrix</i> high beam.
3	First fog beam	Starts the test of the first fog beam.
4	Second low beam	Starts the test of the second low beam.
5	Second <i>Matrix</i> high beam	Starts the test of the second <i>Matrix</i> high beam.
6	Second fog beam	Starts the test of the second fog beam.
7	Program name	<i>Renault Matrix</i> program.

**Note:** Rotating the screen position affects to the position of the beam icons and beam selection buttons on the screen. The intelligence of the Luminoscope® automatically places the beam icons and beam selection buttons on the correct side of the vehicle. For both screen orientation modes, the beam icons and beam selection buttons which are closer to the left side of the vehicle are applicable for the headlamps on the left side. Those closer to the right side of the vehicle are applicable for the headlamps on the right side.

### Related information

[Glare free high beam with multiple static LED sources \(pg. 27\)](#)

[Left / right vehicle side definition \(pg. 61\)](#)

#### 7.3.8.1 Summary of the test sequence

What follows is a summarized listing of the steps for the test sequence. Refer to the next chapter for a detailed explanation of each step.

1. Align the Luminoscope® with the vehicle.

2. Establish an *OBD* connection with the *vehicle diagnostic tester*.
3. Adjust the low beams.
4. Switch the *Matrix* high beams in a special calibration mode.
5. Tap on the beam selection button corresponding with the left or right *Matrix* high beam.
6. Position the Luminoscope® sequentially in front of both *Matrix* high beams.
7. Adjust both *Matrix* high beams sequentially.
8. Exit the calibration mode.

### 7.3.8.2 Test sequence

1. Align the Luminoscope® with the vehicle.

Before the start of the actual test, the Luminoscope® should be properly aligned with the longitudinal axis (driving direction) of the vehicle. This is crucial in order to minimize the measurement result error in the horizontal direction. At the end of the chapter there is a link with related information on how to align the Luminoscope®.

2. Establish an *OBD* connection with the *vehicle diagnostic tester*.

The *vehicle diagnostic tester* must be connected to the *On Board Diagnostic (OBD)* port of the vehicle to switch the *Matrix* high beam in a special calibration mode.

Follow the specific instructions from the vehicle manufacturer on the dialog screen of the *vehicle diagnostic tester*.

3. Adjust the low beams.

Both low beams should be adjusted properly before the *Matrix* high beam calibration can be performed.

The following **Beam selection** screen is shown once both low beams are properly adjusted.

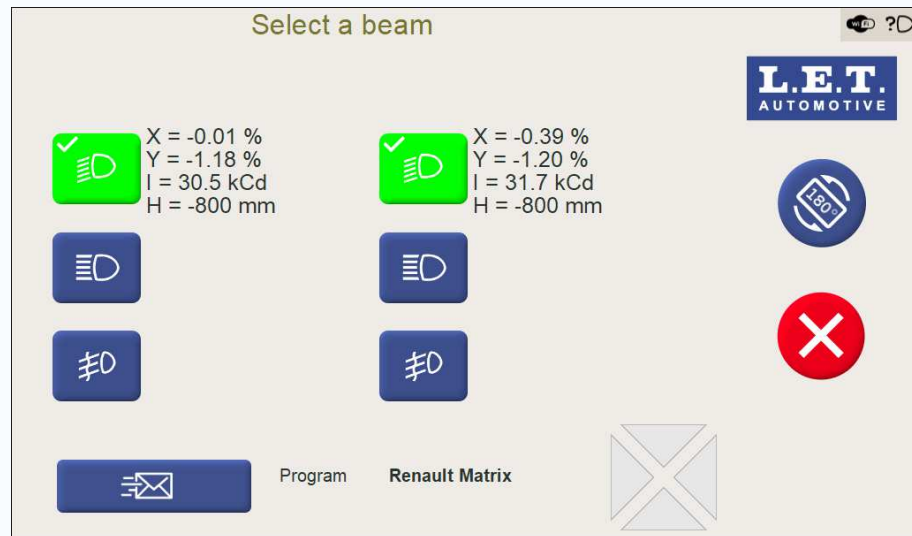

Figure 129: **Beam selection** screen with low beam test results

4. Switch the *Matrix* high beams in a special calibration mode.

Follow the specific instructions from the vehicle manufacturer on the dialog screen of the *vehicle diagnostic tester*.

**The next three steps are to be applied to both *Matrix* high beams sequentially.**

5. Tap on the beam selection button corresponding with the left or right *Matrix* high beam on the **Beam selection** screen to start its calibration.



**Note:** Rotating the screen position affects to the position of the beam icons and beam selection buttons on the screen. The intelligence of the Luminoscope® automatically places the beam icons and beam selection buttons on the correct side of the vehicle. For both screen orientation modes, the beam icons and beam selection buttons which are closer to the left side of the vehicle are applicable for the headlamps on the left side. Those closer to the right side of the vehicle are applicable for the headlamps on the right side.

6. Position the Luminoscope® in front of the selected *Matrix* high beam.

Position the Luminoscope® in front of the *Matrix* high beam projection, in such a way the light beam shines through the centre of the lens of the Luminoscope® while observing the beam projection on the lens of the Luminoscope®.

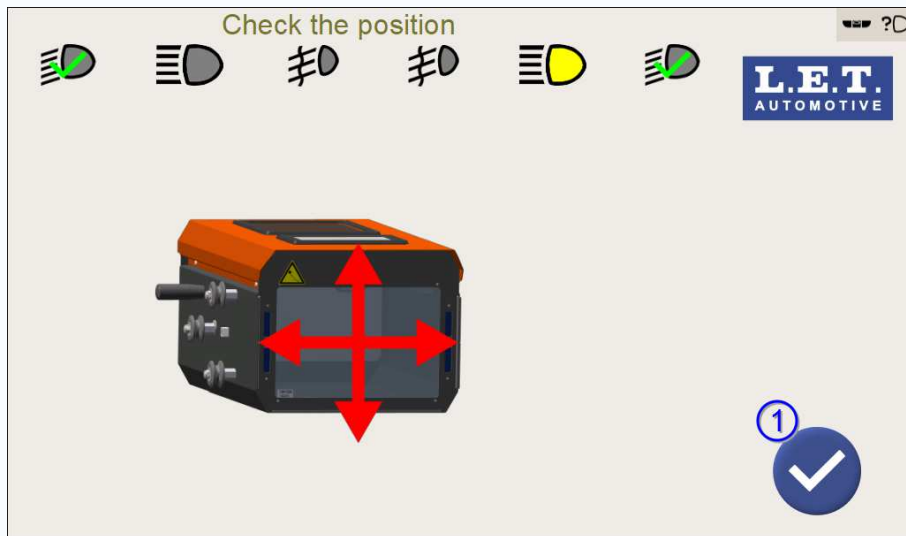

Figure 130: **Positioning** screen

Once the correct position is reached, tap on the **Validation** button 1 to proceed.

#### 7. Adjust the selected *Matrix* high beam.

Both *Matrix* high beams should be adjusted towards the tolerance zone in horizontal direction (X-direction) with exactly the same procedure.

**Note:** The *Matrix* high beam algorithm is capable to determine a central position in the reference *LED* source, based on the position of the left and right flank of the reference *LED* source.

Refer to the specific instructions from the vehicle manufacturer in order to physically adjust the horizontal setting of the headlamp (X-direction) with the corresponding adjustment screw.

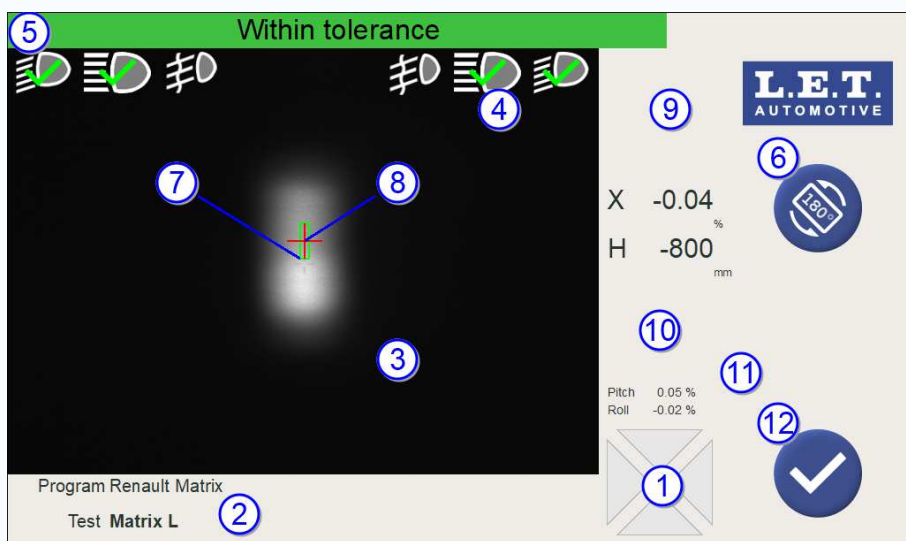

Figure 131: **Left Matrix high beam calibration**

#	Name	Description
1	<i>Position Check Arrows</i>	Indicates the direction(s) on which the optical block should be moved to achieve the optimal position in front of the headlamp. This position can change when adjusting the headlamp.
2	Information field	Depending on the Luminoscope® configuration, some related information such as the name of the selected program (Vehicle), the name of the test (Beam), license plate, etc. will be displayed.
3	Live headlamp beam image	Real time image of the headlamp beam including overlays for tolerance zone(s), algorithm measurement position, etc.
4	First high beam icon	<p>First high beam icon indicating the status of the beam.</p> <p>The meaning of the icon depends on its shape and color:</p> <ul style="list-style-type: none"> <li>• <b>Yellow</b> mark means <b>Test in progress</b>.</li> <li>• <b>Green</b> V-sign means <b>In tolerance</b>.</li> <li>• <b>Red</b> cross means <b>Out of tolerance</b>.</li> </ul>
5	Information banner	The information banner shows different status messages such as: <b>Test in progress</b> , <b>Within tolerance</b> , <b>Out of tolerance</b> , etc. Status, error or warning messages can also be displayed over there.
6	<b>Rotate screen</b> button	Rotate the screen position.
7	Aiming tolerance zone	The aiming tolerance zone allows the operator to adjust the headlamp correctly. Note that the aiming tolerance zone should always be smaller than the audit tolerance zone. This is to ensure that a correctly aimed headlamp at a workshop ( <i>using the smaller aiming tolerance zone</i> ) will pass the test in a government inspection station ( <i>using the larger audit tolerance zone</i> ).
8	Algorithm measurement position	The algorithm overlay (red cross) represents the algorithm measurement position on the headlamp beam image. In case of an aiming cycle, the red cross position should be aimed towards the centre of the aiming tolerance zone. In case of an audit cycle, the red cross position is evaluated. The actual position is displayed on the headlamp measurement result field.
9	Beam direction arrows	<p>The beam direction arrows indicate the direction(s) in which the headlamp should be moved to reach the target position inside the tolerance zone.</p> <p>The colour of the arrows indicates the live status of the aiming:</p> <ul style="list-style-type: none"> <li>• <b>Green</b> means the result is <i>inside</i> the tolerance zone.</li> <li>• <b>Yellow</b> means the result is <i>close</i> to the tolerance zone.</li> <li>• <b>Red</b> means the result is <i>far away</i> from the tolerance zone.</li> </ul>

#	Name	Description
10	Headlamp measurement results field	Depending on the chosen algorithm and Luminoscope® configuration, headlamp measurement results such as horizontal beam position (X), vertical beam position (Y), etc. are displayed here.
11	ESL (Electronic Spirit Level) module angles	Measured Pitch and Roll angle of the ESL (Electronic Spirit Level) module, if applicable.
12	<b>Validation</b> button	If the <i>live validation</i> function is activated, tapping on this button will store the beam measurement result. The result is unconditionally stored whether the algorithm measurement position is <i>Within tolerance</i> or <i>Out of tolerance</i> .

The following **Beam selection** screen is shown once both *Matrix* high beams are properly adjusted.

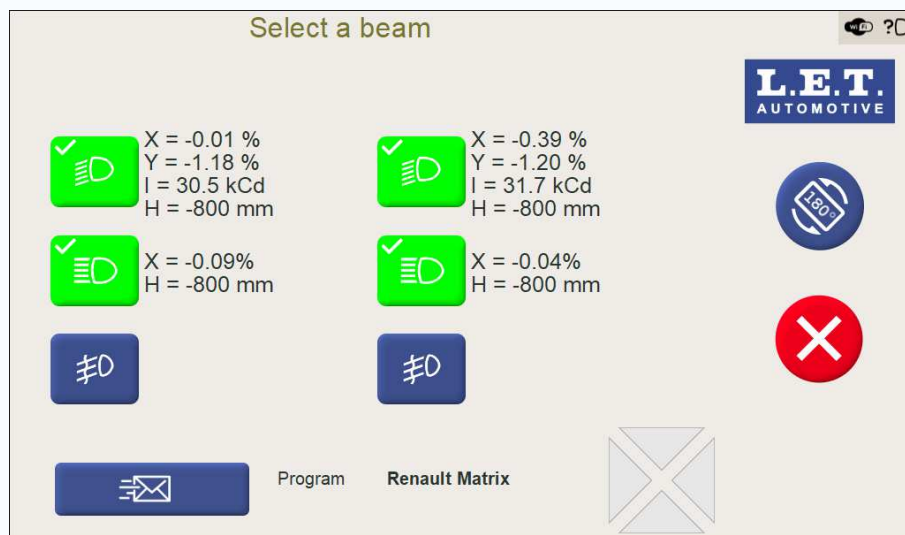

Figure 132: **Beam selection** screen with test results of both low beams and Matrix high beams

#### 8. Exit the calibration mode.

Follow the specific instructions from the vehicle manufacturer on the dialog screen of the *vehicle diagnostic tester*.

#### Related information

[Alignment with the vehicle \(pg. 62\)](#)

### 7.3.9 VOL American low beam sequence

This chapter explains the use of the OEM program selection for adjustment of American VOL low beams to be used in the Belgian traffic.



**Note:** This specific *SAE VOL* selection is only applicable to vehicles which are equipped with American *VOL* low beams.

Tap on the **VOL** button 1 on the **OEM program selection** screen.

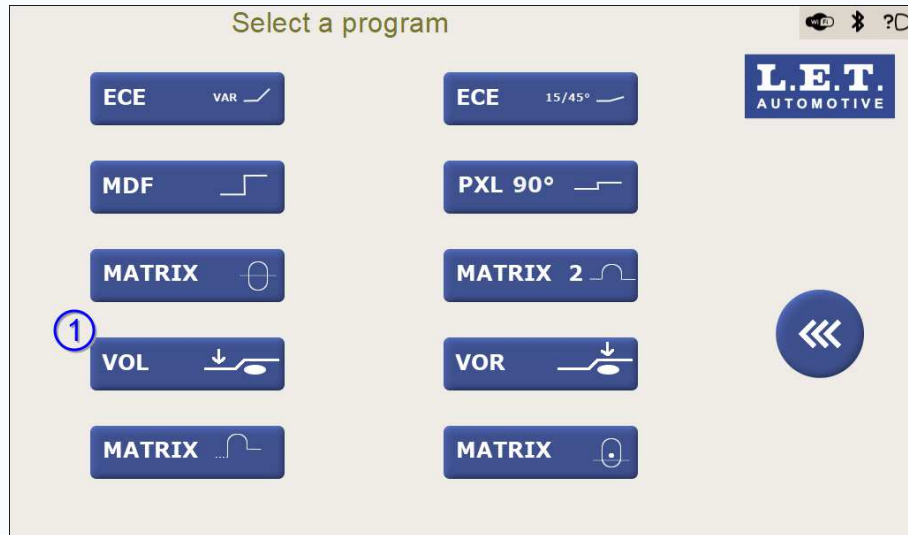

Figure 133: **OEM program selection** screen with **VOL** button

The **Beam selection** screen for the *VOL* program is now displayed.

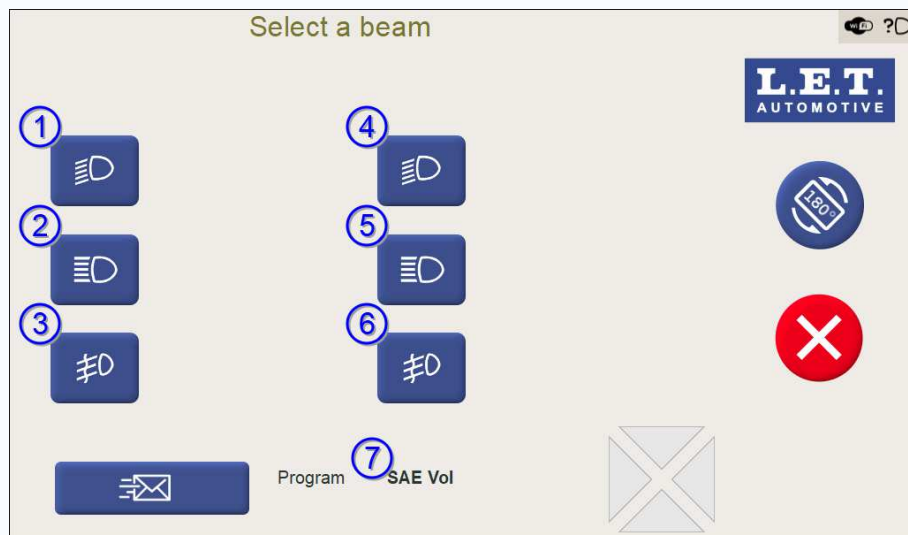

Figure 134: **Beam selection** screen for *VOL* program

#	Button	Description
1	First <i>VOL</i> low beam	Starts the test of the first <i>VOL</i> low beam.
2	First high beam	Starts the test of the first high beam.
3	First fog beam	Starts the test of the first fog beam.
4	Second <i>VOL</i> low beam	Starts the test of the second <i>VOL</i> low beam.
5	Second high beam	Starts the test of the second high beam.

#	Button	Description
6	Second fog beam	Starts the test of the second fog beam.
7	Program name	VOL program.



**Note:** Rotating the screen position affects to the position of the beam icons and beam selection buttons on the screen. The intelligence of the Luminoscope® automatically places the beam icons and beam selection buttons on the correct side of the vehicle. For both screen orientation modes, the beam icons and beam selection buttons which are closer to the left side of the vehicle are applicable for the headlamps on the left side. Those closer to the right side of the vehicle are applicable for the headlamps on the right side.

### Related information

[SAE or American low beam](#) (pg. 24)

[Left / right vehicle side definition](#) (pg. 61)

#### 7.3.9.1 Summary of the test sequence

What follows is a summarized listing of the steps for the test sequence. Refer to the next chapter for a detailed explanation of each step.

1. Align the Luminoscope® with the vehicle.
2. Tap on the beam selection button corresponding with the left or right VOL low beam.
3. Position the Luminoscope® sequentially in front of both VOL low beams.
4. Adjust both VOL low beams sequentially.

#### 7.3.9.2 Test sequence

1. Align the Luminoscope® with the vehicle.

Before the start of the actual test, the Luminoscope® should be properly aligned with the longitudinal axis (driving direction) of the vehicle. This is crucial in order to minimize the measurement result error in the horizontal direction. At the end of the chapter there is a link with related information on how to align the Luminoscope®.

**The next three steps are to be applied to both VOL low beams sequentially.**

2. Tap on the beam selection button corresponding with the left or right VOL low beam on the **Beam selection** screen to start its calibration.



**Note:** Rotating the screen position affects to the position of the beam icons and beam selection buttons on the screen. The intelligence of the Luminoscope® automatically places the beam icons and beam selection buttons on the correct side of the vehicle. For both screen orientation modes, the beam icons and beam selection buttons which are closer to

the left side of the vehicle are applicable for the headlamps on the left side. Those closer to the right side of the vehicle are applicable for the headlamps on the right side.

**3.** Position the Luminoscope® in front of the selected VOL low beam.

Make use of the electronic *Position Check* system.

Once the optimal position in front of the headlamp is achieved, the Luminoscope® proceeds automatically to the next phase in the test.

**4.** Adjust the selected VOL low beam.

Both VOL low beams should be adjusted with exactly the same procedure.

**Note:** The VOL low beam algorithm is capable to determine the required vertical position of the VOL low beam *cut-off* line.

The vertical position of the *cut-off* line is measured at 4,35% (2,5°) to the left of the absolute zero reference point of the Luminoscope®.

**Note:** The headlamp should only be adjusted in vertical direction (Y direction). The vertical *cut-off* position should be set to -1,25% to be used in Belgian traffic.

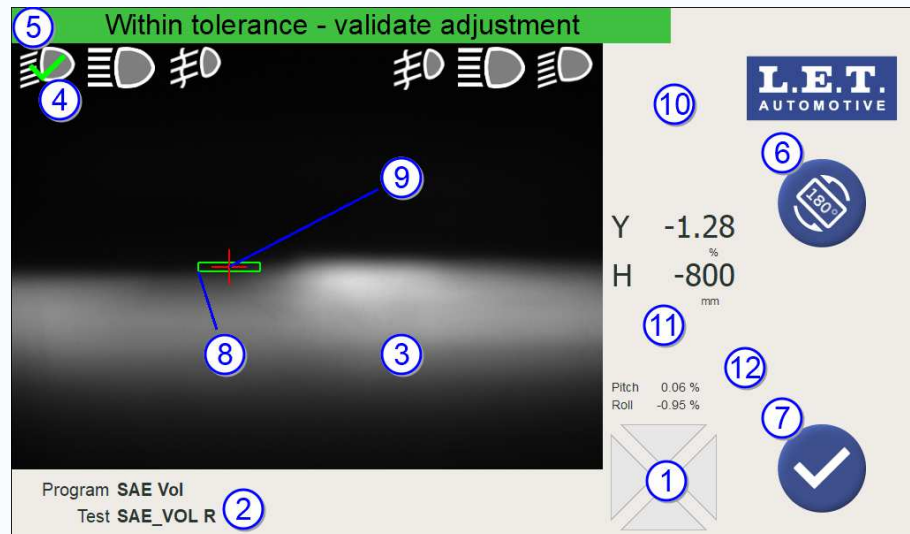

Figure 135: Right VOL low beam adjustment

#	Name	Description
1	<i>Position Check Arrows</i>	Indicates the direction(s) on which the optical block should be moved to achieve the optimal position in front of the headlamp. This position can change when adjusting the headlamp.
2	Information field	Depending on the Luminoscope® configuration, some related information such as the name of the selected program (Vehicle), the name of the test (Beam), license plate, etc. will be displayed.

#	Name	Description
3	Live headlamp beam image	Real time image of the headlamp beam including overlays for tolerance zone(s), algorithm measurement position, etc.
4	Low beam icon	<p>Low beam icon indicating the status of the beam.</p> <p>The meaning of the icon depends on its shape and color:</p> <ul style="list-style-type: none"> <li>• <b>Yellow</b> mark means <b>Test in progress</b>.</li> <li>• <b>Green</b> V-sign means <b>In tolerance</b>.</li> <li>• <b>Red</b> cross means <b>Out of tolerance</b>.</li> </ul>
5	Information banner	The information banner shows different status messages such as: <b>Test in progress</b> , <b>Within tolerance</b> , <b>Out of tolerance</b> , etc. Status, error or warning messages can also be displayed over there.
6	<b>Rotate screen</b> button	Rotate the screen position.
7	<b>Validation</b> button	If the <i>live validation</i> function is activated, tapping on this button will store the beam measurement result. The result is unconditionally stored whether the algorithm measurement position is <i>Within tolerance</i> or <i>Out of tolerance</i> .
8	Aiming tolerance zone	The aiming tolerance zone allows the operator to adjust the headlamp correctly. Note that the aiming tolerance zone should always be smaller than the audit tolerance zone. This is to ensure that a correctly aimed headlamp at a workshop ( <i>using the smaller aiming tolerance zone</i> ) will pass the test in a government inspection station ( <i>using the larger audit tolerance zone</i> ).
9	Algorithm measurement position	The algorithm overlay (red cross) represents the algorithm measurement position on the headlamp beam image. In case of an aiming cycle, the red cross position should be aimed towards the centre of the aiming tolerance zone. In case of an audit cycle, the red cross position is evaluated. The actual position is displayed on the headlamp measurement result field.
10	Beam direction arrows	<p>The beam direction arrows indicate the direction(s) in which the headlamp should be moved to reach the target position inside the tolerance zone.</p> <p>The colour of the arrows indicates the live status of the aiming:</p> <ul style="list-style-type: none"> <li>• <b>Green</b> means the result is <i>inside</i> the tolerance zone.</li> <li>• <b>Yellow</b> means the result is <i>close</i> to the tolerance zone.</li> <li>• <b>Red</b> means the result is <i>far away</i> from the tolerance zone.</li> </ul>
11	Headlamp measurement results field	Depending on the chosen algorithm and Luminoscope® configuration, headlamp measurement results such as horizontal beam position (X), vertical beam position (Y), etc. are displayed here.

#	Name	Description
12	ESL (Electronic Spirit Level) module angles	Measured Pitch and Roll angle of the ESL (Electronic Spirit Level) module, if applicable.

The following **Beam selection** screen is shown when both VOL low beams are properly adjusted.

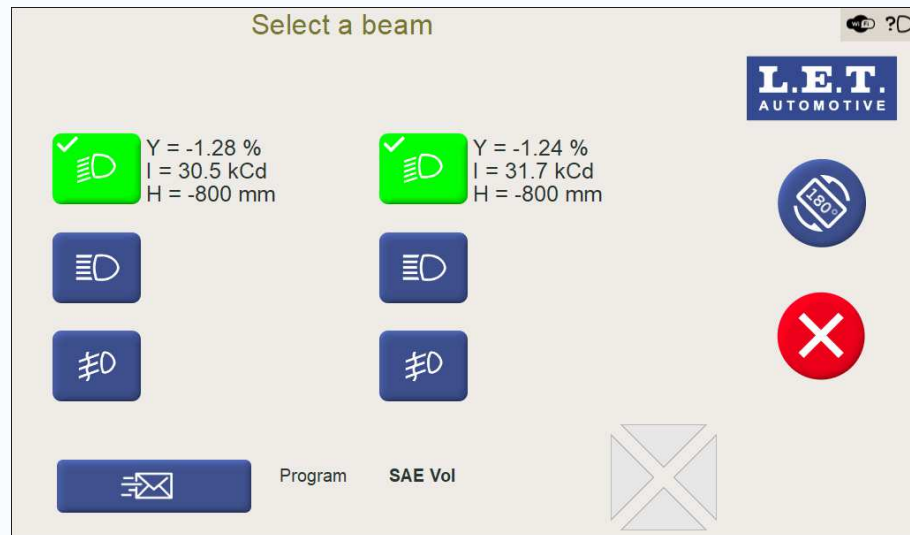

Figure 136: **Beam selection** screen with SAE VOL low beam test results



**Note:** Rotating the screen position affects to the position of the beam icons and beam selection buttons on the screen. The intelligence of the Luminoscope® automatically places the beam icons and beam selection buttons on the correct side of the vehicle. For both screen orientation modes, the beam icons and beam selection buttons which are closer to the left side of the vehicle are applicable for the headlamps on the left side. Those closer to the right side of the vehicle are applicable for the headlamps on the right side.

#### Related tasks

[Positioning in front of the headlamp](#) (pg. 85)

#### Related information

[Alignment with the vehicle](#) (pg. 62)

### 7.3.10 VOR American low beam sequence

This chapter explains the use of the OEM program selection for adjustment of American VOR low beams to be used in the Belgian traffic.

**Note:** This specific SAE VOR selection is only applicable to vehicles which are equipped with American VOR low beams.

Tap on the **VOR** button 1 on the **OEM program selection** screen.

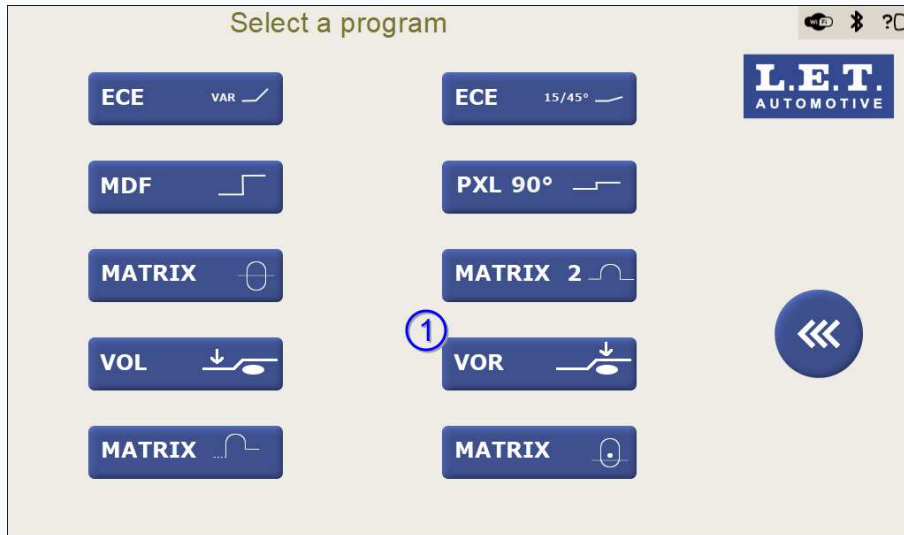

Figure 137: **OEM program selection** screen with **VOR** button

The **Beam selection** screen for the **VOR** program is now displayed.

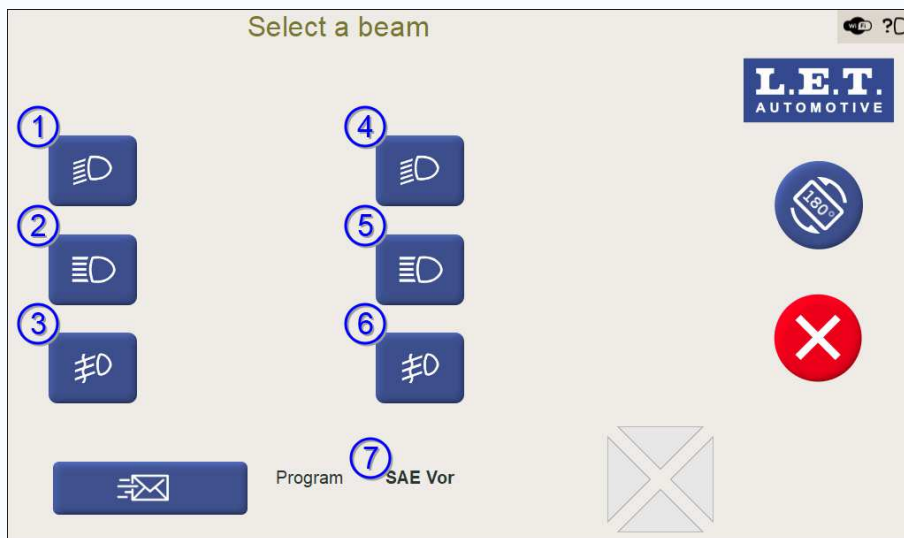

Figure 138: **Beam selection** screen for **VOR** program

#	Button	Description
1	First VOR low beam	Starts the test of the first VOR low beam.
2	First high beam	Starts the test of the first high beam.
3	First fog beam	Starts the test of the first fog beam.
4	Second VOR low beam	Starts the test of the second VOR low beam.
5	Second high beam	Starts the test of the second high beam.

#	Button	Description
6	Second fog beam	Starts the test of the second fog beam.
7	Program name	VOR program.



**Note:** Rotating the screen position affects to the position of the beam icons and beam selection buttons on the screen. The intelligence of the Luminoscope® automatically places the beam icons and beam selection buttons on the correct side of the vehicle. For both screen orientation modes, the beam icons and beam selection buttons which are closer to the left side of the vehicle are applicable for the headlamps on the left side. Those closer to the right side of the vehicle are applicable for the headlamps on the right side.

### Related information

[SAE or American low beam](#) (pg. 24)

[Left / right vehicle side definition](#) (pg. 61)

#### 7.3.10.1 Summary of the test sequence

What follows is a summarized listing of the steps for the test sequence. Refer to the next chapter for a detailed explanation of each step.

1. Align the Luminoscope® with the vehicle.
2. Tap on the beam selection button corresponding with the left or right VOR low beam.
3. Position the Luminoscope® sequentially in front of both VOR low beams.
4. Adjust both VOR low beams sequentially.

#### 7.3.10.2 Test sequence

1. Align the Luminoscope® with the vehicle.

Before the start of the actual test, the Luminoscope® should be properly aligned with the longitudinal axis (driving direction) of the vehicle. This is crucial in order to minimize the measurement result error in the horizontal direction. At the end of the chapter there is a link with related information on how to align the Luminoscope®.

**The next three steps are to be applied to both VOR low beams sequentially.**

2. Tap on the beam selection button corresponding with the left or right VOR low beam on the **Beam selection** screen to start its calibration.



**Note:** Rotating the screen position affects to the position of the beam icons and beam selection buttons on the screen. The intelligence of the Luminoscope® automatically places the beam icons and beam selection buttons on the correct side of the vehicle. For both screen orientation modes, the beam icons and beam selection buttons which are closer to

the left side of the vehicle are applicable for the headlamps on the left side. Those closer to the right side of the vehicle are applicable for the headlamps on the right side.

**3.** Position the Luminoscope® in front of the selected VOR low beam.

Make use of the electronic *Position Check* system.

Once the optimal position in front of the headlamp is achieved, the Luminoscope® proceeds automatically to the next phase in the test.

**4.** Adjust the selected VOR low beam.

Both VOR low beams should be adjusted with exactly the same procedure.

**Note:** The VOR low beam algorithm is capable to determine the required vertical position of the VOR low beam *cut-off* line.

The vertical position of the *cut-off* line is measured at 3,50% (2,0°) to the right of the absolute zero reference point of the Luminoscope®.

**Note:** The headlamp should only be adjusted in vertical direction (Y direction). The vertical *cut-off* position should be set to -0,5% to be used in Belgian traffic.

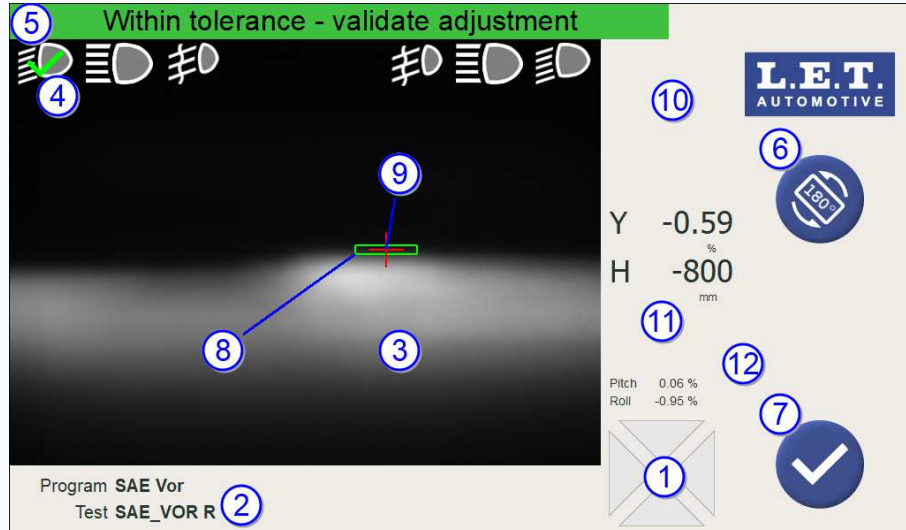

Figure 139: Right VOR low beam adjustment

#	Name	Description
1	<i>Position Check Arrows</i>	Indicates the direction(s) on which the optical block should be moved to achieve the optimal position in front of the headlamp. This position can change when adjusting the headlamp.
2	Information field	Depending on the Luminoscope® configuration, some related information such as the name of the selected program (Vehicle), the name of the test (Beam), license plate, etc. will be displayed.

#	Name	Description
3	Live headlamp beam image	Real time image of the headlamp beam including overlays for tolerance zone(s), algorithm measurement position, etc.
4	Low beam icon	Low beam icon indicating the status of the beam. The meaning of the icon depends on its shape and color: <ul style="list-style-type: none"> <li>• <b>Yellow</b> mark means <b>Test in progress</b>.</li> <li>• <b>Green</b> V-sign means <b>In tolerance</b>.</li> <li>• <b>Red</b> cross means <b>Out of tolerance</b>.</li> </ul>
5	Information banner	The information banner shows different status messages such as: <b>Test in progress</b> , <b>Within tolerance</b> , <b>Out of tolerance</b> , etc. Status, error or warning messages can also be displayed over there.
6	<b>Rotate screen</b> button	Rotate the screen position.
7	<b>Validation</b> button	If the <i>live validation</i> function is activated, tapping on this button will store the beam measurement result. The result is unconditionally stored whether the algorithm measurement position is <i>Within tolerance</i> or <i>Out of tolerance</i> .
8	Aiming tolerance zone	The aiming tolerance zone allows the operator to adjust the headlamp correctly. Note that the aiming tolerance zone should always be smaller than the audit tolerance zone. This is to ensure that a correctly aimed headlamp at a workshop ( <i>using the smaller aiming tolerance zone</i> ) will pass the test in a government inspection station ( <i>using the larger audit tolerance zone</i> ).
9	Algorithm measurement position	The algorithm overlay (red cross) represents the algorithm measurement position on the headlamp beam image. In case of an aiming cycle, the red cross position should be aimed towards the centre of the aiming tolerance zone. In case of an audit cycle, the red cross position is evaluated. The actual position is displayed on the headlamp measurement result field.
10	Beam direction arrows	The beam direction arrows indicate the direction(s) in which the headlamp should be moved to reach the target position inside the tolerance zone. The colour of the arrows indicates the live status of the aiming: <ul style="list-style-type: none"> <li>• <b>Green</b> means the result is <i>inside</i> the tolerance zone.</li> <li>• <b>Yellow</b> means the result is <i>close</i> to the tolerance zone.</li> <li>• <b>Red</b> means the result is <i>far away</i> from the tolerance zone.</li> </ul>
11	Headlamp measurement results field	Depending on the chosen algorithm and Luminoscope® configuration, headlamp measurement results such as horizontal beam position (X), vertical beam position (Y), etc. are displayed here.

#	Name	Description
12	ESL (Electronic Spirit Level) module angles	Measured Pitch and Roll angle of the ESL (Electronic Spirit Level) module, if applicable.

The following **Beam selection** screen is shown when both VOR low beams are properly adjusted.

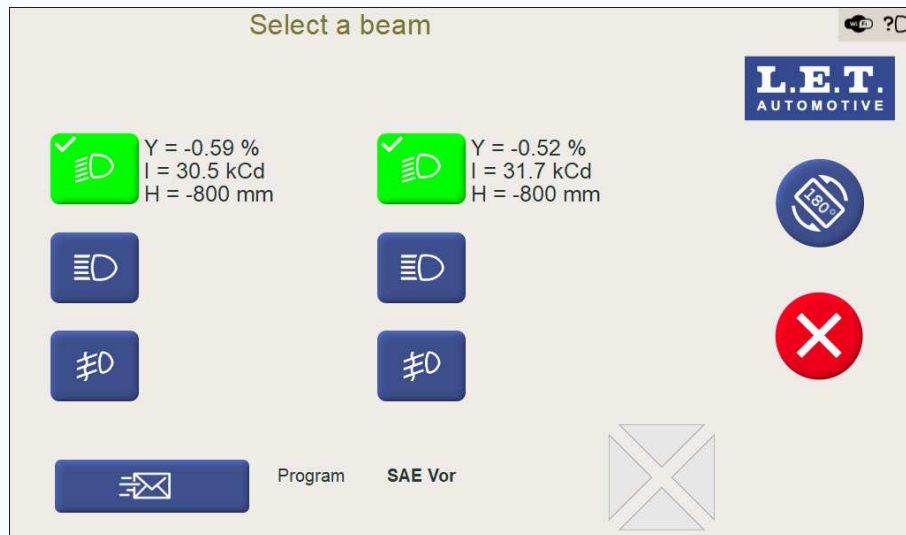

Figure 140: **Beam selection** screen with SAE VOR low beam test results



**Note:** Rotating the screen position affects to the position of the beam icons and beam selection buttons on the screen. The intelligence of the Luminoscope® automatically places the beam icons and beam selection buttons on the correct side of the vehicle. For both screen orientation modes, the beam icons and beam selection buttons which are closer to the left side of the vehicle are applicable for the headlamps on the left side. Those closer to the right side of the vehicle are applicable for the headlamps on the right side.

#### Related tasks

[Positioning in front of the headlamp](#) (pg. 85)

#### Related information

[Alignment with the vehicle](#) (pg. 62)

## 7.4 Matrix headlight mode

The **MATRIX** button enables the SLA 40 to calibrate a wide range of matrix headlights. This chapter provides an overview of the **MATRIX** button and its functionality.

Matrix headlights are a key advancement in automotive lighting systems, offering precise control over the distribution of light on the road.

There are various implementations of matrix headlights, as manufacturers develop their own solutions based on unique concepts, each with specific advantages tailored to different vehicle models and driving conditions.

Matrix headlights use an array of individual light elements that can be controlled independently, allowing for the adaptation of the light pattern to avoid dazzling other drivers, while ensuring optimal illumination for the road ahead.

These systems are designed to enhance both safety and driving comfort by dynamically adjusting the lighting in real-time, depending on factors such as speed, road conditions, and the presence of other vehicles.

Due to the diversity in matrix headlight designs, the SLA 40 is equipped with algorithms capable of handling multiple variations, ensuring accurate alignment and verification processes across different vehicles.

The setup and calibration procedures are tailored for the specific features of each matrix headlight implementation, taking into consideration both the hardware and software configurations involved.

### 7.4.1 Test cycle sequences

The **MATRIX** button on the **Program selection** screen provides access to some special *Matrix* sequences for various beam types.

**Note:** The **MATRIX** button is available on certain cases. Use this chapter as a reference for understanding the different possibilities of the Luminoscope® system.

Starting from the **Program selection** screen.

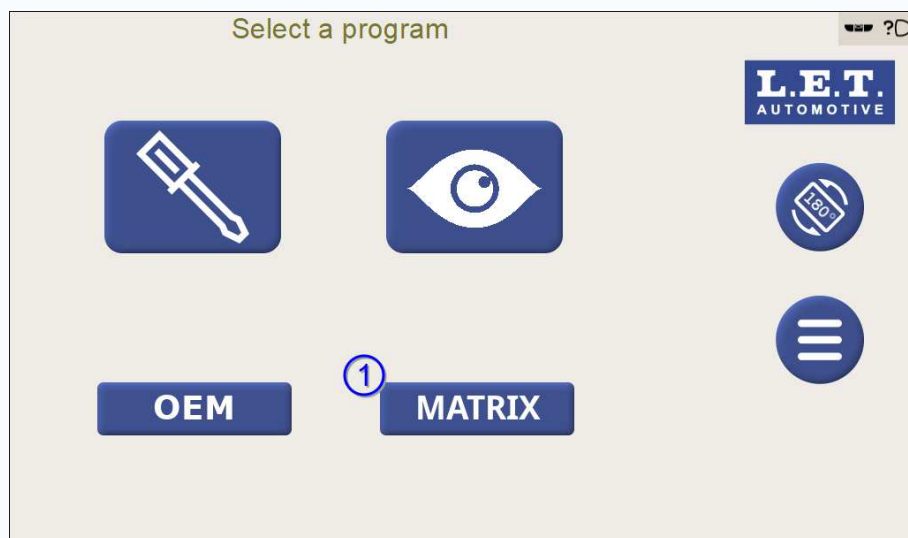

Figure 141: **Program selection** screen with **MATRIX** button

**Note:** The screen may have a different appearance depending on the customer's specific implementation.

#### Accessing the matrix test cycles

1. Tap on the **MATRIX** button 1 on the **Program selection** screen.

The **MATRIX cycle selection** screen is now displayed.

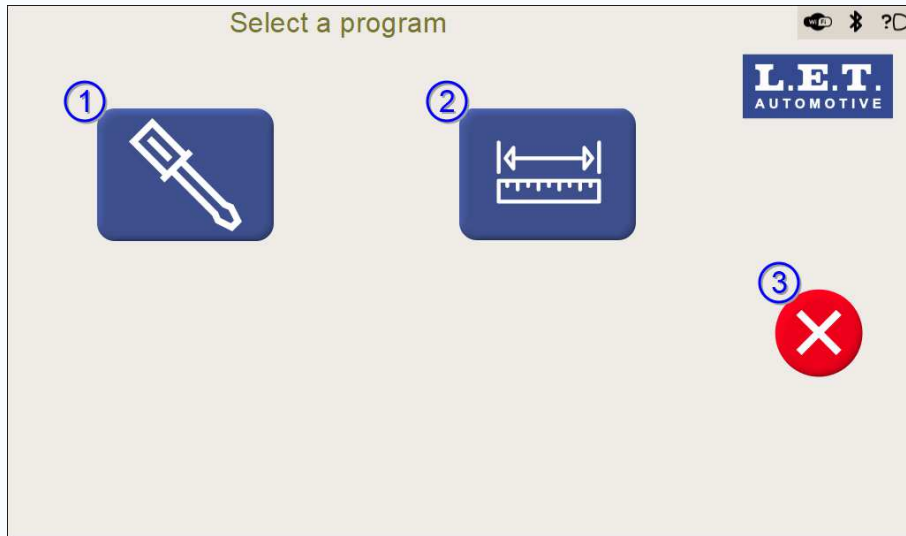

Figure 142: **MATRIX cycle selection** screen with **MATRIX** button

2. Tap on button 1 to select an *aiming cycle* or either tap on button 2 for selecting a *measurement cycle* instead. Alternatively, tap on the button 3 to return to the previous screen.

The following chapters describe the two options in detail.

After tapping on either button, the next screen will be displayed:

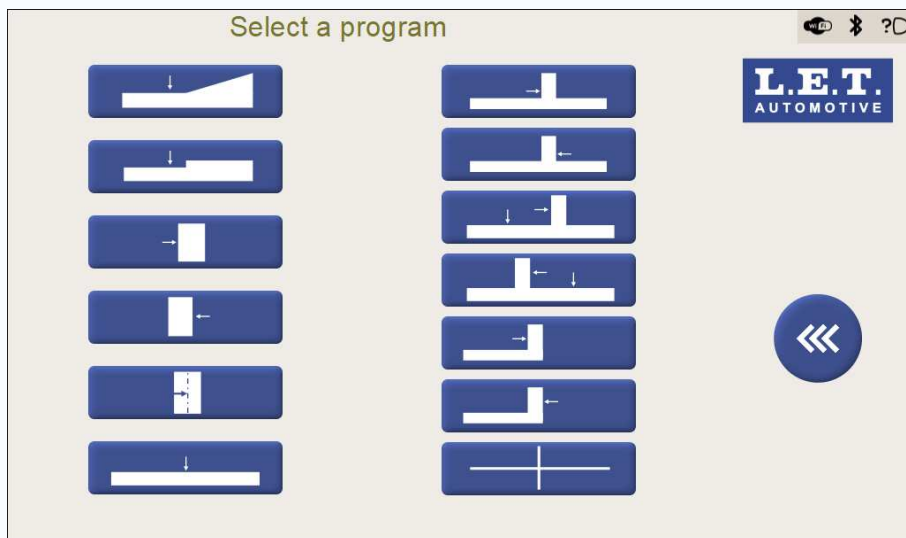

Figure 143: **MATRIX cycle selection** screen

Each icon shows the shape of the beam to be aligned. Arrows on the icon indicate which beam point or flank will be measured. If two flanks are measured, two arrows appear.

**Remember:** Keep in mind that the new matrix function uses an orthogonal coordinate system. The X-axis runs horizontally and increases to the right. The Y-axis runs vertically and increases upward.

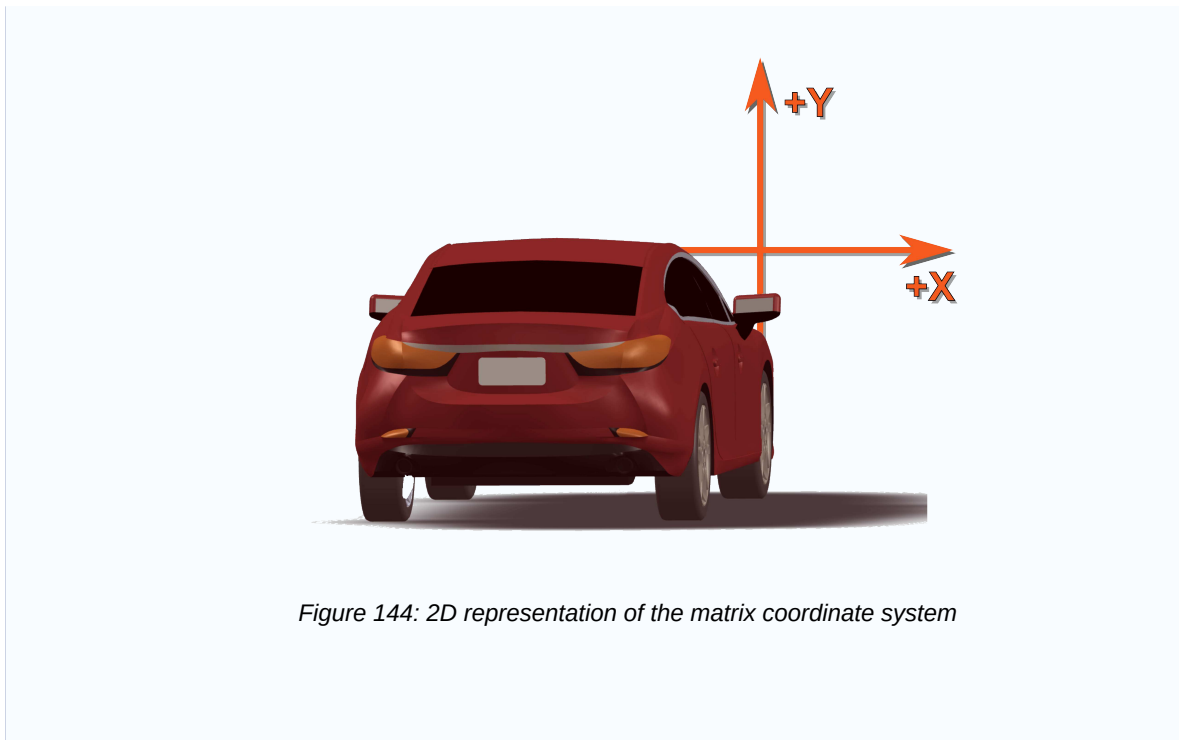

Figure 144: 2D representation of the matrix coordinate system

#### 7.4.1.1 Aiming cycle

After selecting the *aiming cycle*, the **Program selection** screen lets you select the specific sequence based on the characteristics of the headlamp under test.

Starting from the **MATRIX cycle selection** screen:

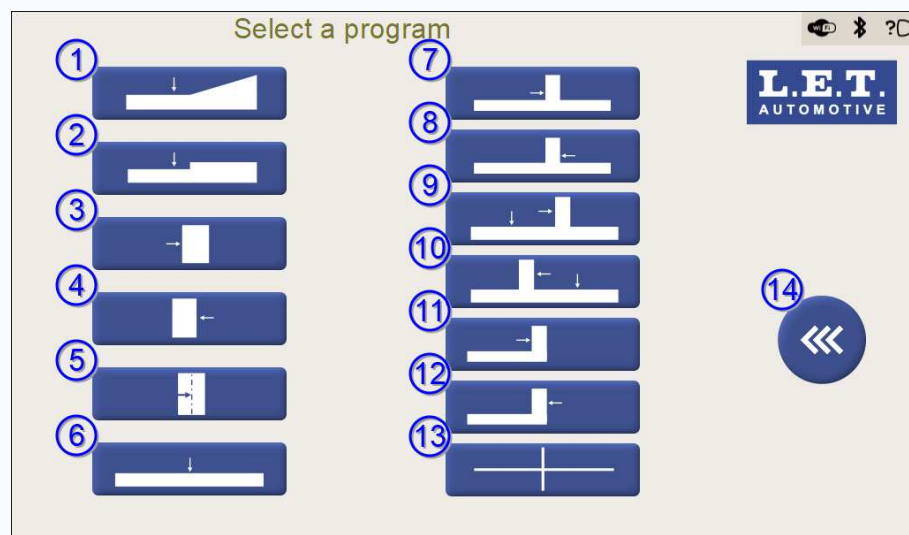

Figure 145: **MATRIX cycle selection** screen

Refer to the previous introduction chapter for previous instructions if required.

1. Identify the lamp matrix model.
  - a) Use the manufacturer instructions to identify the correct beam.
  - b) Alternatively, project the beam onto the Luminoscope® lens, look at the shape of the projected beam and match it to the correct icon.

2. Choose the matrix mode corresponding with the characteristics of the headlamp to be calibrated by tapping in any of the buttons 1 to 13. Alternatively tap on **Back** button 14 to return.

The arrows and the shape of the icon define the type of matrix it can measure.

The **Target modification** screen is displayed:



Figure 146: **Target modification** screen

3. Locate the target point positions information.

Typically, the builder provides this information on the matrix beams in the technical documentation of the vehicle. The required information consists in:

- Units on which the targets are specified,
- Vertical position of the target point,
- Horizontal position of the target point.

4. Set the target point positions.

- a) Select the units to apply with the sliding selector 12.
- b) Use position tuning buttons.

Use buttons 1 to 4 to adjust the vertical position.

Use buttons 5 to 8 to adjust the horizontal position



**Tip:** These buttons are active only when they apply to the selected matrix light type.

- c) Check current values.

The current value and unit for vertical adjustment appear in field 9.

The current value and unit for horizontal adjustment appear in field 10.

- d) Confirm settings by tapping on the **Validation** button 11.

The **Check position** screen is displayed:



Figure 147: **Check position** screen

5. Use the lens to align the Luminoscope® with the center of the beam.

Matrix beams use to be very narrow, so accurate alignment is crucial.

Make sure that the center of the matrix beam projects as close as possible to the center of the lens.

6. Tap on the **Validation** button once everything is ready.  
The following screen is displayed:

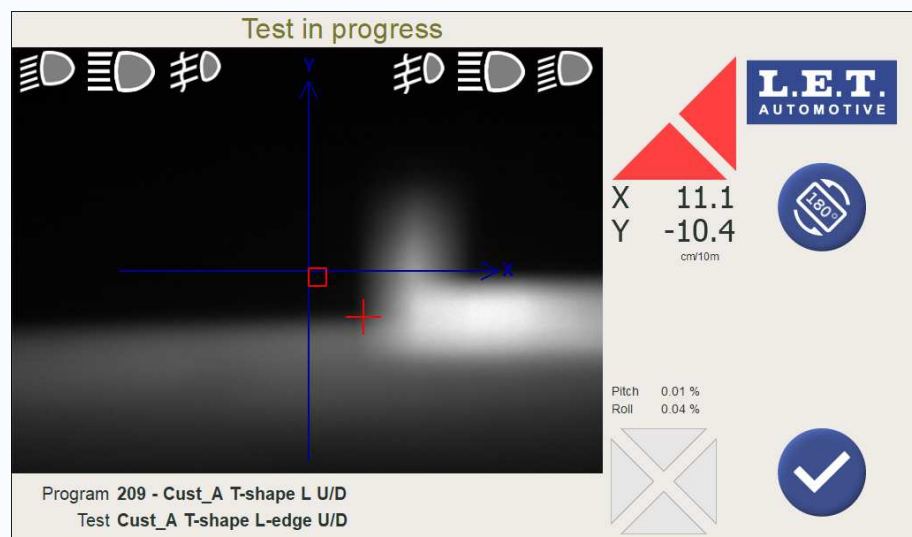

Figure 148: **Initial Test** screen

7. Align the headlamp.

By making fine precise adjustments to the headlamp position, place the cross inside the initially red square, following the indications of the vehicle manufacturer.



**Note:** Input the resultant values via the *OBD* port when requested by the system.

This square becomes green when the alignment of the headlamp is in tolerance margins.

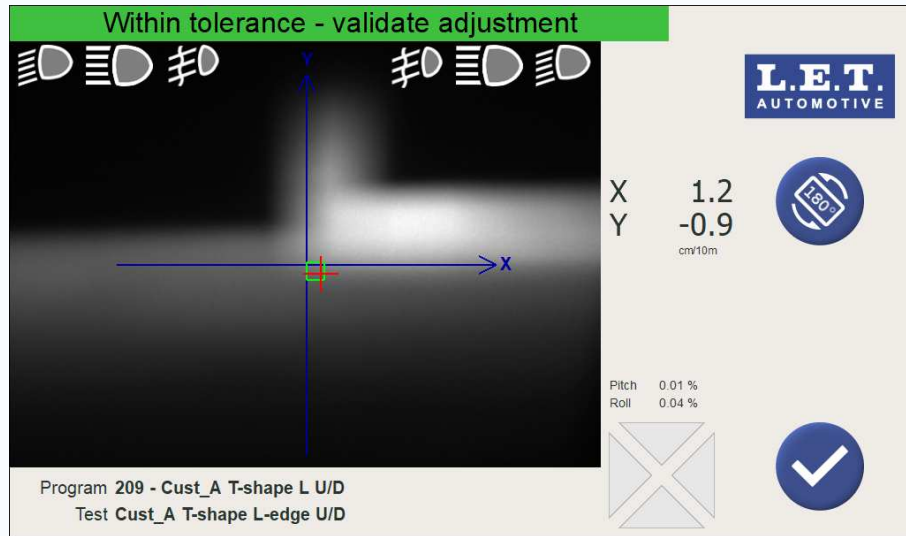

Figure 149: Successful **Test** screen

8. Proceed to the next headlamp.

#### 7.4.1.2 Measurement cycle

After selecting the *measurement cycle*, the **Program selection** screen lets you select the specific sequence based on the characteristics of the headlamp under test.

Starting from the **MATRIX cycle selection** screen:

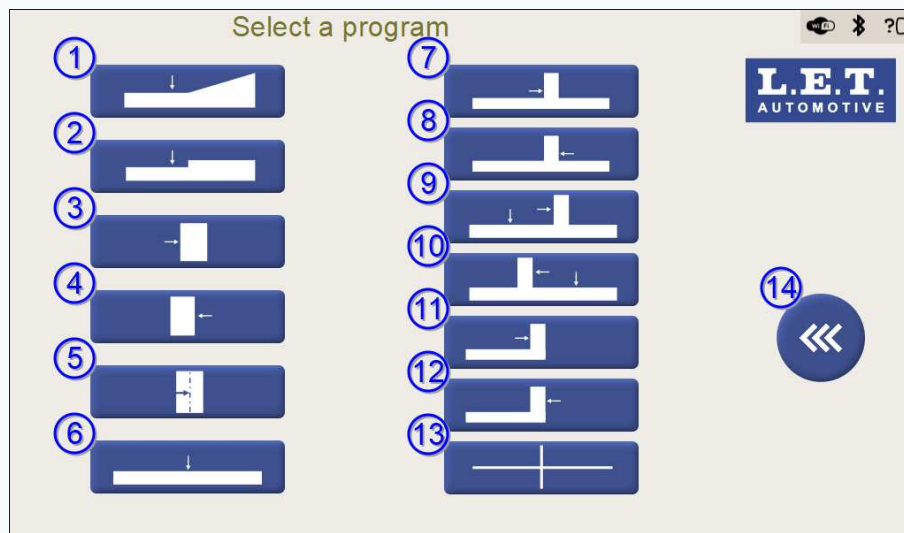

Figure 150: **MATRIX cycle selection** screen

Refer to the previous introduction chapter for previous instructions if required.

1. Choose the matrix mode corresponding with the characteristics of the headlamp to be measured by tapping in any of the buttons 1 to 13. Alternatively tap on **Back** button 14 to return.

The arrows and the shape of the icon define the type of matrix it can measure.  
The **Target modification** screen is displayed:



Figure 151: **Target modification** screen

2. Select the units to apply according to the reference data with the sliding selector 1. Alternatively, tap on button 2 to return to the previous screen.

Typically, the builder provides this information on the matrix beams in the technical documentation of the vehicle. The required information consists in:

- Units on which the targets are specified,
- Vertical position of the target point,
- Horizontal position of the target point.

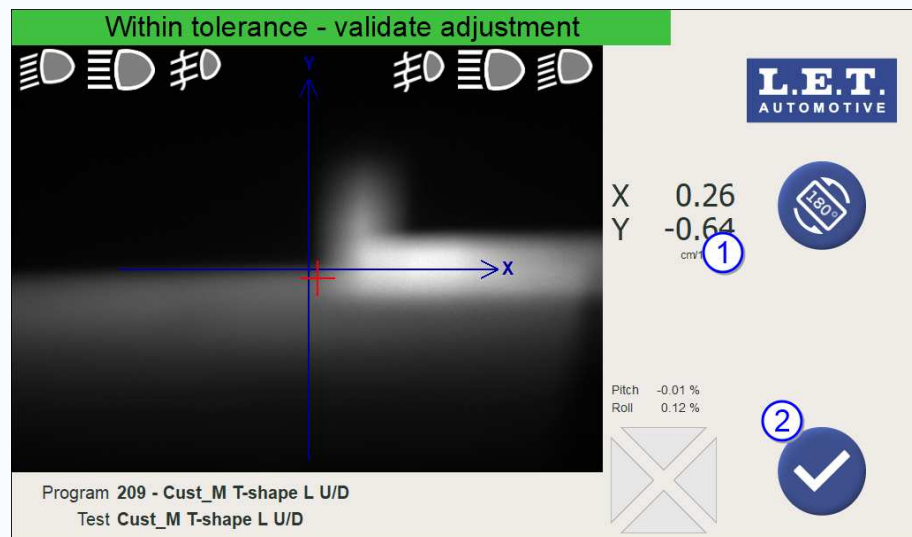

Figure 152: **Test** screen

Use the values read by the Luminoscope® on 1 for assessing the current alignment status of the beam under test.



**Note:** Input the resultant values via the *OBD* port when requested by the system.

**3.** Tap on **Back** button 2 to return or to proceed to other lamp.

---

# 8 Navigation map

---

This navigation map shows the most important screens on the Luminoscope® system and how to get there, including a reference to the corresponding chapter in the manual.

## Program selection screen

 **Note:** The screen may have a different appearance depending on the customer's specific implementation.

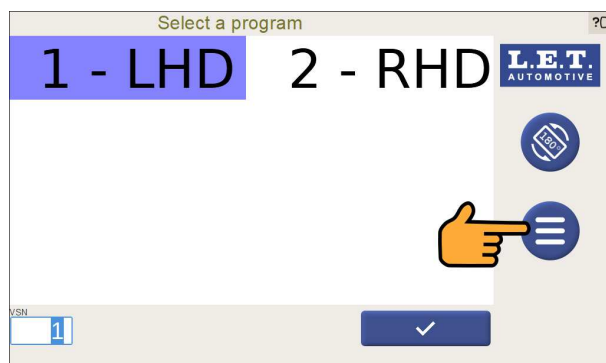

The **Program selection** screen is displayed after starting up the system and offers different programs. This allows the operator to select a preconfigured test cycle sequence. There's also a **System** button to access the **System** screen.

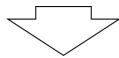

Tap on the button above to enter the **System** screen.

### Related tasks

[Program selection screen \(pg. 78\)](#)

## System screen

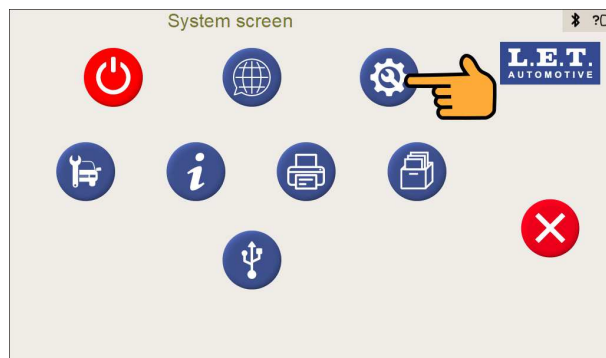

The **System** screen displays different system items.

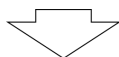

Tap on the button above to enter the **Setup login** screen.

## Related tasks

[System screen](#) (pg. 191)

## Setup login screen

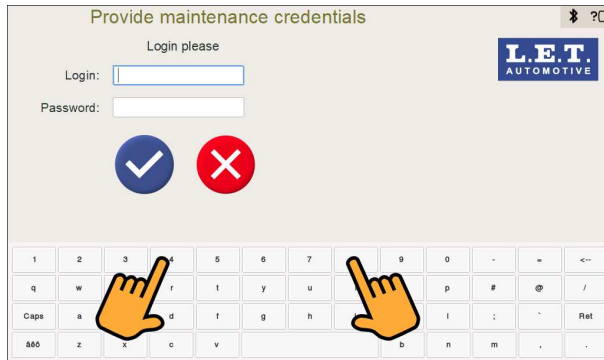

The **Setup login** screen allows the operator to enter the **Setup** screen.

Enter your credentials and tap on the **Validation** button.

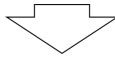

## Setup screen



**Note:** The access rights to the different menus on the screen are hierarchical and depend on the applied login level, which is password protected.

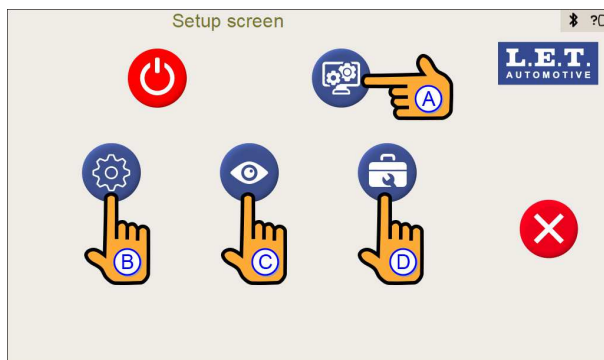

The **Setup** screen allows the operator to enter the **Computer configuration** screen **(A)**, **Settings program** screen **(B)**, **Verification** screen **(C)**, **Calibration** screen **(D)** and the **Power** screen.

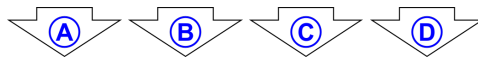

Tap on the **(A)** button above to enter the **Computer configuration** screen.

Tap on the **(B)** button above to enter the **Settings program** screen.

Tap on the **(C)** button above to enter the **Verification** screen.

Tap on the **(D)** button above to enter the **Calibration** screen.

**Related tasks**[Setup screen](#) (pg. 215)**Computer configuration screen**

**Note:** The screen may have a different appearance depending on the customer's specific implementation. The access rights to the different menus on the screen are hierarchical and depend on the applied login level, which is password protected.

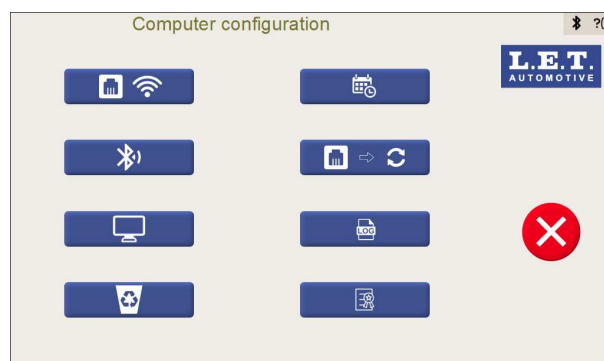

The **Computer configuration** screen allows the operator to access date/time settings, licensing information and communication related parameters.

**Related tasks**[Computer configuration screen](#) (pg. 221)**Settings program screen**

**Note:** The screen may have a different appearance depending on the customer's specific implementation. The access rights to the different menus on the screen are hierarchical and depend on the applied login level, which is password protected.

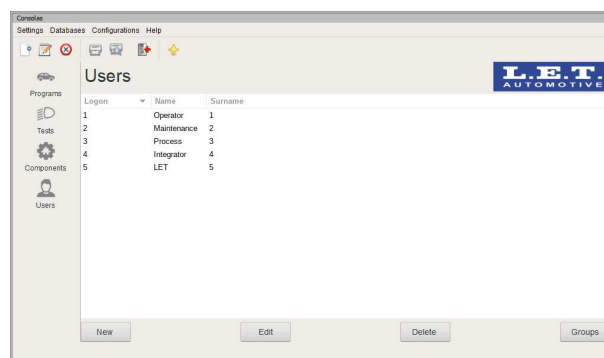
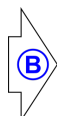

The **Settings program** screen allows the operator to edit the Luminoscope® databases. The settings program contains a collection of parameters used in the Luminoscope®. These parameters define the vehicles (also called programs), headlamps (also called tests), components and users.

## Verification screen

**Note:** The screen may have a different appearance depending on the customer's specific implementation. The access rights to the different menus on the screen are hierarchical and depend on the applied login level, which is password protected.

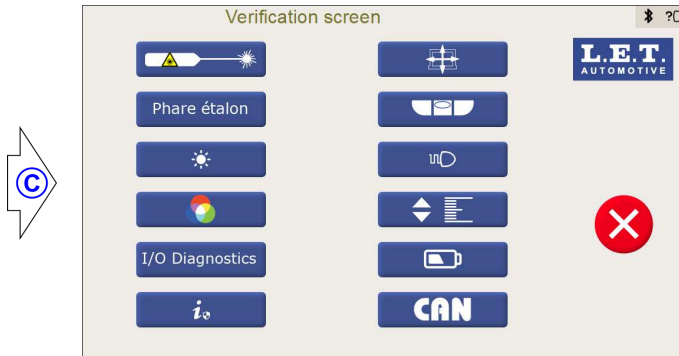

The **Verification** screen allows the operator to access tools for verification of the calibration and operations of the Luminoscope®.

## Calibration screen

**Note:** The screen may have a different appearance depending on the customer's specific implementation. The access rights to the different menus on the screen are hierarchical and depend on the applied login level, which is password protected.

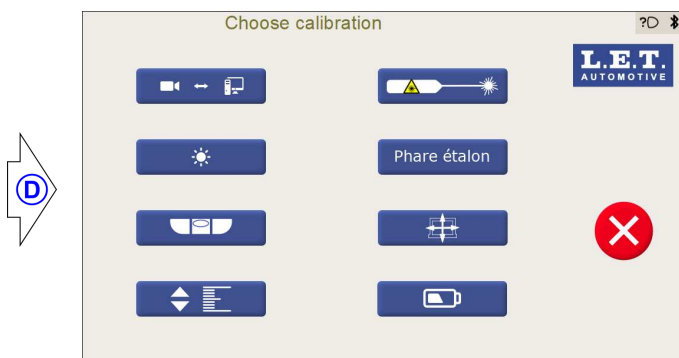

The **Calibration** screen allows the operator to access tools for calibration of different components of the Luminoscope®.

# 9 System screen

The **System** screen acts as a hub for a number of functions. Among others, it gives access to the following functions which are thoroughly explained in the upcoming chapters:

- Turn off or restart the Luminoscope®.
- Language selection.
- Setup menu.
- Overview of technical data of the Luminoscope®.
- Reprint the last test result.
- Recall the recent test results.
- Data import and export using a *USB* stick.

When powered-up, the Luminoscope® displays the **Program selection** screen. Follow the navigation sequence below to reach the **System** screen.

1. Tap on the **System** button 1 on the **Program selection** screen.



**Note:** The screen may have a different appearance depending on the customer's specific implementation.

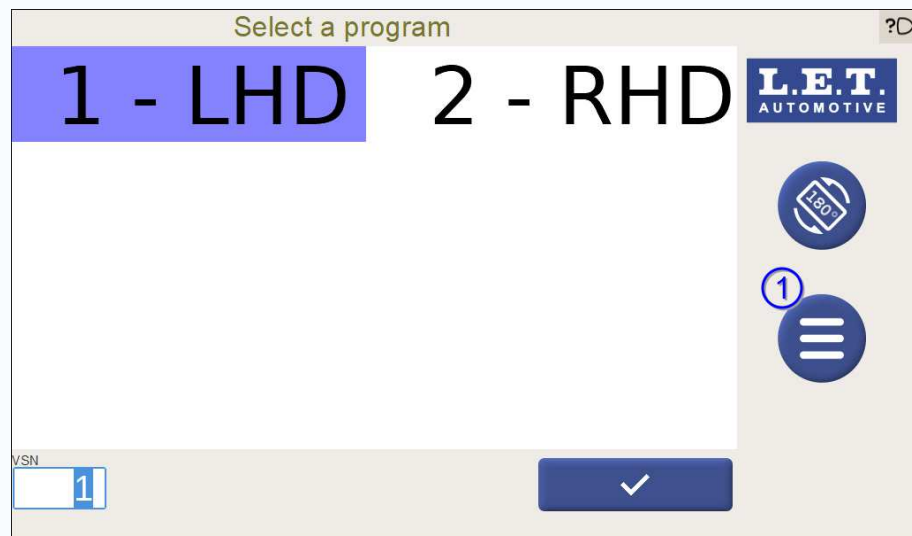

Figure 153: **Program selection** screen with **System** button

The **System** screen is now displayed.

2. Choose one of the options on the **System** screen and tap on the corresponding button.



Figure 154: System screen

#	Button	Description
2	<b>Power</b> button	Turn off or restart the Luminoscope®
3	<b>Language</b> button	Select the language for the user interface.
4	<b>Setup</b> button	Enter the <b>Setup login</b> screen.
5	<b>Test program</b> button	Enter the <b>Beam selection</b> screen to execute a test cycle without communication (if applicable).
6	<b>System information</b> button	Overview of technical data of the Luminoscope®.
7	<b>Print last result</b> button	Reprint the last test result.
8	<b>Recall recent results</b> button	Query the most recent test results and reprint if needed.
9	<b>Abort</b> button	Return to the <b>Program selection</b> screen.
10	<b>USB</b> button	Import/export data using a USB stick.

**Note:**

- Button 7 is only functional when a ticket printer is connected to the Luminoscope®.
- The **USB** button 10 appears when an **USB** stick is inserted in the connector plate of the Luminoscope®.

## 9.1 Luminoscope® turn off or restart

The **Power** button on the **System** screen gives access to the menu to turn off or restart the Luminoscope®.

1. Tap on the **Power** button 1 on the **System** screen.

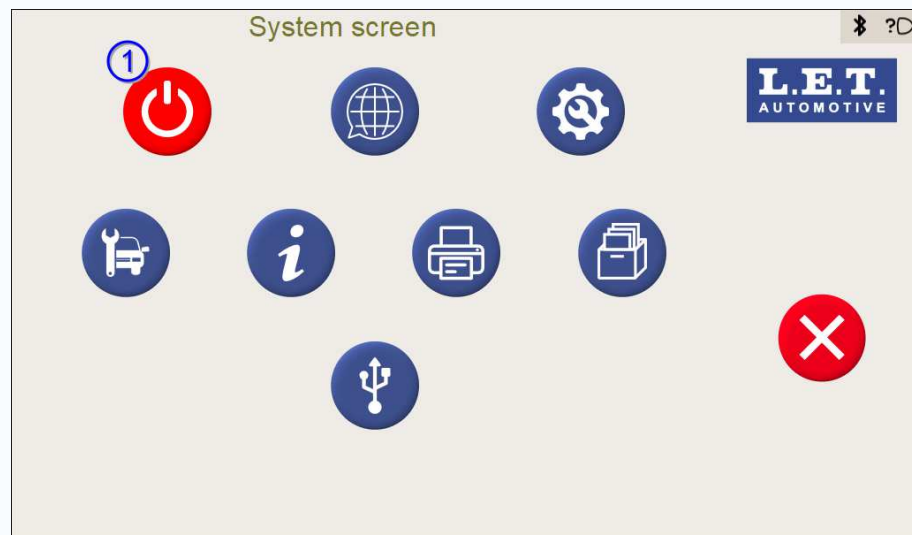

Figure 155: **System** screen with **Power** button

The **Power** screen is now displayed.

2. Choose one of the options on the **Power** screen and tap on the corresponding button.

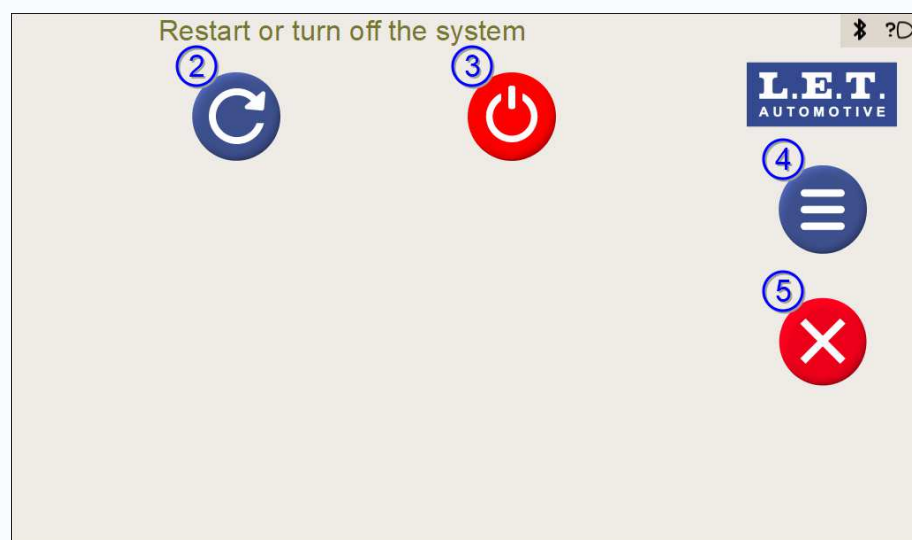

Figure 156: **Power** screen

#	Button	Description
2	<b>Restart</b> button	Restart the Luminoscope®.
3	<b>Turn Off</b> button	Turn off the Luminoscope®.
4	<b>System</b> button	Access the <b>System</b> screen.
5	<b>Abort</b> button	Return to the <b>Program selection</b> screen.

**Related information**[Power management](#) (pg. 55)

## 9.2 Language selection

The **Language** button on the **System** screen gives access to the menu to choose the language of the user interface of the Luminoscope®.

1. Tap on the **Language** button 1 on the **System** screen.

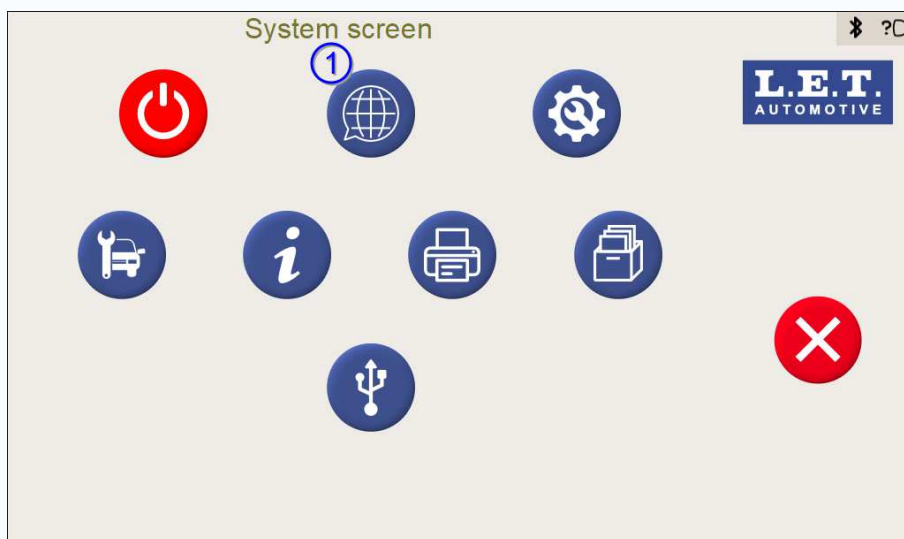

Figure 157: **System** screen with **Language** button

The **Language selection** screen is now displayed.

2. Choose one of the options on the **Language selection** screen and tap on the corresponding button.



**Note:** The screen may have a different appearance depending on the customer's specific implementation.

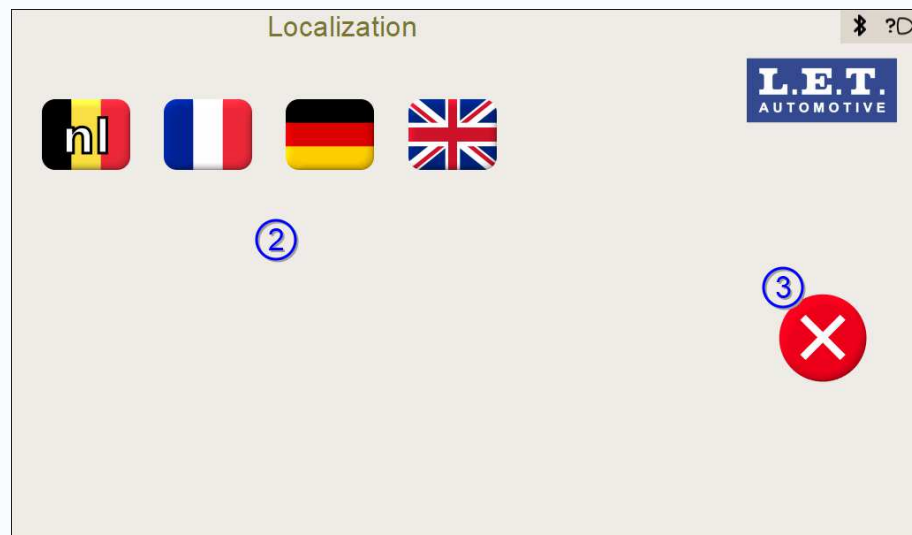

Figure 158: **Language selection** screen

#	Button	Description
2	<b>Language selection</b> button	Select a language for the user interface.
3	<b>Abort</b> button	Return to the <b>System</b> screen.

3. Reboot the Luminoscope® to ensure that all the system components display the newly selected language.

#### Related tasks

Luminoscope® [turn off or restart](#) (pg. 192)

## 9.3 System information

The **System information** button on the **System** screen provides access to technical data of the current setup of the Luminoscope® and can be useful for consult details about the configuration and status of the Luminoscope®.

1. Tap on the **System information** button 1 on the **System** screen.

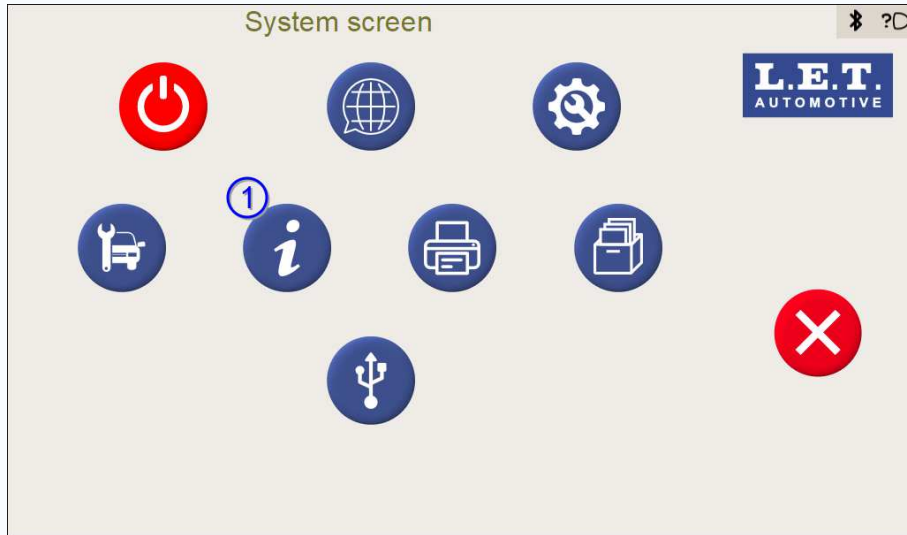

Figure 159: System screen with System information button

The System information screen is now displayed.

2. Consult the information on the System information screen or tap on the Abort button.



**Note:** The screen may have a different appearance depending on the customer's specific implementation.



Figure 160: System information screen

#	Button	Description
1	Abort button	Return to the System screen.



**Note:** The Luminoscope® stores its program and configuration details in the internal memory. Besides, it also uses the memory for storing test results

and activity logs. The internal memory use is displayed at the bottom of the list along with the warning limit.

Depending on the use of the Luminoscope®, the internal memory may become exhausted. Avoid it by purging it on demand via the web interface or by using the corresponding export procedures linked below.

## 9.4 Reprint last test result

The **Print last result** button on the **System** screen enables the user to reprint the last test result of the Luminoscope®.



**Note:** The **Print last result** button only has an associated function when a ticket printer is connected to the Luminoscope®.

Tap on the **Print last result** button 1 on the **System** screen.

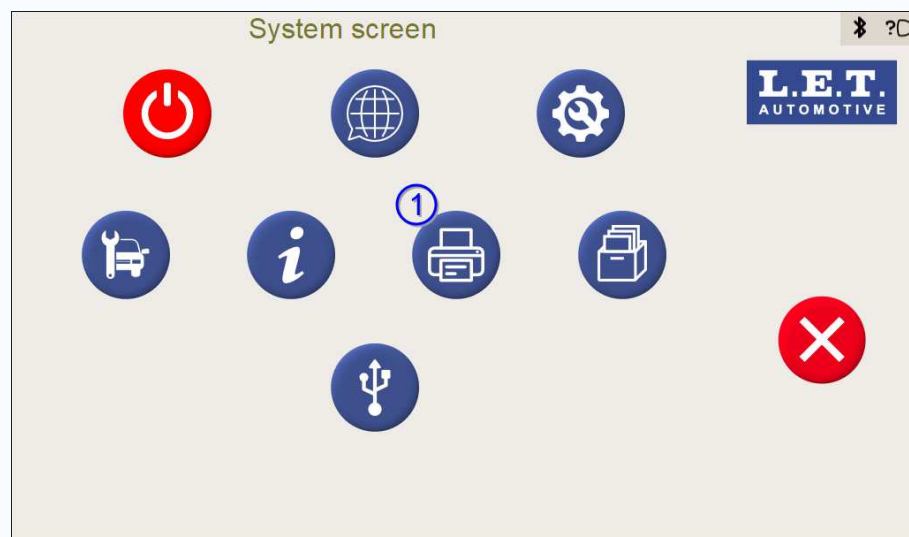

Figure 161: **System** screen with **Print last result** button

A duplicate of the last test result is printed on the ticket printer.

### Related information

[Test report as printed ticket](#) (pg. 99)

## 9.5 Recall recent test results

The **Recall recent results** button on the **System** screen enables the user to scroll through the recent test results of the Luminoscope® and to reprint the ticket of the selected test result.

1. Tap on the **Recall recent results** button 1 on the **System** screen.

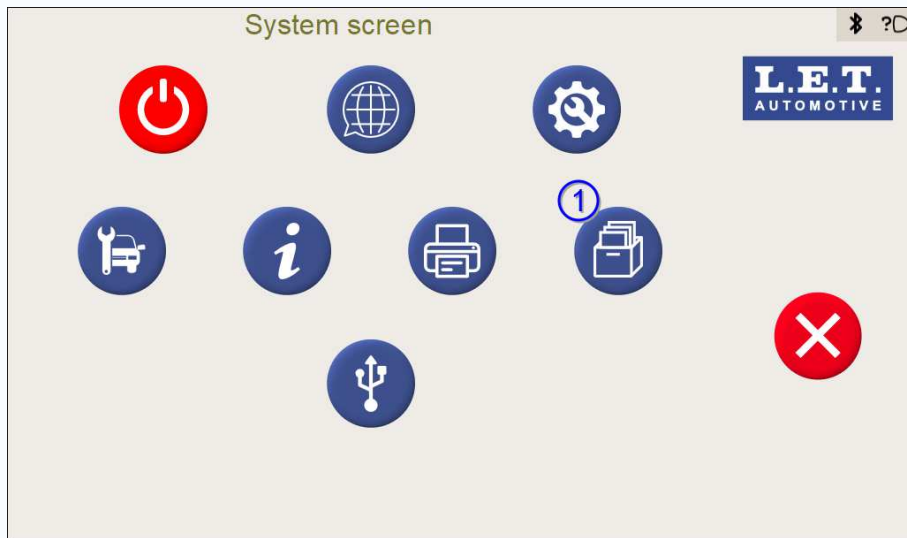

Figure 162: **System** screen with **Recall recent results** button

The **Recent results** screen is now displayed.

2. Choose one of the options on the **Recent results** screen and tap on the corresponding button.

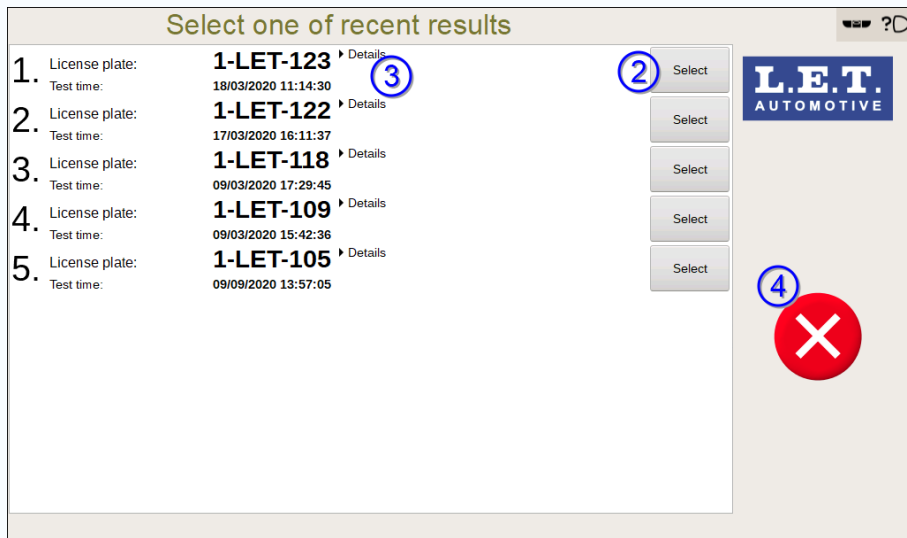

Figure 163: **Recent results** screen

#	Button	Description
2	<b>Select</b> button	Select one of the results to be reprinted. A duplicate of the selected test result is printed on the ticket printer.
3	<b>Details</b> button	Show or hide the measured values of the selected result.
4	<b>Abort</b> button	Return to the <b>System</b> screen.



**Note:** Button 2 is only functional when a ticket printer is connected to the Luminoscope®.

#### Related information

[Test report as printed ticket](#) (pg. 99)

## 9.6 Import / export of data via **USB** stick

The **USB** button on the **System** screen gives access to the **USB** screen.



**Note:** The **USB** button on the **System** screen appears when a **USB** stick is inserted in the connector plate of the Luminoscope®.



**Attention:** Only **FAT-32**-formatted **USB** sticks are recognized. Specifically, **NTFS** format is not supported.

The **USB** screen acts as a hub for a number of functions. Among others, it gives access to the following functions which are thoroughly explained in the upcoming chapters:

- Export of a configuration file from the Luminoscope® to a **USB** stick.
- Export of test result files from the Luminoscope® to a **USB** stick.
- Export of log files from the Luminoscope® to a **USB** stick.
- Export of the configuration of vehicles (programs) and headlamps (tests) to a **USB** stick.
- Import of configuration files from a **USB** stick to the Luminoscope®.
- Import of a software update from a **USB** stick to the Luminoscope®.
- Import of a new license token configuration from a **USB** stick to the Luminoscope®.
- Import of the configuration of vehicles (programs) and headlamps (tests) from a **USB** stick to the Luminoscope®.

1. Insert a **USB** stick in the connector plate of the Luminoscope®.



**Note:** If a **USB** stick is inserted but is not accepted, the screen becomes blank with a single **Abort** button available. In such a case, remove the **USB** stick and press the **Abort** button.

2. Tap on the **USB** button 1 on the **System** screen.

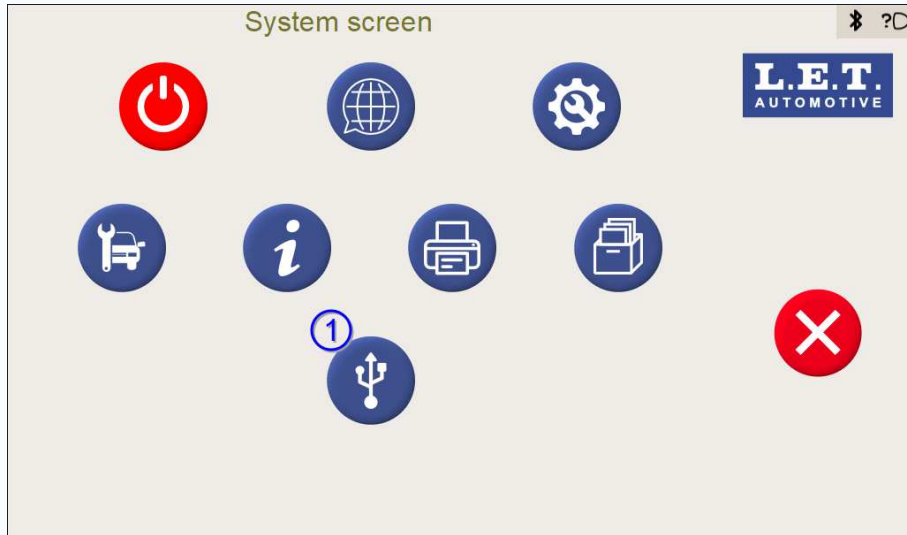

Figure 164: **System** screen with **USB** button

The **USB** screen is now displayed.

**Note:** The screen may have a different appearance depending on the customer's specific implementation.

3. Choose one of the options on the **USB** screen and tap the corresponding button.

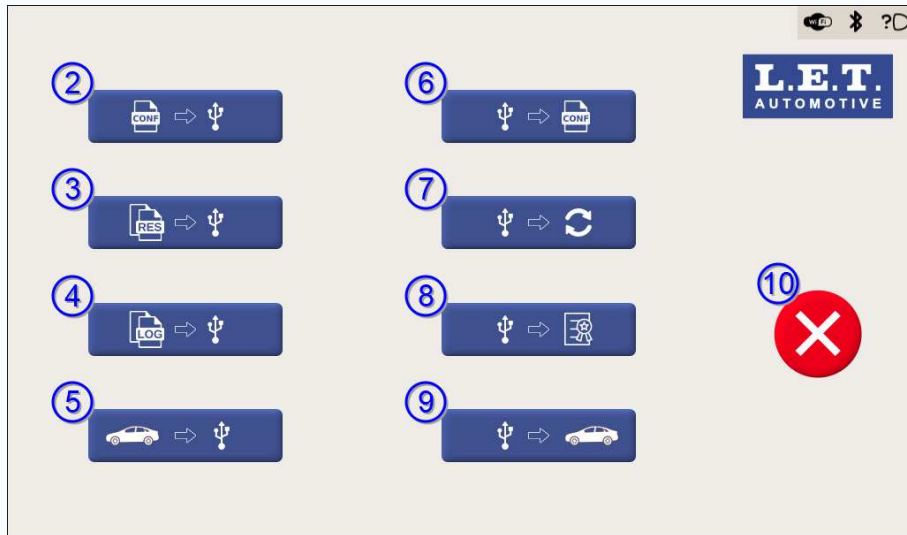

Figure 165: **USB** screen

#	Button	Description
2	<b>Export configuration</b> button	Export of a configuration file from the Luminoscope® to a <i>USB</i> stick.
3	<b>Export results</b> button	Export of test result files from the Luminoscope® to a <i>USB</i> stick.
4	<b>Export logs</b> button	Export of log files from the Luminoscope® to a <i>USB</i> stick.

#	Button	Description
5	<b>Export vehicles and headlamps</b> button	Export of the configuration of vehicles (programs) and headlamps (tests) to a <i>USB</i> stick.
6	<b>Import configuration</b> button	Import of the configuration files from a <i>USB</i> stick to the Luminoscope®.
7	<b>Import update</b> button	Import of a software update from a <i>USB</i> stick to the Luminoscope®.
8	<b>Import license token</b> button	Import of a new licence token configuration from a <i>USB</i> stick to the Luminoscope®.
9	<b>Import vehicles and headlamps</b> button	Import of the configuration of vehicles (programs) and headlamps (tests) from a <i>USB</i> stick to the Luminoscope®.
10	<b>Abort</b> button	Return to the <b>System</b> screen.



**Note:** Some of the export/import operations require credentials. An overview of the applicable credentials can be found in the **Setup** screen chapter.

#### Related tasks

[Setup screen](#) (pg. 215)

### 9.6.1 Export operations: Luminoscope® to *USB* stick

All the following operations export different data from the Luminoscope® and write them to a *USB* stick.



**Note:** Many of the below described operations can be also achieved via the Luminoscope® web interface. Please consider using that alternative method for more general and interoperable results.

#### Related information

[Web interface](#) (pg. 241)

#### 9.6.1.1 Export of a configuration file

The **Export configuration** button on the **USB** screen can be used to export the Luminoscope® configuration to a *USB* stick.



**Note:** The configuration file is also called the backup file.



**Attention:** Each Luminoscope® has its unique backup file(s). The backup file(s) can only be applied to the same Luminoscope®. The files are not interchangeable between different Luminoscope® units.

Starting from the **USB** screen.

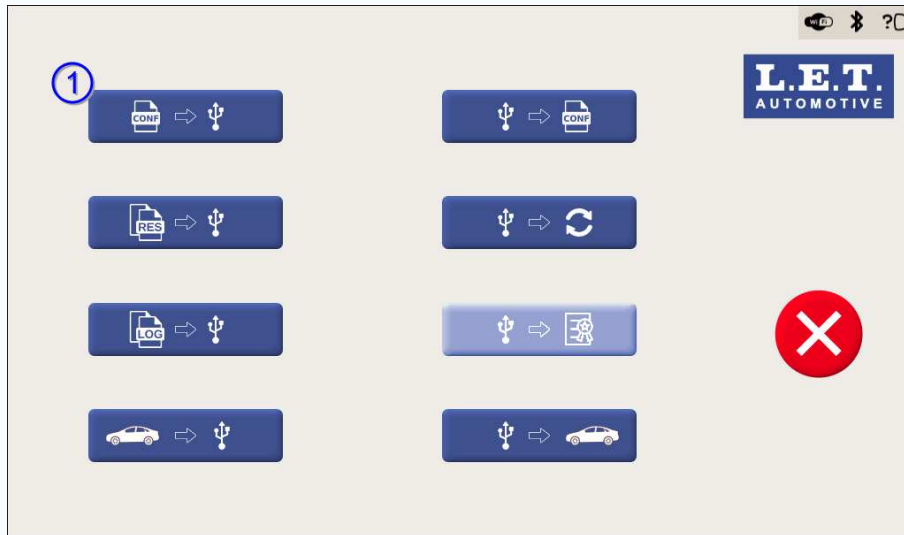

Figure 166: **USB** screen with **Export configuration** button

1. Tap on the **Export configuration** button 1 on the **USB** screen. The **Credentials** screen is now displayed.



Figure 167: **Credentials** screen for **Export configuration** operation

2. Enter your credentials 2 and tap on the **OK** button 3. Alternatively tap on the **Cancel** button 4 to return to the **USB** screen.



**Note:** An overview of the applicable credentials can be found in the **Setup** screen chapter.

The configuration file (backup from the Luminoscope®) is exported to the *USB* stick. During the operation the screen below is displayed:

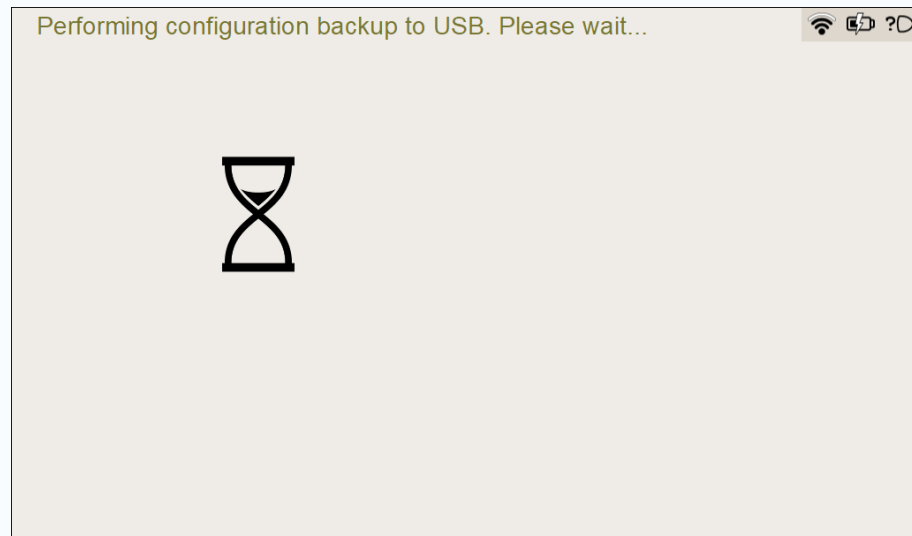

Figure 168: **Export configuration** operation progress

Once the **Export configuration** operation has finished, the **USB** screen is displayed again.

3. Remove the *USB* stick from the socket of the Luminoscope® connector panel and connect it to a PC.
4. Browse the *USB* stick and open its root folder.

The **Export configuration** operation has created a main Luminoscope® folder on the *USB* stick, if it didn't exist yet.

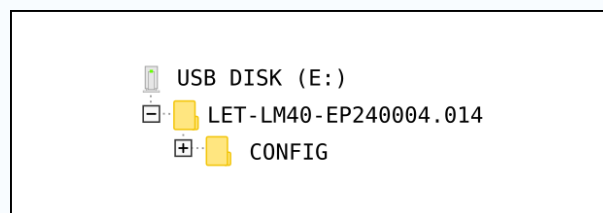

Figure 169: Main Luminoscope® folder on the *USB* stick

The syntax of the main Luminoscope® folder name follows the format `LET-LM40-EPxxxxxxx.xxx` where the section `EPxxxxxxx.xxx` represents the unique serial number of the optical block.

The **Export configuration** operation has also created a `CONFIG` folder under the main Luminoscope® folder, if it didn't exist yet. Each **Export configuration** operation creates a GZIP file in the `CONFIG` folder including the exported configuration files.

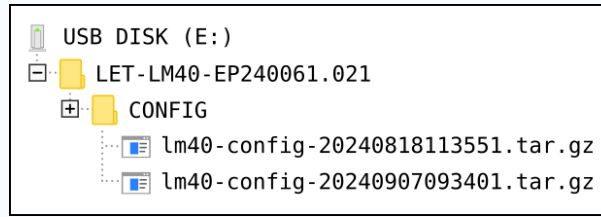

Figure 170: Folder structure on the USB stick

The naming of the exported configuration file follows the format `lm40-config-yyyymmddhhmmss.zip` where the section `yyyymmddhhmmss` is calculated upon the file creation timestamp as explained below.

Field content	Format	Example	Explanation
year	<i>yyyy</i>	2019	4-digit format.
month	<i>mm</i>	09	2-digit format, left zero-padded.
day	<i>dd</i>	24	2-digit format, left zero-padded.
hour	<i>hh</i>	09	2-digit format, left zero-padded.
minutes	<i>mm</i>	38	2-digit format, left zero-padded.
seconds	<i>ss</i>	35	2-digit format, left zero-padded.
Extension	<i>.tar.gz</i>	.tar.gz	Compressed archive file extension.



**Note:** Each time the **Export configuration** operation is completed, a new configuration file (a backup) is added to the `CONFIG` folder.

### 9.6.1.2 Export of test result files

The **Export results** button on the **USB** screen can be used to export the Luminoscope® test result files to an *USB* stick.

After the Luminoscope® has stored the test result files on the *USB* stick, the user is offered with the option of completely deleting the exported test results from the Luminoscope® memory. This means they are no longer available for any other use in the Luminoscope®.

Starting from the **USB** screen.

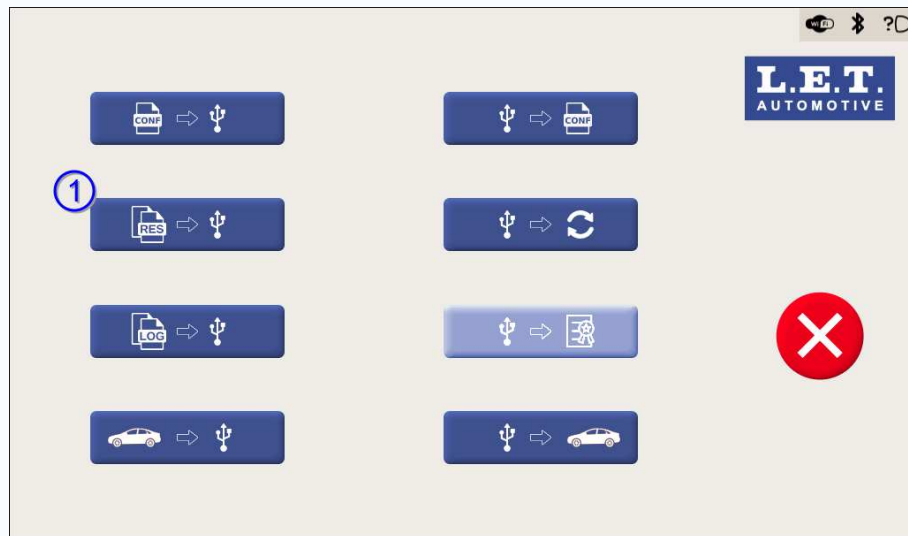

Figure 171: **USB** screen with **Export results** button

1. Tap on the **Export results** button 1 on the **USB** screen.

The test result files are immediately exported to the *USB* stick. During the operation the following screen is displayed:

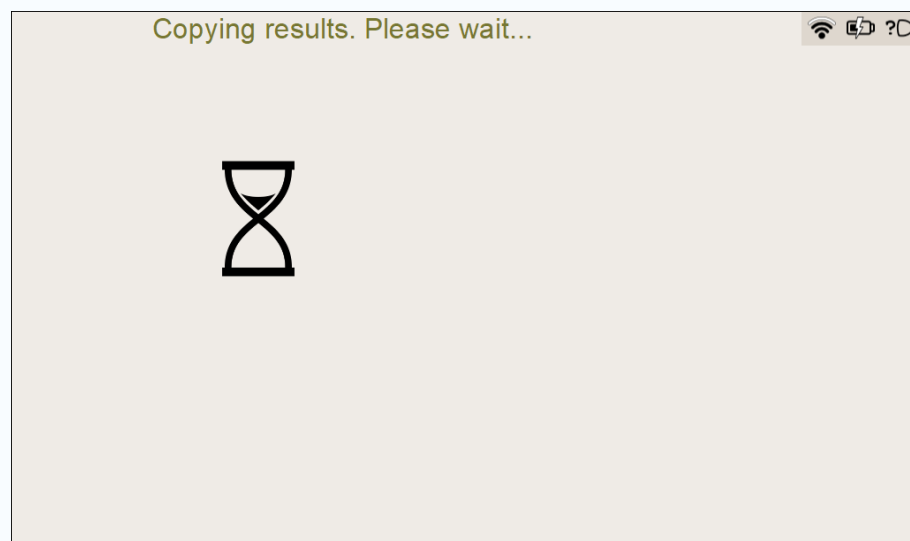

Figure 172: **Export results** operation progress

Once the **Export results** operation has finished, the *USB* stick can be safely removed and the following screen appears:

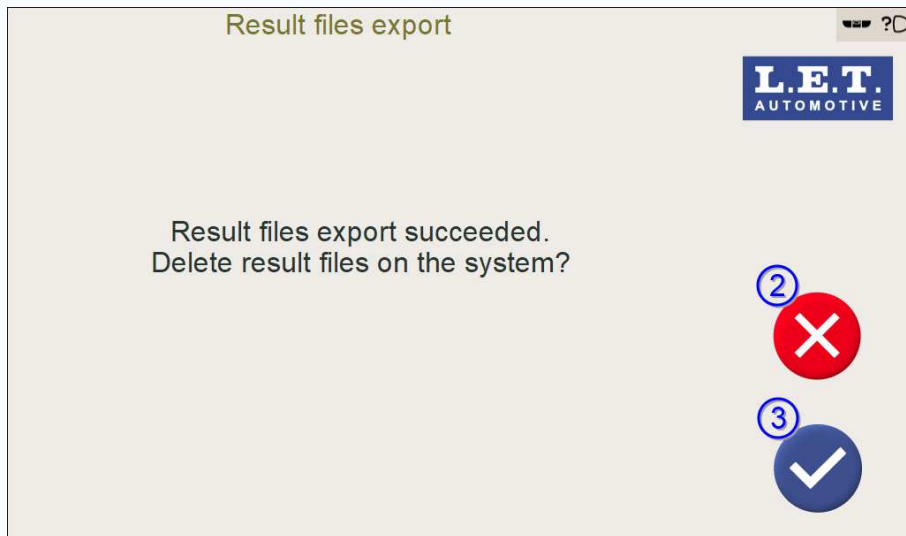

Figure 173: Removing test result file

After the Luminoscope® has stored the test result files on the *USB* stick, the user is offered with the option of completely deleting the exported test results from the Luminoscope® memory. This means they are no longer available for any other use in the Luminoscope®.



**Note:** If there were no remaining test result files to export in the Luminoscope® memory, an informative screen is displayed. After pressing the **Abort** button, the screen displays the **USB** screen again.

2. Tap on the **Validation** button 3 to remove the test result files from the Luminoscope® memory or tap on the **Abort** button 2 in case the result files should be kept.

When removed, the result files will not be available anymore and the Luminoscope® displays the **USB** screen.

3. Remove the *USB* stick from the socket of the Luminoscope® connector panel and connect it to a PC.
4. Browse the *USB* stick and open its root folder.

The **Export results** operation has created a main Luminoscope® folder on the *USB* stick, if it didn't exist yet.

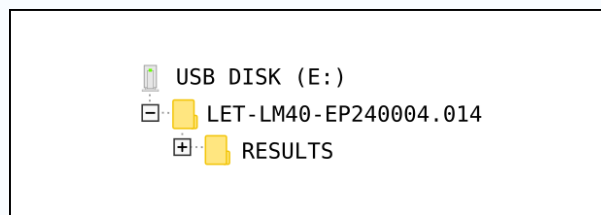

Figure 174: Main Luminoscope® folder on the *USB* stick

The syntax of the main Luminoscope® folder name follows the format `LET-LM40-EPxxxxxx.xxx` where the section `EPxxxxxx.xxx` represents the unique serial number of the optical block.

The **Export results** operation has also created a **RESULTS** folder under the main Luminoscope® folder, if it didn't exist yet. Each **Export results** operation creates a **ZIP** file in the **RESULTS** folder including the exported result files.

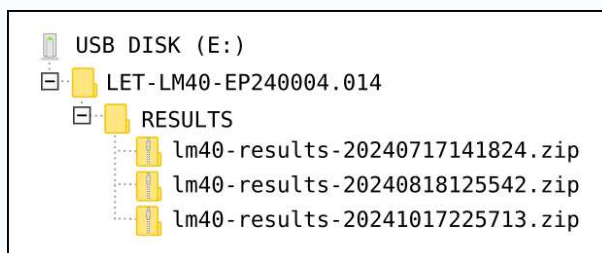

Figure 175: Folder structure on the USB stick

The naming of the exported test result file follows the format `lm40-results-yyyymmddhhmmss.zip` where the section `yyyymmddhhmmss` is calculated upon the file creation timestamp as explained below.

Field content	Format	Example	Explanation
Year	<i>yyyy</i>	2020	4-digit format.
Month	<i>mm</i>	03	2-digit format, left zero-padded.
Day	<i>dd</i>	17	2-digit format, left zero-padded.
Hour	<i>hh</i>	09	2-digit format, left zero-padded.
Minutes	<i>mm</i>	52	2-digit format, left zero-padded.
Seconds	<i>ss</i>	04	2-digit format, left zero-padded.
Extension	<i>.zip</i>	<i>.zip</i>	Compressed archive file extension.

The exported test result file has an internal structure which includes a **pdf** folder with a number of **PDF** test cycle report files. Each of them is the product of a single test cycle.

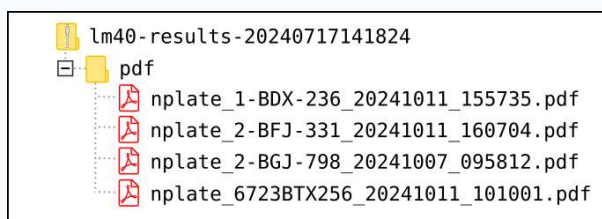

Figure 176: Exported test result file structure including **PDF** test cycle report files

The naming of each **PDF** test cycle report file follows the format `nplate_licenseplate_yyyymmdd-hhmmss.pdf` including the file creation timestamp among other fields as described below.

Field content	Format	Example	Explanation
File identifier	<i>nplate</i>	nplate	Constant string for identification of the file contents.
License plate	<i>licenseplate</i>	1-BDX-236	Registration plate of the corresponding vehicle. If the number was not defined during the test, it is substituted by <i>unknown</i> .
Year	<i>yyyy</i>	2020	4-digit format.

Field content	Format	Example	Explanation
Month	<i>mm</i>	03	2-digit format, left zero-padded.
Day	<i>dd</i>	17	2-digit format, left zero-padded.
Hour	<i>hh</i>	09	2-digit format, left zero-padded.
Minutes	<i>mm</i>	52	2-digit format, left zero-padded.
Seconds	<i>ss</i>	04	2-digit format, left zero-padded.
Extension	<i>.pdf</i>	.pdf	File extension.

5. Open the desired test cycle report file.



**Note:** The test cycle report file may have a different appearance depending on the customer's specific implementation. Consequently, the example underneath may differ from your Luminoscope® configuration.

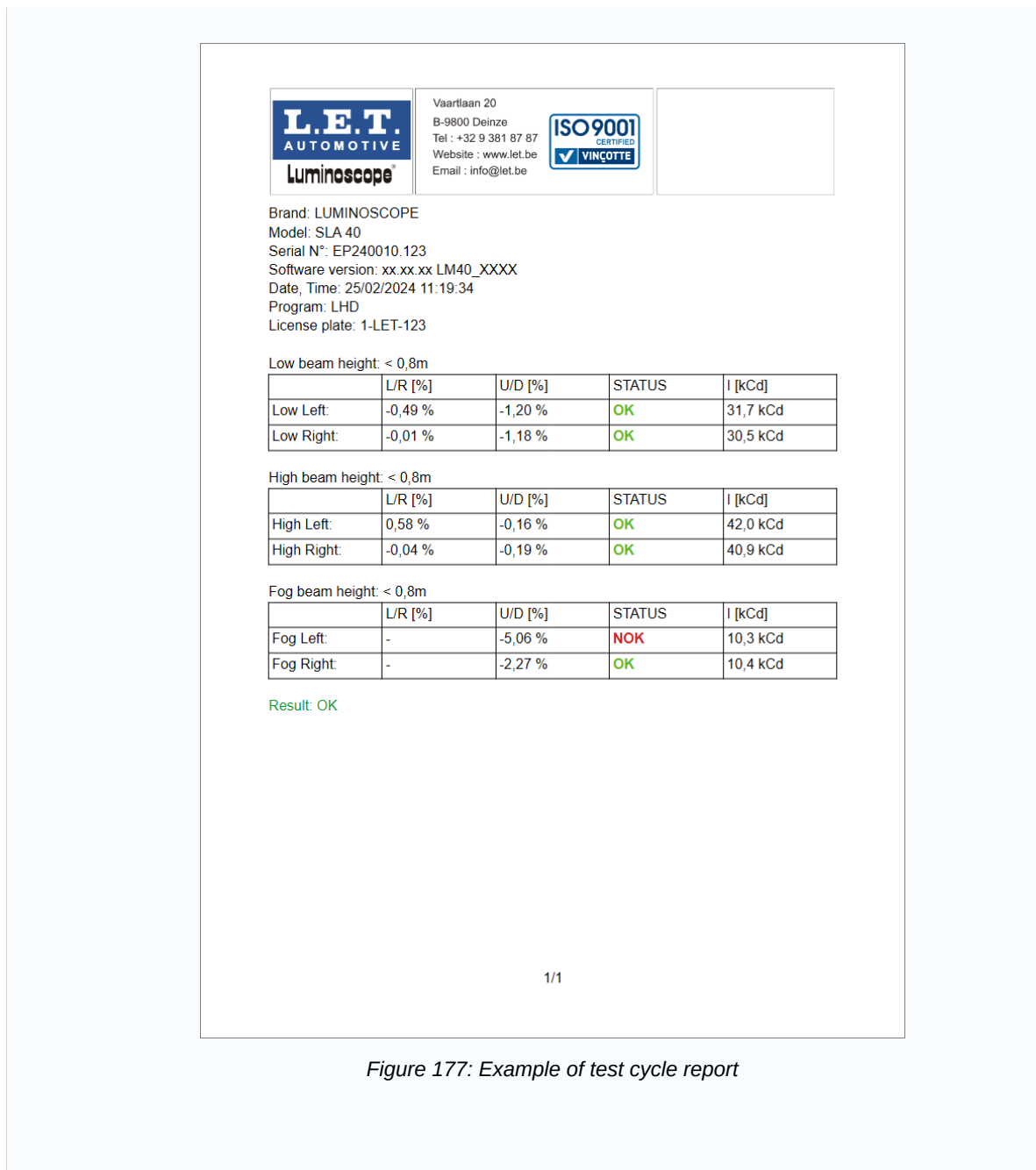

Figure 177: Example of test cycle report

### 9.6.1.3 Export of log files

The **Export logs** button on the **USB** screen can be used to export the Luminoscope® log files to a **USB** stick.

There are two categories of files which are grouped into log files:

- Log files in text format containing a number of timestamped lines describing events, related to the activity of the Luminoscope®. The information in these log files can be useful for tracking or diagnostic tasks. It may be interesting to store or archive them for future reference. The content of these log files is not intended to be used by regular users and is continuously generated.
- Headlamp images as obtained from the camera of the Luminoscope®, so as screenshots of its user interface. They are captured simultaneously along with some diagnostic files each time the user taps on the *LET Automotive logo* on the touch screen and may be useful for future reference.

Starting from the **USB** screen.

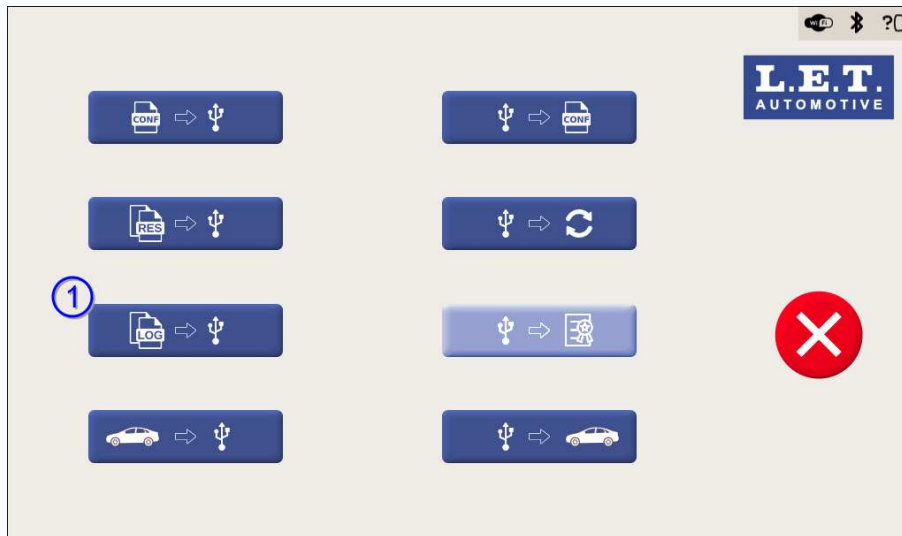

Figure 178: **USB** screen with **Export logs** button

1. Tap on the **Export logs** button 1 on the **USB** screen.

All the different log files are immediately exported to the *USB* stick. During the operation the following screen is displayed:

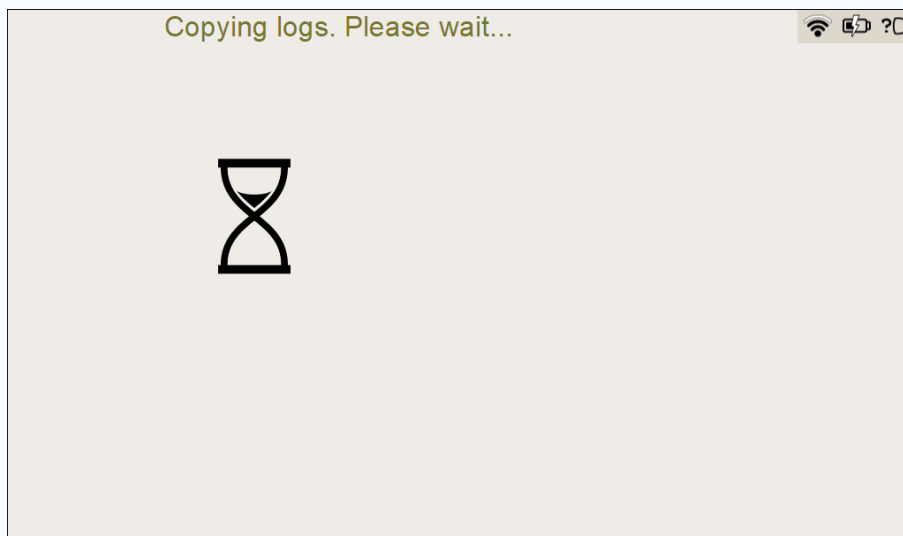

Figure 179: **Export logs** operation progress

Once the **Export logs** operation has finished, the *USB* stick can be safely removed and the following screen is displayed:

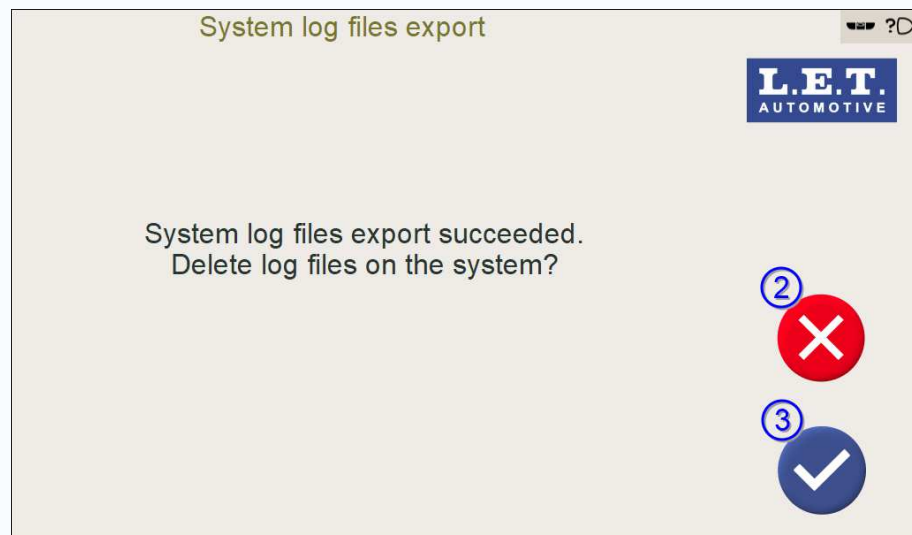

Figure 180: Delete log files from the Luminoscope®

After the Luminoscope® has stored the log files on the *USB* stick, the user is offered with the option of completely deleting the exported log files from the Luminoscope®.

2. Tap on the **Validation** button 3 to remove the log files from the Luminoscope® or tap on the **Abort** button 2 in case the log files should be kept.
3. Remove the *USB* stick from the socket of the Luminoscope® connector panel and connect it to a PC.
4. Browse the *USB* stick and open its root folder.

The **Export logs** operation has created a main Luminoscope® folder on the *USB* stick if it didn't previously exist.

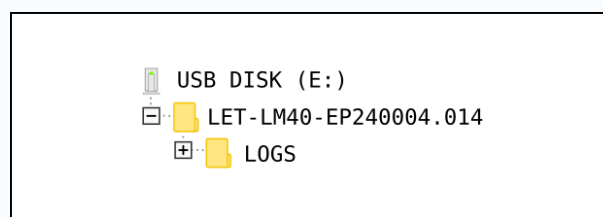

Figure 181: Main Luminoscope® folder on the *USB* stick

The syntax of the main Luminoscope® folder name follows the format `LET-LM40-EPxxxxxxx.xxx` where the section `EPxxxxxxx.xxx` represents the unique serial number of the optical block.

The **Export logs** operation has also created a `LOGS` folder under the main Luminoscope® folder, if it didn't exist yet. The **Export logs** operation creates a number of files and folders under the `LOGS` folder, depending on their availability.

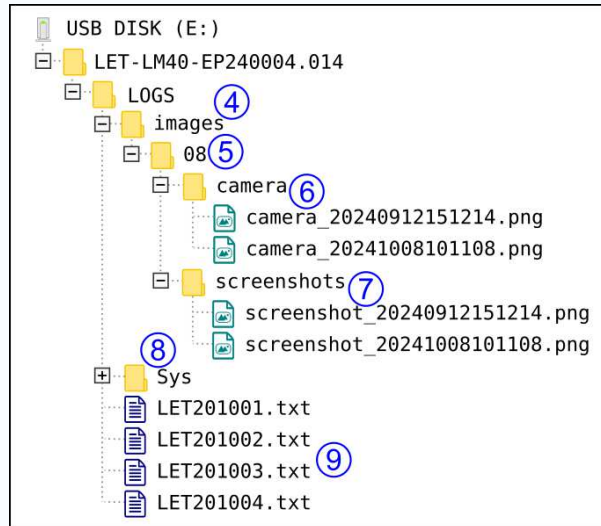

Figure 182: Folder structure on the USB stick

#	Name	Explanation
4	images	This folder has been created (if it didn't exist yet) if there were camera images and screenshots of the user interface in the Luminoscope® memory.
5	08	This subfolder has been created (if it didn't exist yet), labelled with the (zero-padded) current day of the month of the <b>Export logs</b> operation. Successive applications of the <b>Export logs</b> operation may create similar folders.
6	camera	This subfolder has been created (if it didn't exist yet), if there were any pictures to be exported. It contains a variable number of <i>PNG</i> files, each of them generated by the tapping on the <i>LET Automotive logo</i> of the Luminoscope® screen and containing a screenshot of the status of the device camera. Successive applications of the <b>Export logs</b> operation may add more pictures to this folder. The name of the picture includes the file creation timestamp.
7	screenshots	This subfolder has been created (if it didn't exist yet), if there were any pictures to be exported. It contains a variable number of <i>PNG</i> files, each of them generated by the tapping on the <i>LET Automotive logo</i> of the Luminoscope® screen and containing a screenshot of the status of the user interface of the device. Successive applications of the <b>Export logs</b> operation may add more pictures to this folder. The name of the picture includes the file creation timestamp.
8	Sys	This subfolder has been created (if it didn't exist yet), if there were diagnostic files to be exported. It contains useful diagnosing information and it is not intended for regular users but may be eventually requested by LET service technicians. Successive applications of the <b>Export logs</b> operation update the content of this folder.

#	Name	Explanation
9	log files	Text files containing a number of timestamped lines describing events related to the activity of the Luminoscope®. Each file is named with a timestamp and contains the events happening on that date. Successive applications of the <b>Export logs</b> operation may then either append to existing files or add new files to the list.

#### 9.6.1.4 Export of a configuration file of vehicles and headlamps

The **Export vehicles and headlamps** button on the **USB** screen can be used to export a specific part of the Luminoscope® configuration to a *USB* stick. This operation specifically exports the vehicles (*programs*) and headlamps (*tests*) with all their related parameters from the database, while excluding any other configuration parameter.



**Attention:** This feature is not available for the current access level. Please refer to a user who has the necessary permissions if the feature is required.

### 9.6.2 Import operations: *USB* to Luminoscope®

All the following operations read different data from a *USB* stick and write them to the Luminoscope®.

#### 9.6.2.1 Import of a configuration file

The **Import configuration** button on the **USB** screen can be used to import a configuration file (that was previously stored on a *USB* stick) to the Luminoscope®. The **Import configuration** operation allows restoring the Luminoscope® to a previous status for which an **Export configuration** operation was done.



**Attention:** This feature is not available for the current access level. Please refer to a user who has the necessary permissions if the feature is required.

#### 9.6.2.2 Software update from a *USB* stick

The **Import update** button on the **USB** screen can be used to update the system software from a properly crafted *USB* stick. This functionality allows the user to apply, under remote supervision by LET technicians, specific small patches for particular parts of the system in order to modify its behavior or configuration details.



**Attention:** This feature is not available for the current access level. Please refer to a user who has the necessary permissions if the feature is required.

#### 9.6.2.3 Import of a *license token file*

The **Import license token** button on the **USB** screen can be used to import a new *license token file* from a *USB* stick to the *USB License Dongle* in the Luminoscope®.



**Attention:** This feature is not available for the current access level. Please refer to a user who has the necessary permissions if the feature is required.

#### 9.6.2.4 Import of a configuration file of vehicles and headlamps

The **Import vehicles and headlamps** button on the **USB** screen can be used to import a specific part of the Luminoscope® configuration that was previously stored on a *USB* stick to the Luminoscope® memory. This operation specifically imports the vehicles (*programs*) and headlamps (*tests*) with all their related parameters from the database, while excluding any other configuration parameter.



**Attention:** This feature is not available for the current access level. Please refer to a user who has the necessary permissions if the feature is required.

---

# 10 Setup screen

---

The **Setup** screen acts as a hub for a number of functions. Among others, it gives access to the following functions which are thoroughly explained in the upcoming chapters:

- Turn off or restart the Luminoscope®.
- Computer configuration of the Luminoscope®.
- Settings program menu.
- Verification menu.
- Calibration menu.

When powered up, the Luminoscope® displays the **Program selection** screen. Follow the navigation sequence below for reaching the **Setup** screen.

1. Tap on the **System** button 1 on the **Program selection** screen.



**Note:** The screen may have a different appearance depending on the customer's specific implementation.

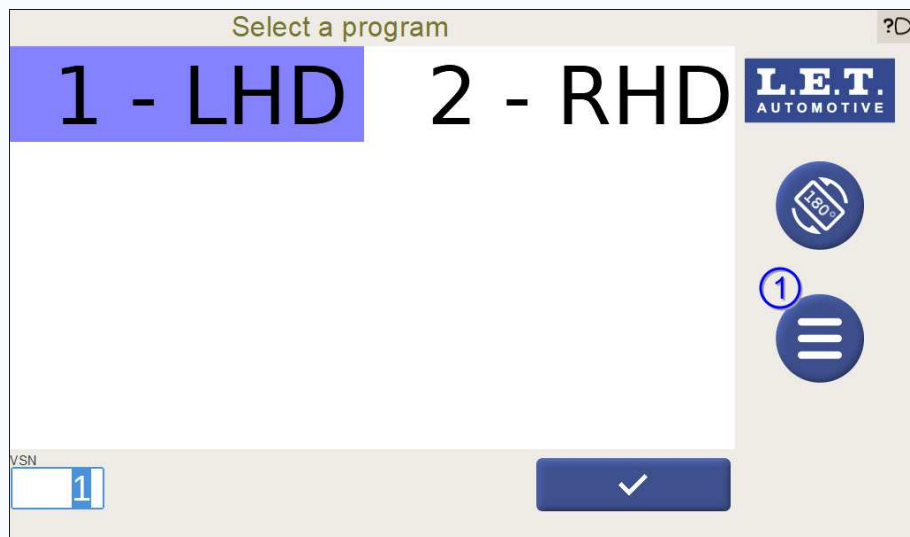

Figure 183: **Program selection** screen with **System** button

The **System** screen is now displayed.

2. Tap on the **Setup** button 2 on the **System** screen.

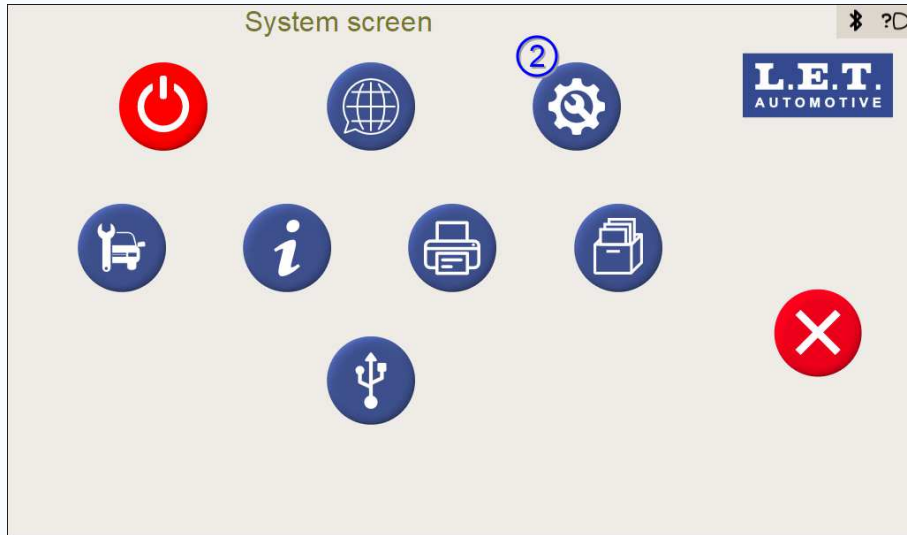

Figure 184: System screen with Setup button

The Setup login screen is now displayed.

3. Enter your credentials 3 and tap on the Validation button 4. Alternatively tap on the Abort button 5 to return to the System screen.

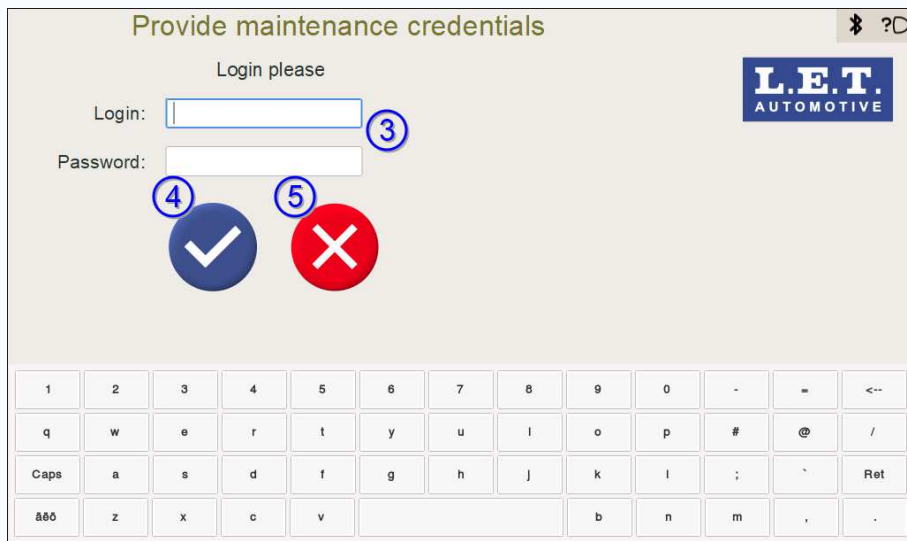

Figure 185: Setup login screen

The access to the different menus and their options is hierarchical and depends on the access rights of each login, which is identified with a password as follows:

Level	Login	Password	Description
Operator	1	1234	Operator staff working with the equipment.
Maintenance	2	Confidential	Maintenance staff and production leaders have access to most common functions except data related with vehicles and headlamps.
Process	3	Confidential	Process staff have additional access to data related to vehicles and headlamps.

Level	Login	Password	Description
Integrator	4	Confidential	<i>Third-party company</i> responsible for the integration of the Luminoscope® in a production or audit line.
<i>LET Service Engineer</i>	5	Confidential	LET Service Engineer.

**Note:**

This password is hard-coded and cannot be changed.

The following screen appears when either wrong or no credentials at all are introduced. In this case the **Setup** screen will be automatically displayed with very limited access rights.

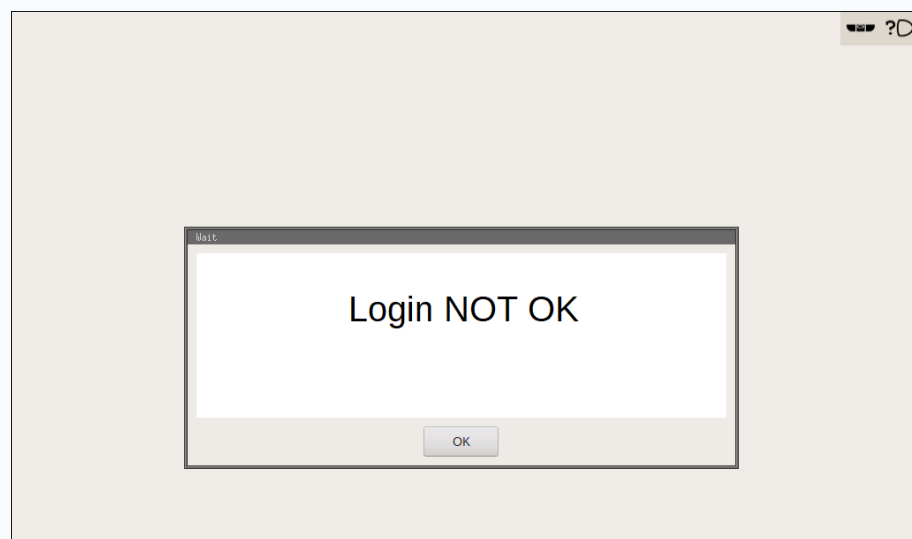

Figure 186: **Login not OK** screen

4. Choose one of the options on the **Setup** screen and tap on the corresponding button.

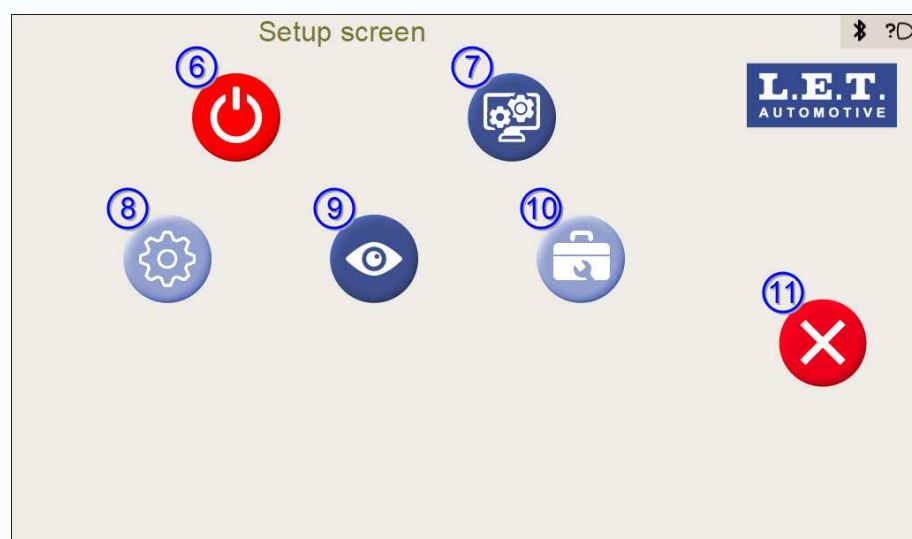

Figure 187: **Setup** screen



**Note:** The **Setup** screen, **Computer configuration** screen, **Settings program** screen, **Verification** screen and **Calibration** screen may have different appearances depending on the customer's specific implementation and the applied login level.

As a consequence, some of the functions in the table below may not be accessible.

#	Button	Description
6	<b>Power</b> button	Turn off or restart the Luminoscope®.
7	<b>Computer configuration</b> button	Amongst others, the <b>Computer configuration</b> screen gives access to the following functions: <ul style="list-style-type: none"> <li>• Date and time setup</li> <li>• <i>WiFi</i> setup</li> <li>• <i>Ethernet</i> setup<sup>1</sup></li> <li>• <i>Bluetooth</i> setup<sup>1</sup></li> <li>• Check for and apply available firmware updates</li> <li>• Log file information</li> <li>• Licensing information</li> </ul>
8	<b>Settings program</b> button	The settings program (system database) provides access to the following items: <ul style="list-style-type: none"> <li>• Vehicle parameters (programs)</li> <li>• Headlamp parameters (tests)</li> <li>• Component parameters</li> <li>• User parameters</li> </ul>
9	<b>Verification</b> button	Among others, the <b>Verification</b> screen gives access to the following functions: <ul style="list-style-type: none"> <li>• <i>Zero reference</i> verification</li> <li>• <i>Intensity</i> verification</li> <li>• <i>I/O</i> diagnostics: parallel, serial and <i>Bluetooth</i></li> <li>• <i>System information</i></li> <li>• <i>Position Check</i> verification</li> <li>• <i>ESL</i> (Electronic Spirit Level) module verification</li> <li>• <i>Light modulation</i> verification</li> <li>• <i>Electronic height measurement</i> verification</li> <li>• Battery verification</li> </ul>
10	<b>Calibration</b> button	Among others, the <b>Calibration</b> screen gives access to the following functions: <ul style="list-style-type: none"> <li>• Direct camera connection</li> <li>• <i>Zero reference</i> calibration</li> <li>• <i>Position Check</i> calibration</li> <li>• <i>ESL</i> (Electronic Spirit Level) module calibration</li> <li>• <i>Electronic height measurement</i> calibration</li> <li>• Battery calibration</li> </ul>

<sup>1</sup> Function availability is optional and depends on the supply of additional hardware.

#	Button	Description
11	<b>Abort</b> button	Return to the <b>Program selection</b> screen.

**Related tasks**

[Computer configuration](#) screen (pg. 221)

**Related information**

[Power management](#) (pg. 55)



---

# 11 Computer configuration screen

---

The **Computer configuration** screen acts as a hub for a number of functions. Among others, it gives access to the following functions, which are thoroughly described in the upcoming chapters:

- Date and time setup.
- Network connection setup: *WiFi* and (optional) *Ethernet*.
- Check for and apply available firmware updates.
- Log file information.
- Delete log and result files.
- Licensing information.

The **Computer configuration** screen is reached via a button on the **Setup** screen. If needed, please check relevant link at the end of this chapter.

Starting from the **Setup** screen.

1. Tap on the **Computer configuration** button 1 of the **Setup** screen.

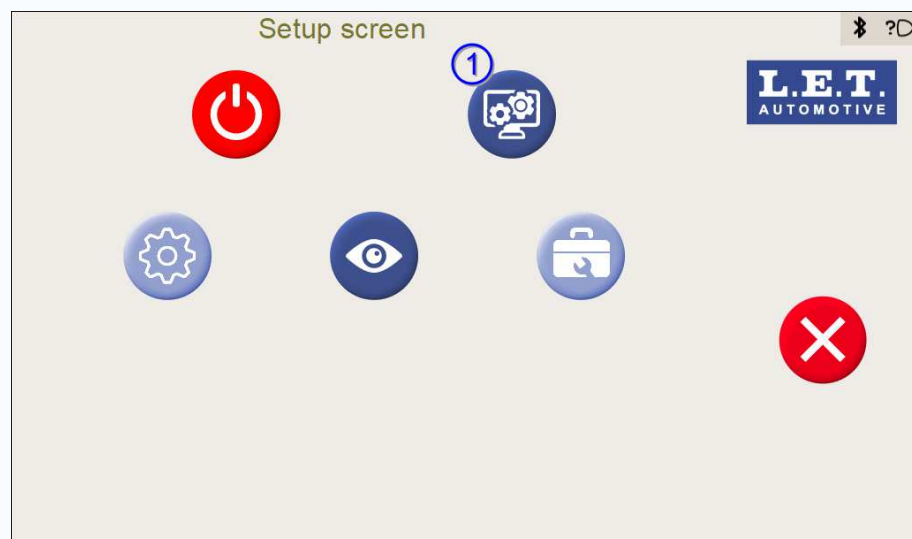

Figure 188: **Setup** screen with **Computer configuration** button

The **Computer configuration** screen is now displayed.

2. Choose one of the options of the **Computer configuration** screen and tap on the corresponding button.

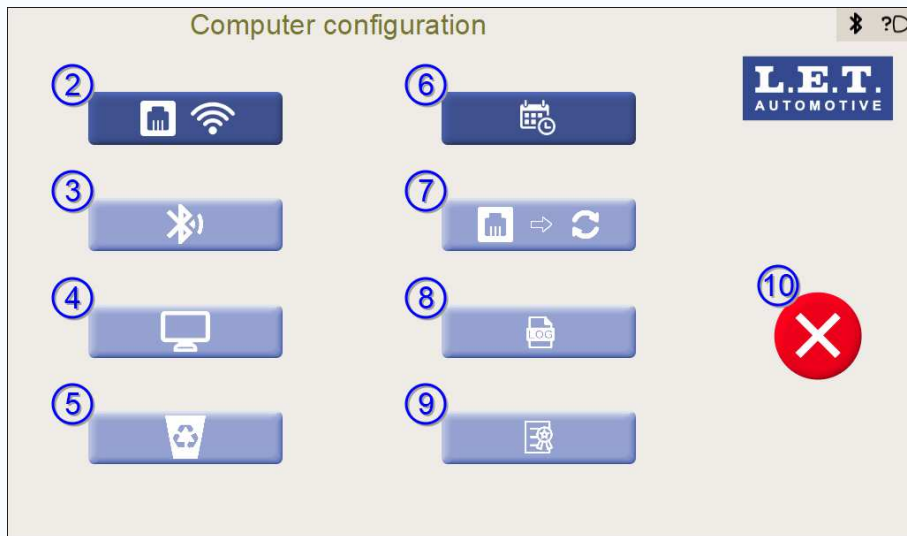

Figure 189: **Computer configuration** screen

**Note:** The screen may have a different appearance depending on the customer's specific implementation and the applied access level.

#	Button	Description
2	<b>Network interfaces settings</b> button <sup>2</sup>	WiFi and Ethernet connections setup.
3	<b>Bluetooth</b> button <sup>1</sup>	Bluetooth connection setup.
4	<b>External HDMI monitor</b> button <sup>1</sup>	External HDMI monitor setup.
5	<b>Delete logs and results</b> button <sup>2</sup>	Delete log and result files from the Luminoscope®.
6	<b>Date and time</b> button	Date and time setup.
7	<b>Online firmware update</b> button	Check for and apply available firmware updates.
8	<b>View log</b> button	Check log files.
9	<b>Licensing information</b> button <sup>2</sup>	Check software licensing info.
10	<b>Abort</b> button <sup>2</sup>	Return to the <b>Setup</b> screen.

<sup>1</sup> Function not available for the SLA 40.

<sup>2</sup> Functionality depends on the installed options.

**Related tasks**[Setup screen](#) (pg. 215)

## 11.1 Date and time setup

The **Date and time** button on the **Computer configuration** screen gives access to the menu to configure the date and time settings of the Luminoscope®.

Date and time settings can be achieved either manually or via an automatic synchronization over the network.

Starting from the **Computer configuration** screen.

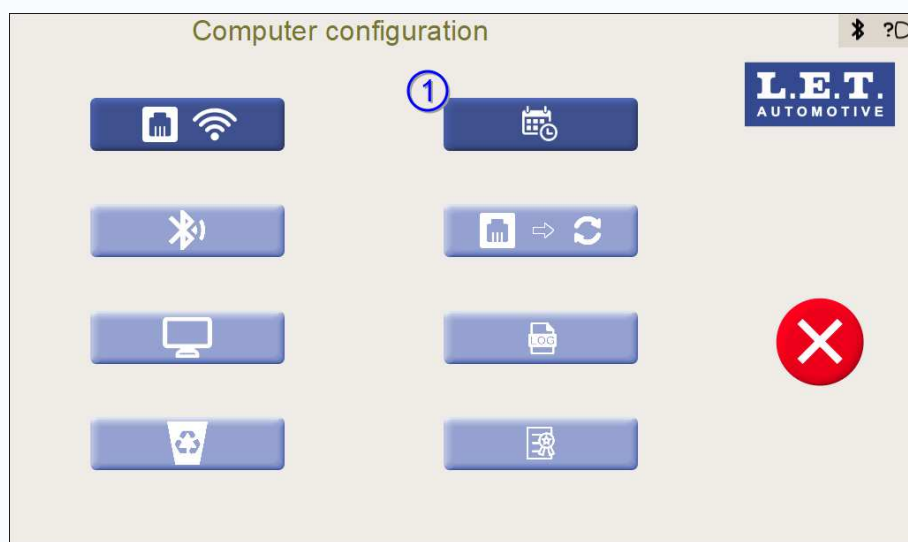

Figure 190: **Computer configuration** screen with **Date and time** button

1. Tap on the **Date and time** button 1 on the **Computer configuration** screen.  
The **Time zone settings** screen is now displayed.

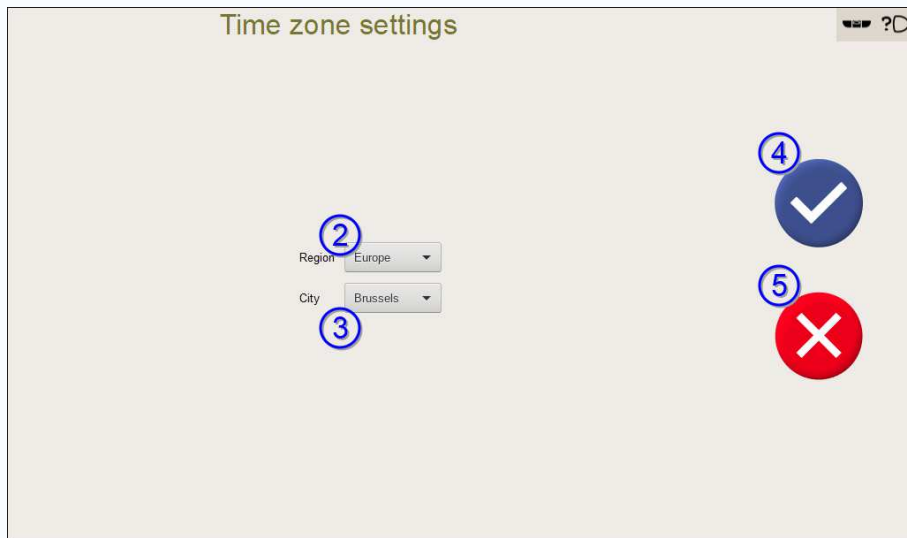

Figure 191: Time zone settings

2. Select the correct time zone region 2 and the nearest city 3 out from the list.
3. Tap on the **Save** button 4 to save the settings. Alternatively tap on the **Abort** button 5 to return to the **Computer configuration** screen.

### 11.1.1 Manual date and time setting

The Luminoscope® date and time can be set manually.

Start from the **Date and time setup** screen.

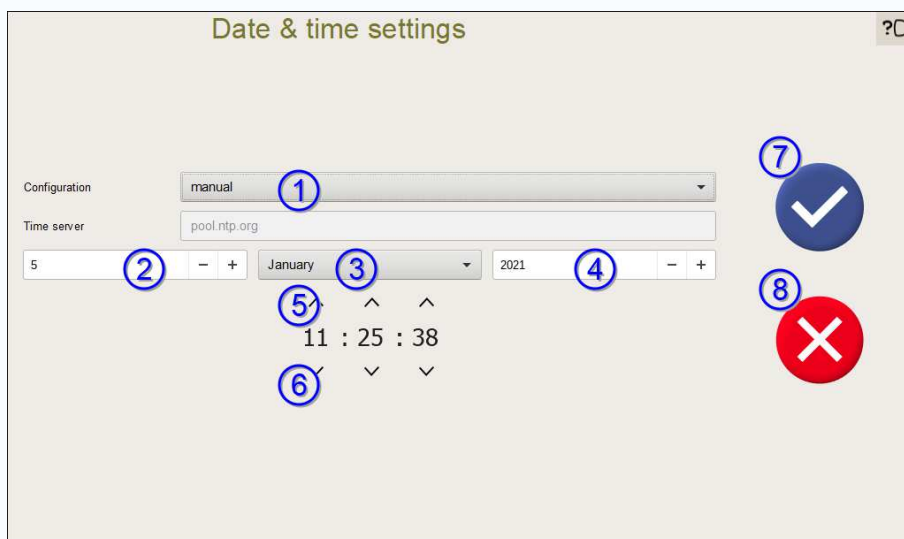

Figure 192: Manual date and time setup

1. Select **Manual** option from the **Configuration** menu 1.

2. Set the correct day 2, month 3 and year 4.
3. Set hour, minutes and seconds by using the corresponding up 5 and down 6 arrows.
4. Tap on the **Save** button 7 to save the settings. Alternatively tap on the **Abort** button 8 to return to the **Computer configuration** screen.

### 11.1.2 Automatic date and time setup

The Luminoscope® date and time can be set to automatically synchronize over the network.



**Attention:** The Luminoscope® must be connected to a network providing access to the *NTP* server which is to be used. Additionally, it also needs connectivity for a *DNS* server. Make sure the following ports of the selected servers are reachable:

- *NTP* server, port *UDPI*/123.
- *DNS* server, port *UDPI*/53 and port *TCP*/53.

Start from the **Date and time setup** screen.

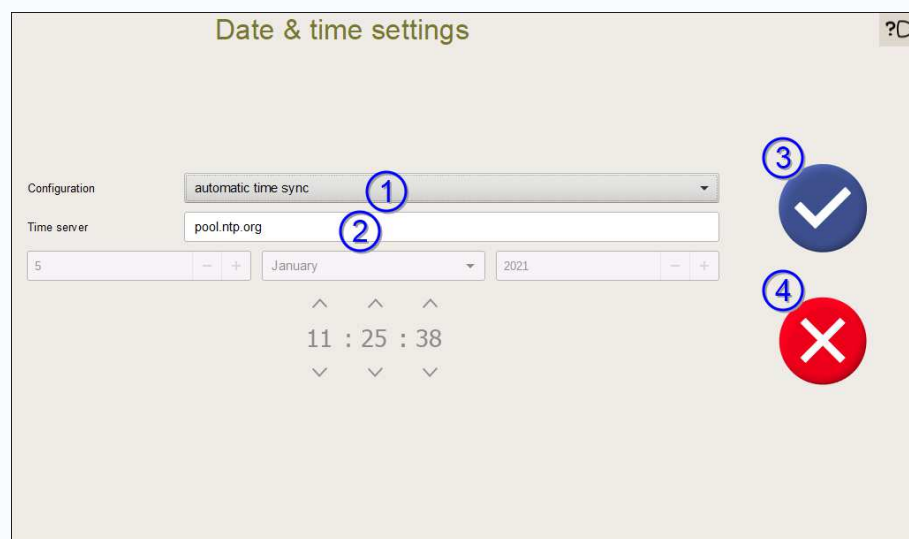

Figure 193: Automatic date and time setup

1. Select **Automatic time sync** from the **Configuration** menu 1.



**Note:** The **Date and time settings** controls can no longer be changed manually.

2. Enter the name or address of the time server 2 (e.g. *pool.ntp.org*).
3. Tap on the **Save** button 3 to save the settings. Alternatively tap on the **Abort** button 4 to return to the **Computer configuration** screen.

## 11.2 WiFi networking

The **Network interfaces settings** button on the **Computer configuration** screen gives access to the **Network interfaces selection** screen, that allows the operator to select which network interface to be configured.

Either *WiFi* or *Ethernet* (optional) external interfaces can be selected. In both cases, they are connected to the external *USB* hub.

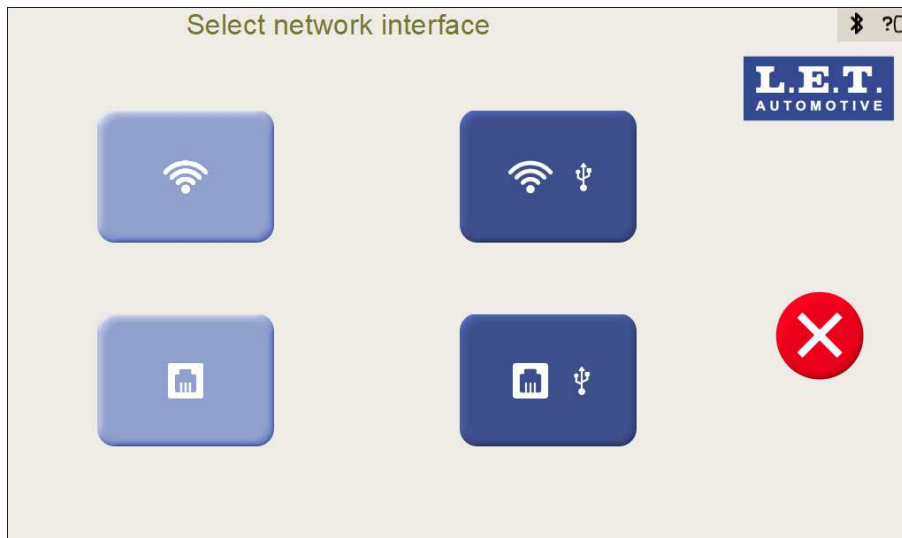

Figure 194: **Network interfaces selection** screen



**Attention:** Do not enable more than one network interface at a time. The Luminoscope® doesn't support using more than one simultaneous network interface. Make sure all other interfaces are disabled before enabling a new one.

The Luminoscope® *WiFi* networking can operate in two different modes:

- **AP mode**, on which the Luminoscope® acts as a *WiFi* local access point (*AP*). This mode doesn't provide any additional routing to other networks and is limited to the access to the Luminoscope® provided services. It is very convenient when there is no available *WiFi* infrastructure on the site.
- **Regular mode**, connecting the Luminoscope® to an available *WiFi* network via either *Dynamic Host Configuration Protocol (DHCP)* or specifying a static connection networking set of parameters.

Starting from the **Computer configuration** screen.

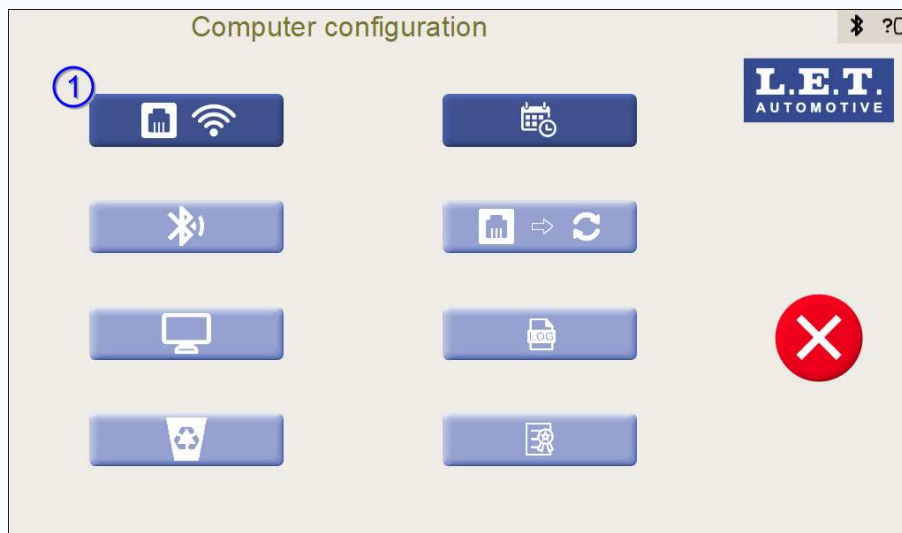

Figure 195: **Computer configuration** screen with **Network interfaces settings** button

1. Tap on the **Network interfaces settings** button 1 on the **Computer configuration** screen. The **Network interfaces selection** screen is now displayed.

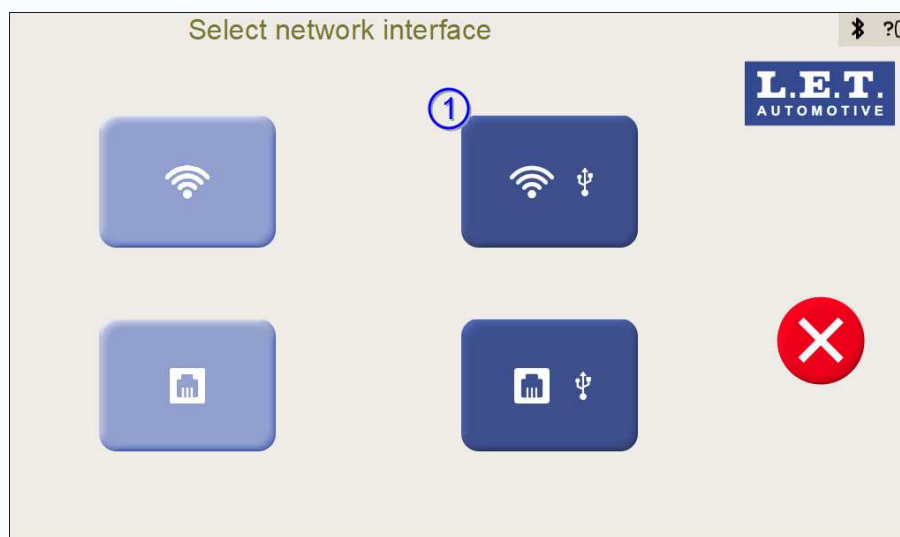

Figure 196: **Network interfaces selection** screen

2. Tap on the **External WiFi** button 1 to select the interface to be configured. The **WiFi settings** screen is now displayed and the **General info** tab is active.



Figure 197: **WiFi settings** screen with general info

**Note:** The screen may have a different appearance depending on the earlier applied *WiFi* settings.

**Note:** The QR codes are not displayed by default. This is controlled via the web interface followed by a system reboot.

#	Name	Description
2	<b>WiFi ON / OFF</b> switch	Enables or disables <i>WiFi</i> communication.
3	<b>Connection status</b> indication	Shows if the wireless connection is currently established and usable.
4	<b>AP mode</b> switch	Controls the <i>WiFi</i> networking working mode of the Luminoscope®, switching between <i>AP mode</i> and <i>Regular mode</i> .
5	<b>WiFi autoconnect</b> switch	Enables or disables automatic connection to the last <i>WiFi</i> network.
6	<b>General info</b> tab	Provides access to the General information on the <i>WiFi</i> communication: <ul style="list-style-type: none"> <li>• MAC address of the physical interface</li> <li>• IP address of the Luminoscope®</li> <li>• Network Mask</li> <li>• RX bytes (number of received bytes)</li> <li>• TX bytes (number of transmitted bytes)</li> <li>• SSID (Service Set Identifier)</li> <li>• Signal strength</li> </ul>

#	Name	Description
7	<b>Networking setup</b> tab	Provides access to the Network setup for the <i>WiFi</i> configuration. <ul style="list-style-type: none"> <li>DHCP (Dynamic Host Configuration Protocol) ON/OFF switch.</li> </ul> In case <i>DHCP</i> is not selected: <ul style="list-style-type: none"> <li>IP address</li> <li>Netmask</li> <li>Gateway</li> <li>DNS server</li> </ul>
8	<b>Network list</b> tab	Provides access to a list of available <i>WiFi</i> networks including the signal strength and the <i>WiFi</i> protection type. It allows the operator to select the network to connect to.
9	<b>Save setup</b> button	Saves the current setup for being used upon a restart.
10	Internal AP credentials	Optionally displayed QR-code that, when read with a modern smartphone, provides easy input of the internal AP credentials. The text under the QR-code provides the same information in a human-readable form.
11	Access URL for the Luminoscope® web interface	Optionally displayed QR-code that, when read with a modern smartphone, provides easy access to the Luminoscope® web interface. The text under the QR-code provides the same information in a human-readable form.
12	<b>Abort</b> button	Returns to the <b>Computer configuration</b> screen.

### Related tasks

[Check and/or modify some settings of the Luminoscope](#) (pg. 248)

### 11.2.1 *WiFi* applications

The applications of the *WiFi* connection are among others:

- Remotely operating the Luminoscope®. This is achieved via the VNC-protocol access to the Luminoscope®. Both **AP mode** and **Regular mode** provide support for this application.
- Remotely accessing the configuration of the Luminoscope®, providing the eventual maintenance or technical staff with the possibility of completing their task from a suitable or adequate workplace. This is achieved via the VNC-protocol access to the Luminoscope®. Both **AP mode** and **Regular mode** provide support for this application.

However, operations such *Remote Upload* or *Check for Updates* over network, for which the Luminoscope® needs internet access, cannot be completed unless the **Regular mode** is active.

- Integration of the Luminoscope® into an upper level network for sharing the inspection reports outcome data with a higher level system as technical registers, factories' SCADAs (*Supervisory Control and Data Acquisition*), databases and so on. The nature of these

networking applications is better achieved with the **Regular mode** which purpose is more focused on a permanent connection.

- Remotely accessing the Web Interface of the Luminoscope®.

In all cases, any multimedia device (desktop, laptop, tablet, smartphone, etc.) can be used as the client for these activities.

Requirements are:

- Proper *WiFi* connectivity
- VNC protocol client available

The upcoming chapters explain how the Luminoscope® can be switched between the described modes and how to manage the connection of the Luminoscope® to an available *WiFi* network.

### 11.2.2 Local Access Point setup

The Luminoscope® can be configured to act as a *WiFi* local access point (*AP mode* for short).

Starting from the **WiFi settings** screen.

1. Enable the *AP* mode by setting the **AP mode** switch 4 to its **ON** position.  
The Luminoscope® creates a *WiFi* hotspot with the name `LuminoscopeAP`.
2. Tap on the **Save setup** button 9 to save the current settings and use them upon restart.
3. Connect a *WiFi* equipped laptop to the hotspot `LuminoscopeAP`.  
Use the password `Luminoscope00` (with two trailing zeros) for that purpose.
4. Configure the Luminoscope® as required.  
Remotely complete the configuration of the different settings with the convenience and flexibility of the *WiFi* network range.
5. Once finished, disable the *AP* mode by setting the **AP mode** switch 4 to its **OFF** position.
6. Tap on the **Save setup** button 9 to save the current settings and use them upon restart.

### 11.2.3 Regular mode setup

The Luminoscope® can be connected to an available *WiFi* network via either *Dynamic Host Configuration Protocol (DHCP)* or specifying a static connection networking parameter set.



**Attention:** Do not enable more than one network interface at a time. The Luminoscope® doesn't support using more than one simultaneous network interface. Make sure all other interfaces are disabled before enabling a new one.

Starting from the **WiFi settings** screen.

#### Enable/disable the *WiFi* communications:

1. Set the *WiFi* **ON / OFF** switch 2 to the **ON** position to enable the *WiFi* communications. Alternatively, set the switch to **OFF** to disable them.
2. Tap on the **Network list** tab 8.  
The **WiFi networks List** screen is now displayed.



Figure 198: *WiFi networks List* screen without available networks

3. Tap on the **Refresh** button 11 to show all available *WiFi* SSIDs (wireless network names) or to refresh the network list.  
The following screen is displayed:

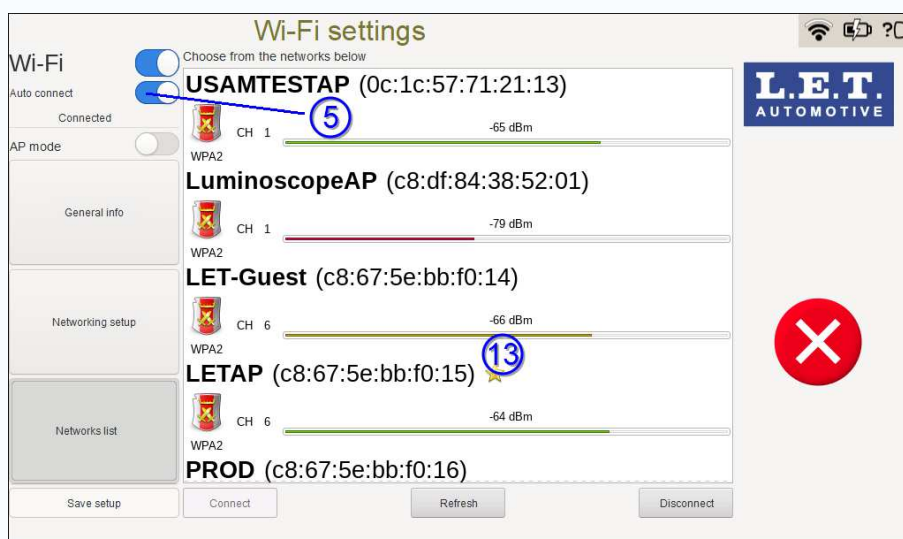

Figure 199: *WiFi networks List* screen with available WiFi networks



**Note:** The network list may have a different appearance and content depending on the available *WiFi* networks and the customer's specific implementation.

A yellow star icon 13 signals the *WiFi* network *SSID* to which the Luminoscope® is connected if so. Otherwise, there is no star icon associated to any network.

4. Activate the **WiFi autoconnect** switch 5 in order to automatically connect to the last *WiFi* network.

**If it is needed to connect to another *SSID*:**

5. Delete the current *WiFi* connection setup initially by tapping on the **Disconnect** button 12 if already established.
6. Select the preferred *SSID* by tapping on it.  
The selected network is highlighted.



**Attention:**

- Use the *SSID* with the strongest signal for which you have proper credentials.
- A stable and dependable *WiFi* link will require a signal level stronger than -75dBm.
- *WPA2* protection is mandatory.

7. Tap on the **Connect** button 10 to connect to the selected *SSID*.  
The following screen is displayed:

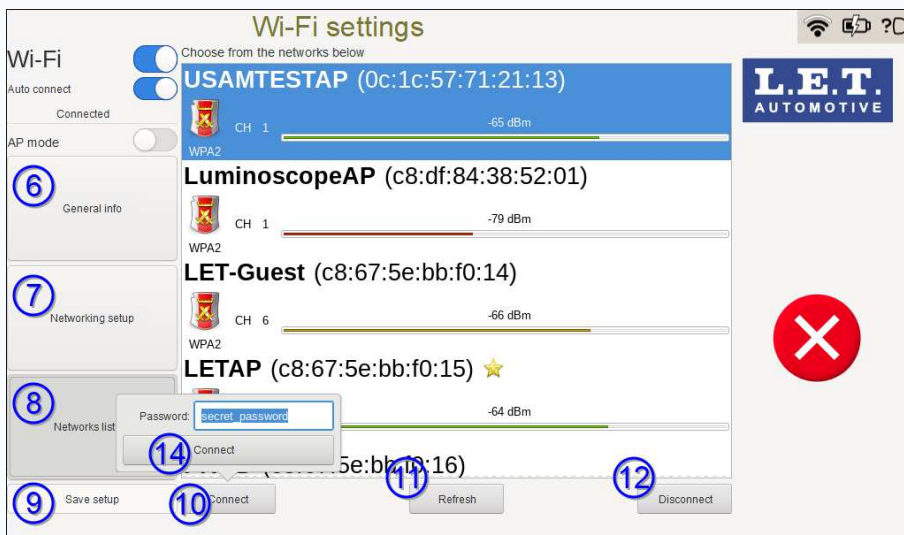

Figure 200: **WiFi networks List** screen with password entry

8. Enter the *WiFi* network password and tap on the **Connect** button 14 on the pop-up screen.
9. Tap on the **Save setup** button 9 to save the current settings and use them upon restart.
10. Tap on the **Refresh** button 11 to update the network list.



**Note:** The chosen network *SSID* is marked with a yellow star icon.

**Recalling the data corresponding with the current connection:**

**11.** Tap on the **General info** tab 6 to consult the info about the *WiFi* communication.

- **MAC address**
- **IP address**
- **Netmask**
- **RX bytes** (Received bytes)
- **TX bytes** (Transmitted bytes)
- **SSID** (Service Set Identifier i.e. wireless network name)
- Signal **Strength**

The following screen is displayed:



Figure 201: *WiFi settings* screen with *General Info*

**Accessing for modifying or querying the network details of the *WiFi* connection:**

**12.** Tap on the **Networking setup** tab 7 to modify the *WiFi* info.

The following screen is displayed:



Figure 202: WiFi networks List screen with network configuration

The networking parameters can be set manually or automatically via *DHCP*.

#### Obtaining network parameters automatically via *DHCP*:

13. Set the ***DHCP*** switch 15 to **ON** to let the Luminoscope® adjust the network parameters without manual intervention.  
The Luminoscope® dialogs with the *DHCP* server to obtain the applicable set of networking parameters and they are updated on the display fields.
14. Tap on the **Apply** button 16 to apply the new values to the current connection.
15. Tap on the **Save setup** button 9 to save the current settings and use them upon restart.

#### Setting the network parameters manually:

16. Set the ***DHCP*** switch 15 to **OFF** to manually enter the networking parameters.  
Depending on the specific network setup, it may be interesting to set manually the network parameters.
17. Set the correct network values.  
Carefully enter the proper valid values for:
  - **IP address**
  - **Netmask**
  - **Gateway**
  - **DNS**
18. Tap on the **Apply** button 16 to apply the new values to the current connection.
19. Tap on the **Save setup** button 9 to save the current settings and use them upon restart.

### 11.3 Ethernet networking

The **Ethernet** button on the **Computer configuration** screen gives access to the configuration of the *Ethernet* network operations and settings of the network operations of the Luminoscope®.

The **Network interfaces settings** button on the **Computer configuration** screen gives access to the **Network interfaces selection** screen, which allows the operator to specify the network interface to be configured.

Either *WiFi* or *Ethernet* interfaces configuration can be selected here.

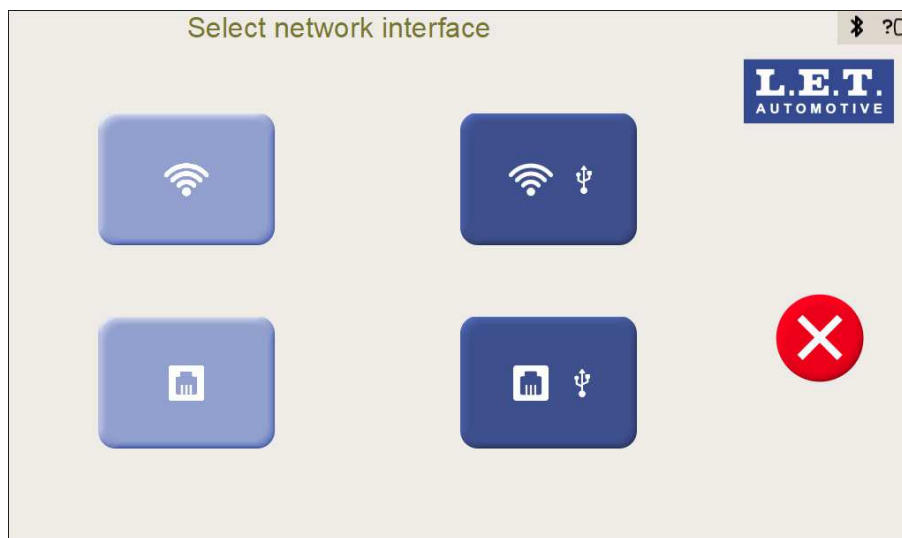

Figure 203: **Network interfaces selection** screen



**Attention:** Do not enable more than one network interface at a time. The Luminoscope® doesn't support using more than one simultaneous network interface. Make sure all other interfaces are disabled before enabling a new one.

Starting from the **Computer configuration** screen.

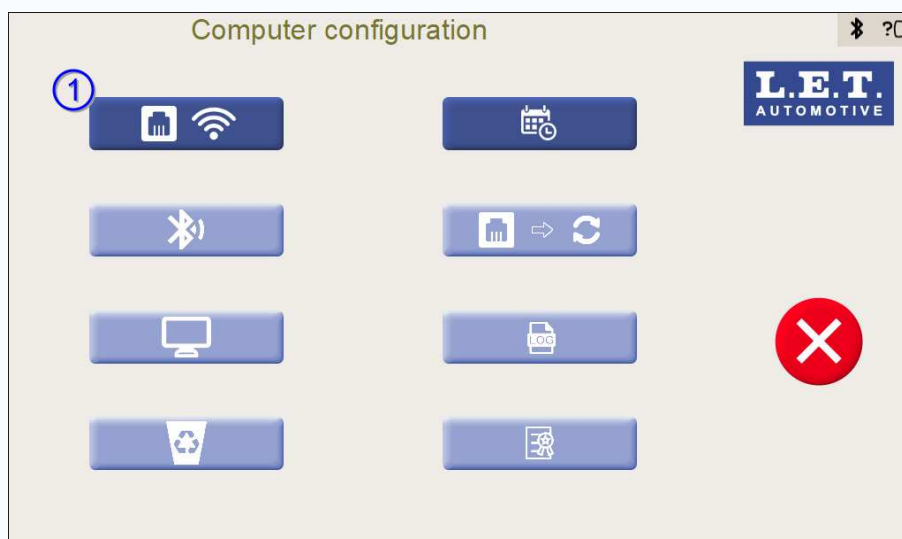

Figure 204: **WiFi settings** screen with General Info

1. Tap on the **Network interfaces settings** button 1 on the **Computer configuration** screen.

The **Network interfaces selection** screen is now displayed:

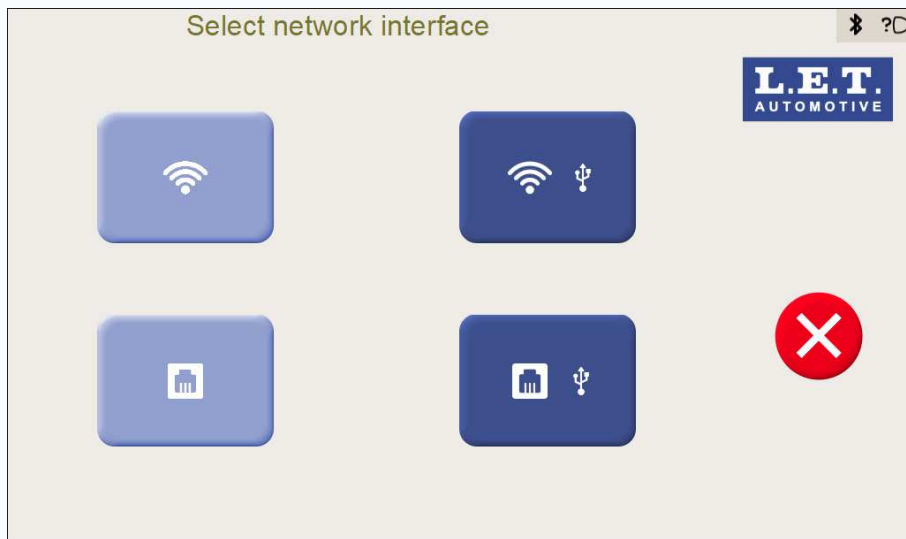

Figure 205: **Network interfaces selection** screen

2. Tap on any of the **Internal Ethernet** button 1 or the **External Ethernet** button 2 to select the interface to be configured.

**Note:** The internal interface refers to the built-in, optional *WiFi* interface, while the external interface refers to the also optional *WiFi* dongle interface, connected to the *USB* port. Both require identical settings and operations, and the only visible difference is an indication of the interface type on the screen titles.

The **Ethernet settings** screen is now displayed and the **General info** tab is active.

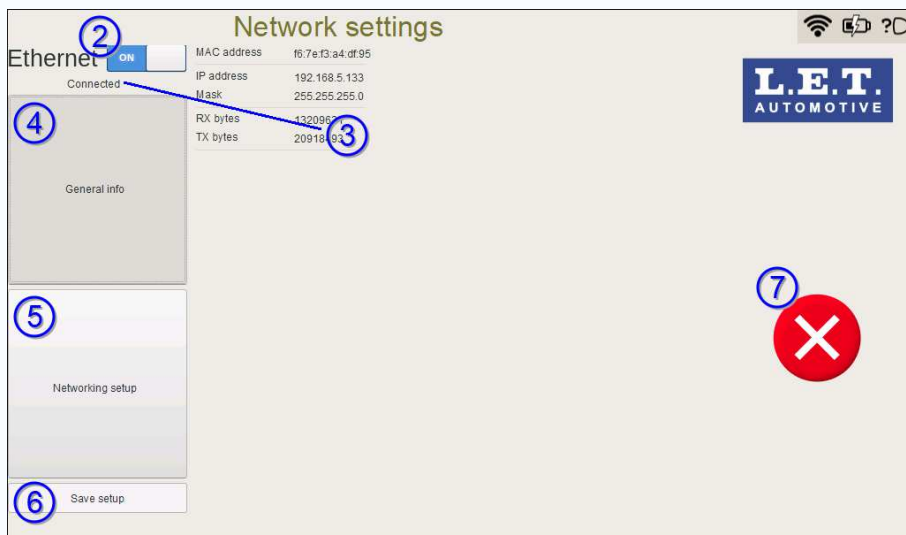

Figure 206: **Ethernet settings** screen with general info

**Note:** The screen may have a different appearance depending on the earlier applied *Ethernet* settings.

#	Name	Description
2	<b>Ethernet ON / OFF</b> switch	Enables or disables the <i>Ethernet</i> communication.
3	<b>Connection</b> status indicator	Shows if the <i>Ethernet</i> wired connection is currently established and usable.
4	<b>General info</b> tab	Provides access to the General information on the <i>Ethernet</i> communication configuration: <ul style="list-style-type: none"> <li>• MAC address of the physical interface</li> <li>• IP address of the Luminoscope®</li> <li>• Network Mask</li> <li>• RX bytes (number of received bytes)</li> <li>• TX bytes (number of transmitted bytes)</li> </ul>
5	<b>Networking setup</b> tab	Provides access to the Network setup for the <i>Ethernet</i> configuration. <ul style="list-style-type: none"> <li>• DHCP (Dynamic Host Configuration Protocol) ON/OFF switch.</li> </ul> In case <i>DHCP</i> is not selected: <ul style="list-style-type: none"> <li>• IP address</li> <li>• Netmask</li> <li>• Gateway</li> <li>• DNS server</li> </ul>
6	<b>Save setup</b> button	Saves the current setup for being used upon restart.
7	<b>Abort</b> button	Returns to the <b>Computer configuration</b> screen.

### 11.3.1 *Ethernet* applications

The applications of the *Ethernet* connection are among others:

- Remotely operating the Luminoscope®. This is achieved via the VNC-protocol access to the Luminoscope®.
- Integration of the Luminoscope® into an upper level network for sharing the inspection reports outcome data with a higher level system as technical registers, factories' SCADAs (*Supervisory Control and Data Acquisition*), databases and so on.
- Remotely accessing the Web Interface of the Luminoscope®.

In all cases, a desktop or a laptop computer can be used as the client for these activities.

Requirements are:

- Proper *Ethernet* connectivity
- VNC protocol client available

The upcoming chapter explains how to manage the connection of the Luminoscope® to an available *Ethernet* network.

### 11.3.2 Ethernet setup

The Luminoscope® can be connected to an available *Ethernet* network via either *Dynamic Host Configuration Protocol (DHCP)* or specifying a static connection networking parameter set.



**Attention:** Do not enable more than one network interface at a time. The Luminoscope® doesn't support using more than one simultaneous network interface. Make sure all other interfaces are disabled before enabling a new one.

Starting from the **Ethernet settings** screen.

#### Enable/disable the *Ethernet* communications:

1. Set the *Ethernet ON / OFF* switch 2 to the **ON** position to enable the *Ethernet* communications. Alternatively set the switch to **OFF** to disable them.

The **Connection** status indicator 3 reflects the changes on the network connection availability.

#### Recalling the data corresponding with the current connection:

2. Tap on the **General info** tab 4.

The following screen is displayed:

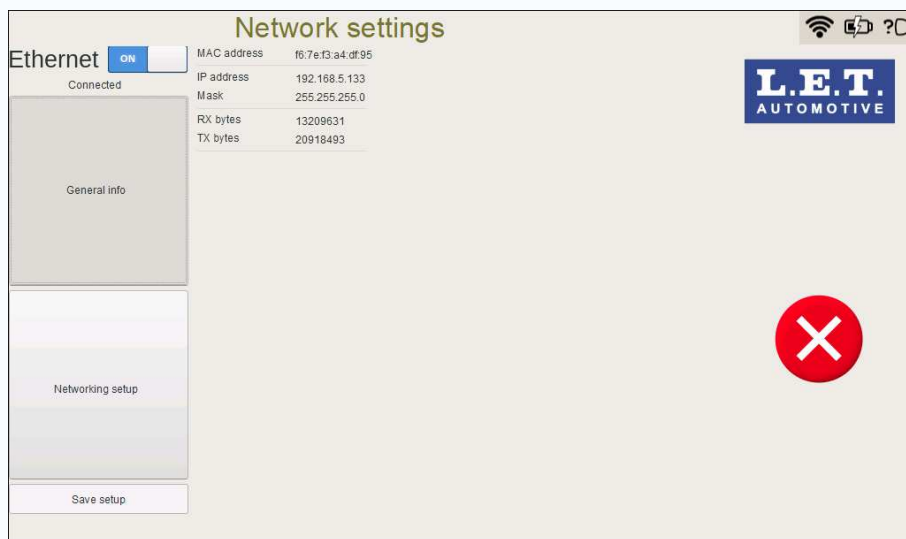

Figure 207: **Ethernet settings** screen with **General info** tab

The currently applied network parameters can be reviewed:

- **MAC address** of the physical interface
- **IP address** of the Luminoscope®
- **Network mask**
- **RX bytes** (Received bytes)
- **TX bytes** (Transmitted bytes)

#### Obtaining network parameters automatically via *DHCP*:

3. Tap on the **Networking setup** tab 5.

The following screen is displayed:

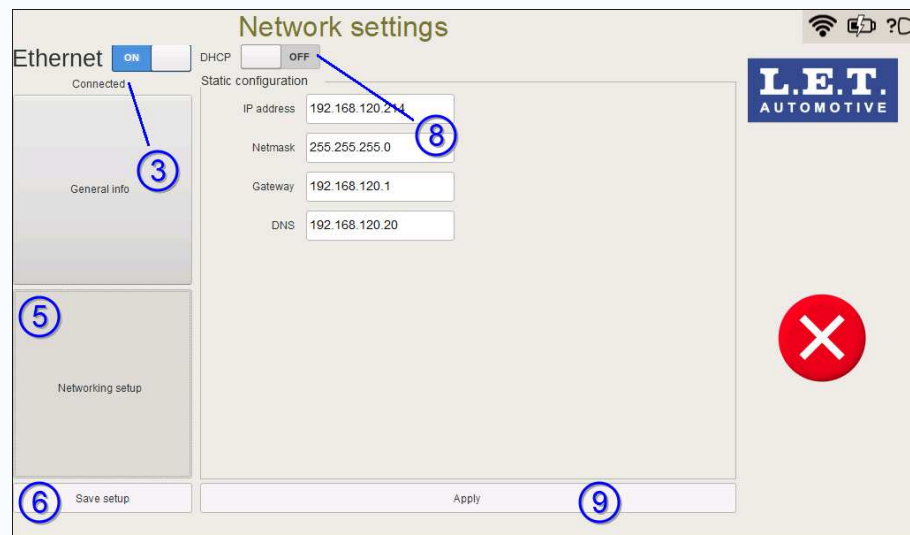

Figure 208: **Ethernet settings** screen with **Networking setup** tab activated changing **DHCP** status

4. Set the **DHCP** switch 8 to **ON** to let the Luminoscope® adjust the network parameters without manual intervention.

The Luminoscope® dialogs with the **DHCP** server to obtain the applicable set of network parameters so it can communicate efficiently with other network connected devices. **DHCP** also assigns the subnet mask, default gateway address, domain name server (**DNS**) address and other pertinent configuration parameters.

Of course, the network to which the Luminoscope® is connected must count with an appropriately configured **DHCP** server.

Once the IP address is assigned, the rest of inputs (IP address, Netmask, Gateway and DNS) are updated with the obtained values and disabled.

5. Tap on the **Apply** button 9 to apply the new values to the current connection.  
Once the values are correct and the network connection is established, the **Connection** status indicator 3 is updated.
6. Tap on the **Save setup** button 6 to save the current settings and use them upon restart.

#### Setting the network parameters manually:

7. Set the **DHCP** switch 8 to **OFF** to manually enter the network parameters.

The Luminoscope® requires a set of network parameters so it can communicate efficiently with other network connected devices.

8. Set the correct network values.  
Carefully enter the proper valid values for:

- **IP address**
- **Netmask**
- **Gateway**
- **DNS**

9. Tap on the **Apply** button 9 to apply the new values to the current connection.

Once the values are correct and the network connection is established, the **Connection** status indicator 3 is updated.

10. Tap on the **Save setup** button 6 to save the current settings and use them upon restart.

---

# 12 Web interface

---

This chapter explains how to operate the *web interface* of the Luminoscope® on a remote device (tablet, smartphone, laptop, desktop, ...). The remote device should have a *web browser* (e.g. Google Chrome, Firefox, ...) for accessing the *web interface*.

The *web interface* has many functions. Among others, it gives access to the following functions which are thoroughly explained in the upcoming chapters:

- Check the contact information of *LET Automotive*.
- Upload a logo on the *PDF* test reports.
- Check and/or print the *PDF* test reports and/or emails generation.
- Export the configuration file (backup file) of the Luminoscope®.
- Check or modify some settings in the Luminoscope®.
- Check the log files of the Luminoscope®.
- Check the stored camera images of the Luminoscope®.
- Check the stored screenshots of the Luminoscope®.
- Remotely operate the Luminoscope®.



**Note:**

- Both the Luminoscope® and the remote device should be properly connected to the same network (*LAN* or *WiFi*), allowing mutual IP access. At the end of the chapter there is a link with related information on how to connect the Luminoscope® to a *WiFi* network or *Ethernet* network.
- Some Luminoscope® optical blocks are provided with an optional *Ethernet* port on the connector plate. Consequently the *web interface* should be accessed over *WiFi* if the Luminoscope® has no *Ethernet* port.

The access to the options in the *web interface* is hierarchical and depends on the access rights of each login, which is identified with a password as follows:

Level	Login	Password	Description
Operator	1	1234	<i>Operator staff</i> working with the equipment.
Maintenance	2	Confidential	<i>Maintenance staff</i> and <i>production leaders</i> have access to most common functions except data related with vehicles and headlamps.
Process	3	Confidential	<i>Process staff</i> have additional access to data related to vehicles and headlamps.
Integrator	4	Confidential	<i>Third-party company</i> responsible for the integration of the Luminoscope® in a production or audit line.
<i>LET Service Engineer</i>	5	Confidential	LET Service Engineer.



**Note:**

This password is hard-coded and cannot be changed.

## 12.1 Access to the *web interface*

The following instructions explain how to access the *web interface* of the Luminoscope® either via the *LAN IP* address; *Wi-Fi IP* address or *host name* of the Luminoscope®. The *web interface* will appear in the *web browser* of a remote device.

1. Open the **System information** screen that is accessible via the **System** screen.

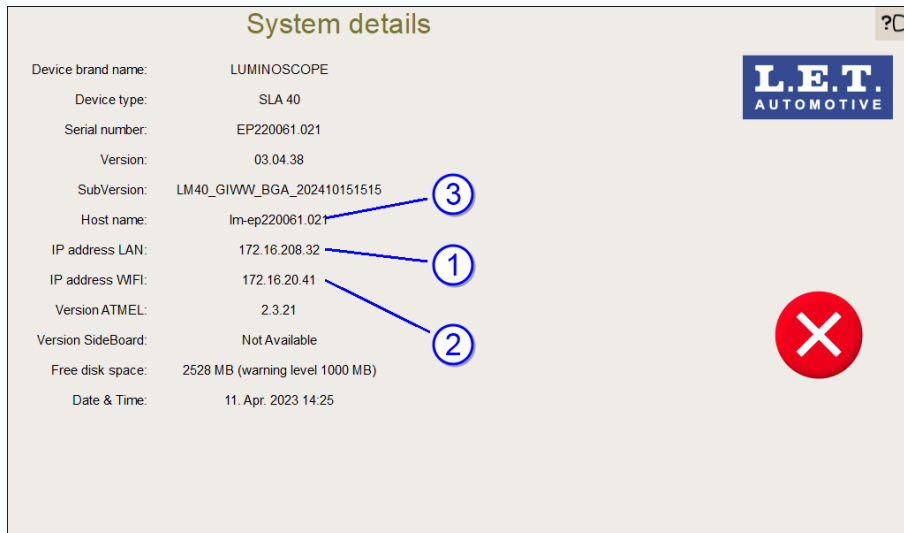

Figure 209: **System information** screen with system details for web connection

2. Locate the *LAN IP* address 1 (if applicable), the *Wi-Fi IP* address 2 or the *host name* 3.
3. Enter the corresponding address in any of these forms, in the navigation bar of a web browser of a remote device, prepended with the protocol scheme (`http://`).

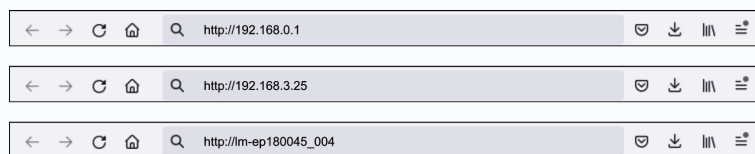

Figure 210: Browser navigation bar pointing to the *LAN IP* address, the *Wi-Fi IP* address and the *hostname* of the Luminoscope®, from top to bottom

4. Tap on the **Enter** button on the remote device.  
The **Web interface main** screen is now displayed:

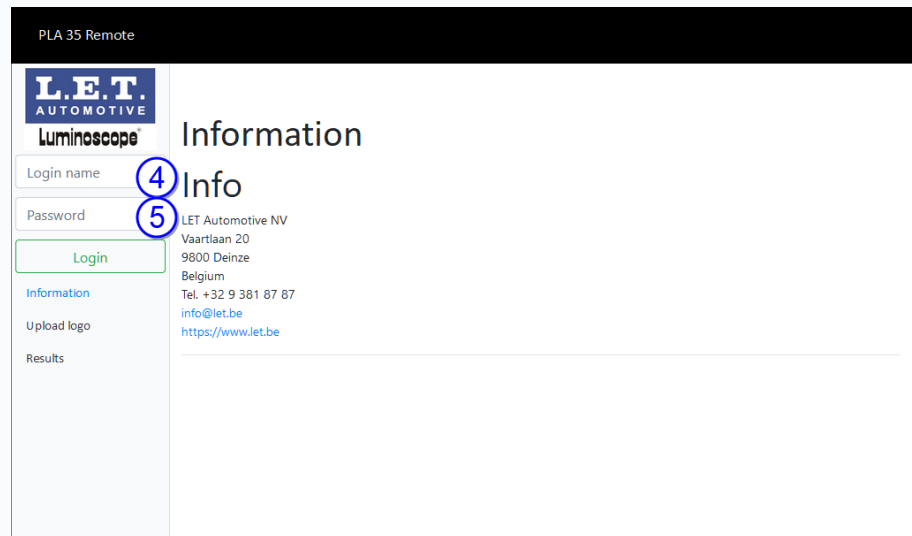

Figure 211: **Web interface main screen**



**Note:** It's recommended to create a shortcut in the web browser, for easily connecting to the Luminoscope® *web interface*.

5. Enter the login name 4 and password 5 in order to enable more functions of the *web interface*.

Use the table above to select the proper login and password for the corresponding access level.

The following screen is now displayed:

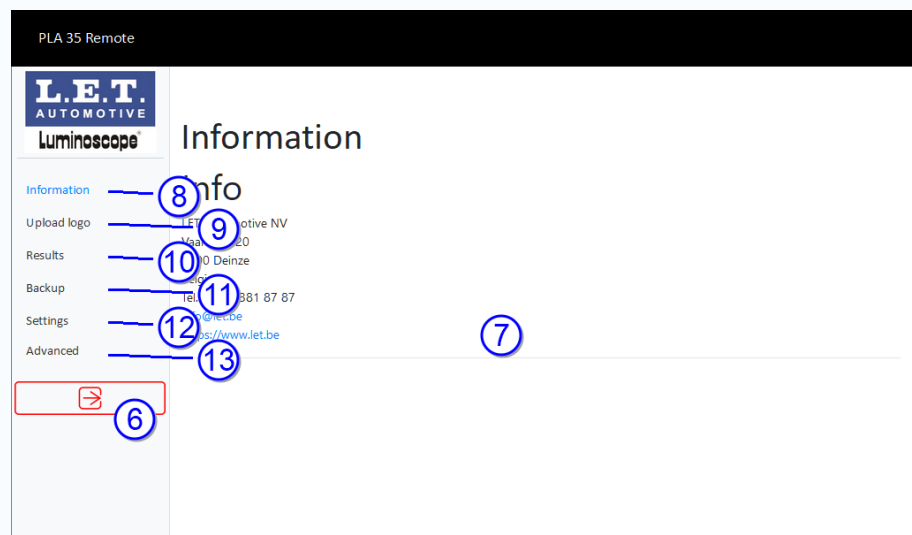

Figure 212: **Web interface main screen**

The following information fields, selection fields and buttons are available.

#	Element	Description
6	<b>Logout</b> button	Logout from the <i>web interface</i> .
7	<b>Information</b> field	LET Automotive contact information.

#	Element	Description
8	<b>Information</b> link	Displays <i>LET Automotive</i> contact information.
9	<b>Upload logo</b> link	Upload a logo (in <i>PNG</i> format) for the <i>PDF</i> test reports.
10	<b>Results</b> link	Check and/or print the <i>PDF</i> test reports.
11	<b>Backup</b> link	Export the configuration file (backup file) from the Luminoscope® to a remote device.
12	<b>Settings</b> link	Check and/or modify some settings of the Luminoscope®: Customer settings: Name, Address, Phone, E-mail.
13	<b>Advanced</b> link	Access the advanced settings of the Luminoscope®: <ul style="list-style-type: none"> <li>• Check the log files.</li> <li>• Check the stored camera images.</li> <li>• Check the stored screenshots.</li> <li>• Remote operation.</li> </ul>

The following chapters explain the different functionalities of the *web interface*.  
After logging in with the applicable password, the user has access to more functions of the *web interface*. From now on the session is called an *authorized session*.

## 12.2 Upload a customer logo for the *PDF* test reports

This chapter explains how to upload a logo (in *PNG* format) to be displayed, centered on top of the *PDF* test reports in the *web interface*.

Starting from the **Web interface main** screen in an authorized session.



**Note:** This functionality can also be achieved by a user which has not been logged in.

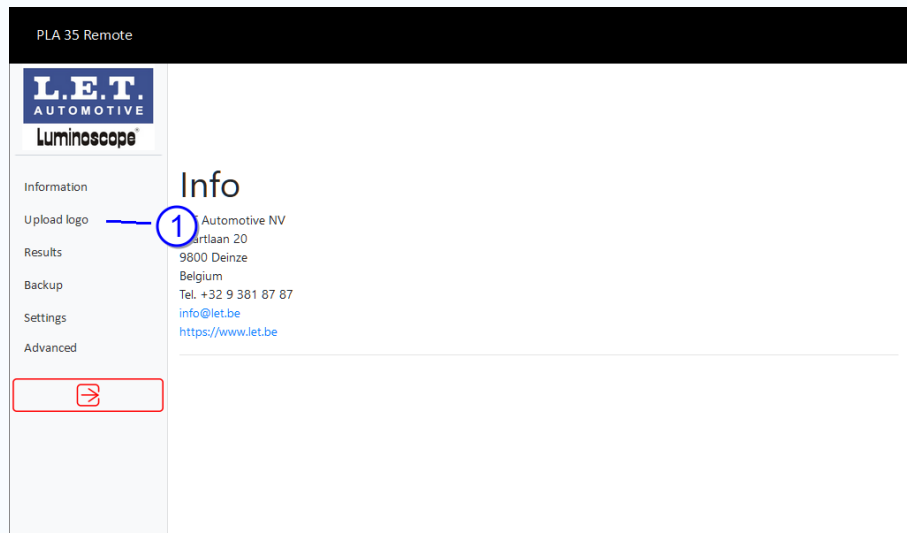

Figure 213: **Web interface main** screen in an authorized session

1. Click on the **Upload logo** link 1 on the **Web interface main** screen.

The following screen is now displayed:

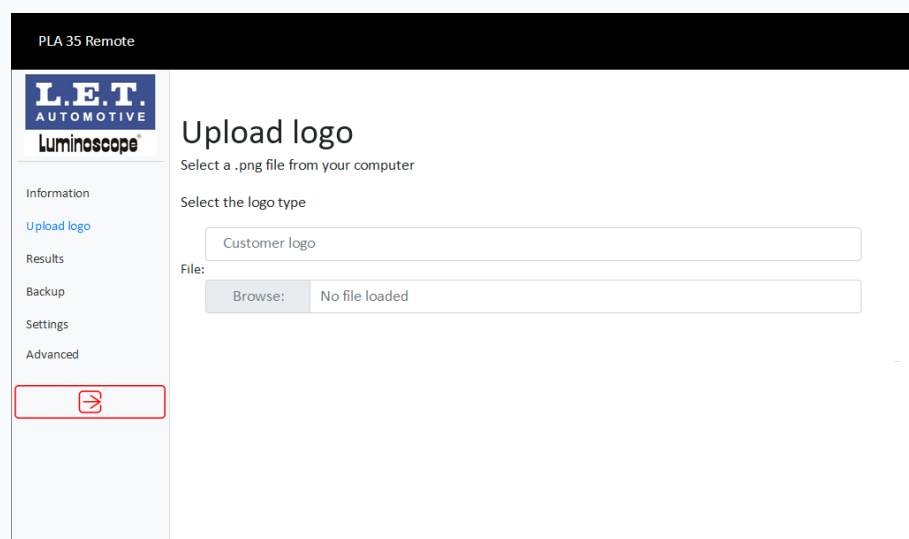

Figure 214: **Upload logo** screen

2. Browse to a customer logo (*PNG* format) and store the image to the Luminoscope®. The customer logo will now be shown centered on top of each *PDF* test report.

## 12.3 Check and/or print the *PDF* test reports

This chapter explains how to check and/or print the *PDF* test reports in the *web interface*.

Starting from the **Web interface main** screen in an authorized session.

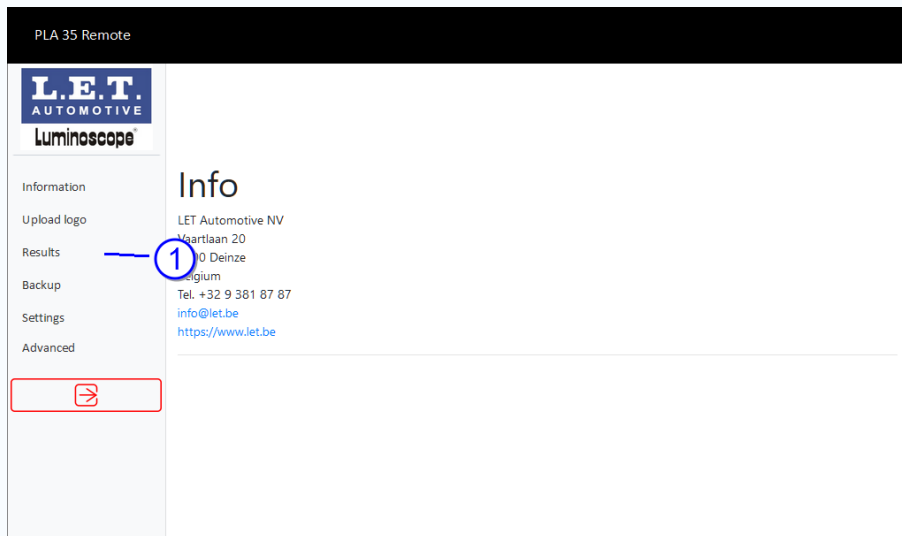

Figure 215: **Web interface main** screen in an authorized session

1. Click on the **Results** link 1 on the **Web interface main** screen.

The following screen is now displayed:

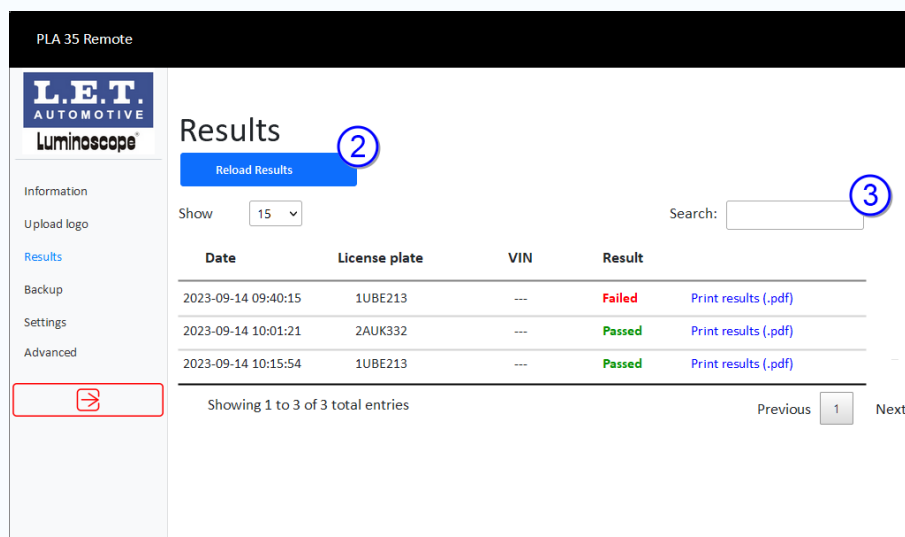

Figure 216: **Results** screen

The screen shows a list of all available test results. The test results can be split into different tab pages. Each entry shows the date and time, number plate (if applicable), VIN (vehicle identification number - if applicable) and the global result (passed or failed) of a test result.

2. Click on the **Print results** link 3 of a test result.

The *PDF* test report is now displayed in an extra tab page in the web browser. The *PDF* test report can be downloaded and then stored locally or printed on a local printer.

3. Tap on the **Reload results** button 2 for checking the availability of more test results. All available test results are now displayed.

## 12.4 Export the configuration file of the Luminoscope®

This chapter explains how to export a configuration file (backup file) from the Luminoscope® to a remote device via the *web interface*.

Starting from the **Web interface main** screen in an authorized session.

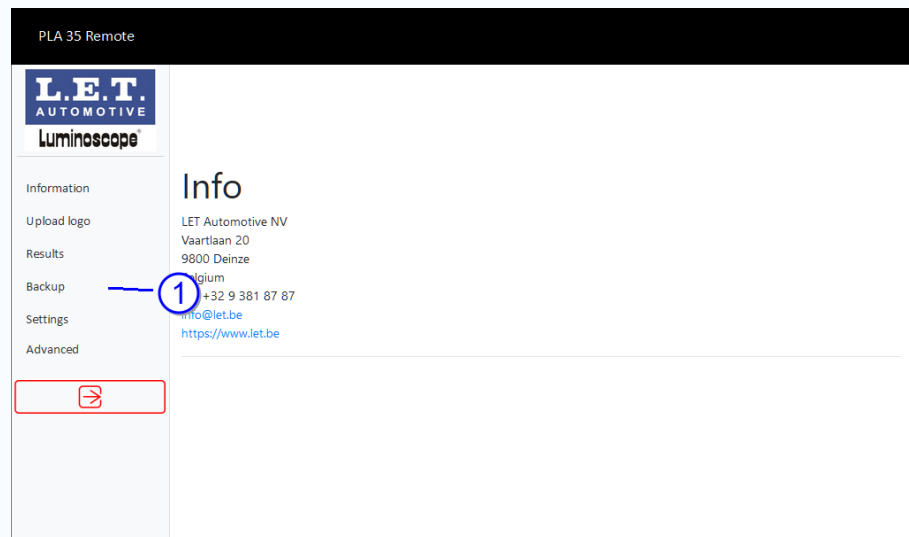

Figure 217: **Web interface main** screen in an authorized session

1. Click on the **Backup** link 1 on the **Web interface main** screen.

The following screen is now displayed:

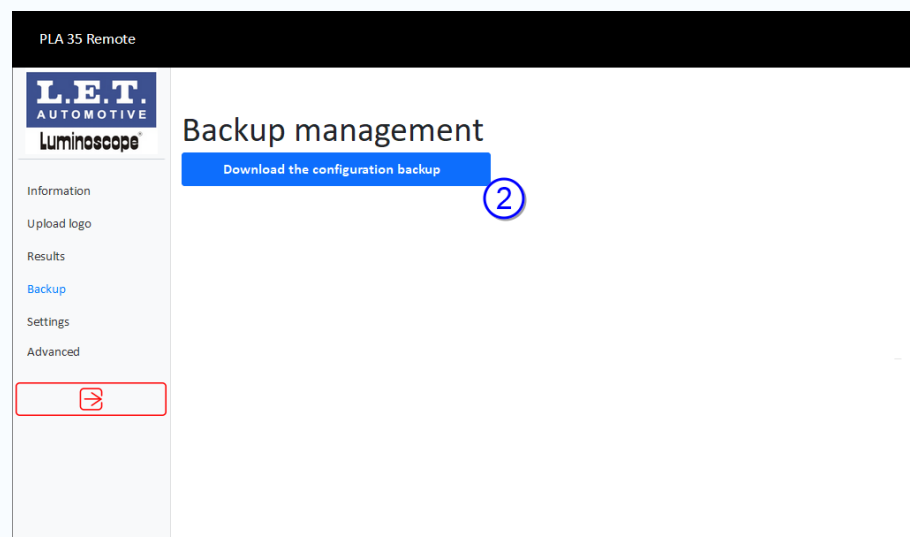

Figure 218: **Backup** screen

2. Tap on the **Download configuration backup** button 2 and choose a location for storing the configuration file of the Luminoscope® to the remote device.

The configuration file of the Luminoscope® has now been exported from the Luminoscope® and stored at the chosen location.

## 12.5 Check and/or modify some settings of the Luminoscope®

This chapter explains how to check and/or modify some settings of the Luminoscope®.

Starting from the **Web interface main** screen in an authorized session.

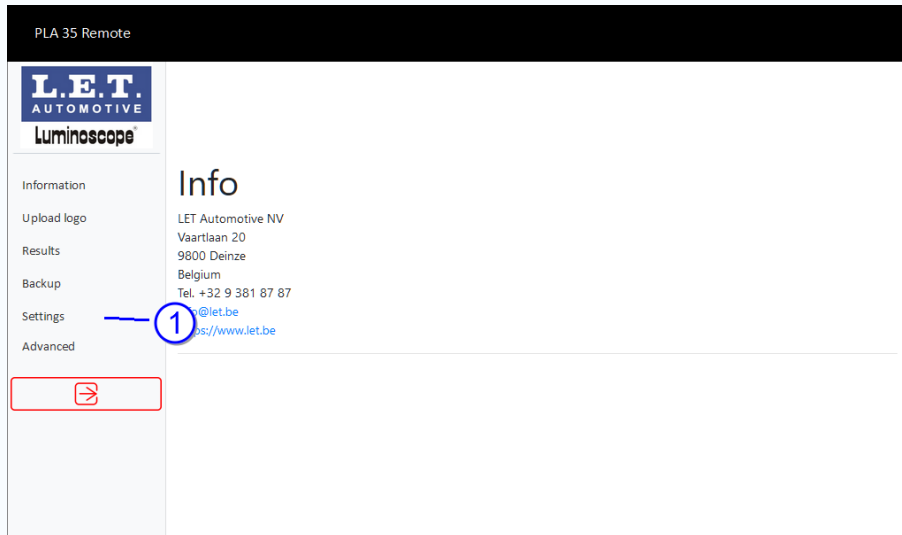

Figure 219: **Web interface main** screen in an authorized session

1. Click on the **Settings** link 1 on the **Web interface main** screen.

The following screen is now displayed:

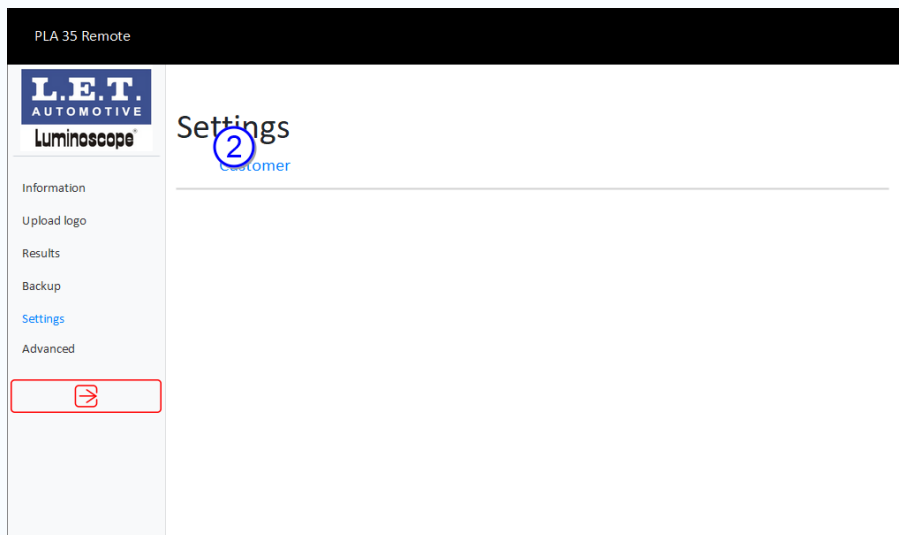

Figure 220: **Settings** screen

### Modify customer settings

2. Click on the **Customer** link 2 to access the **Customer settings** screen.

The following screen is now displayed:

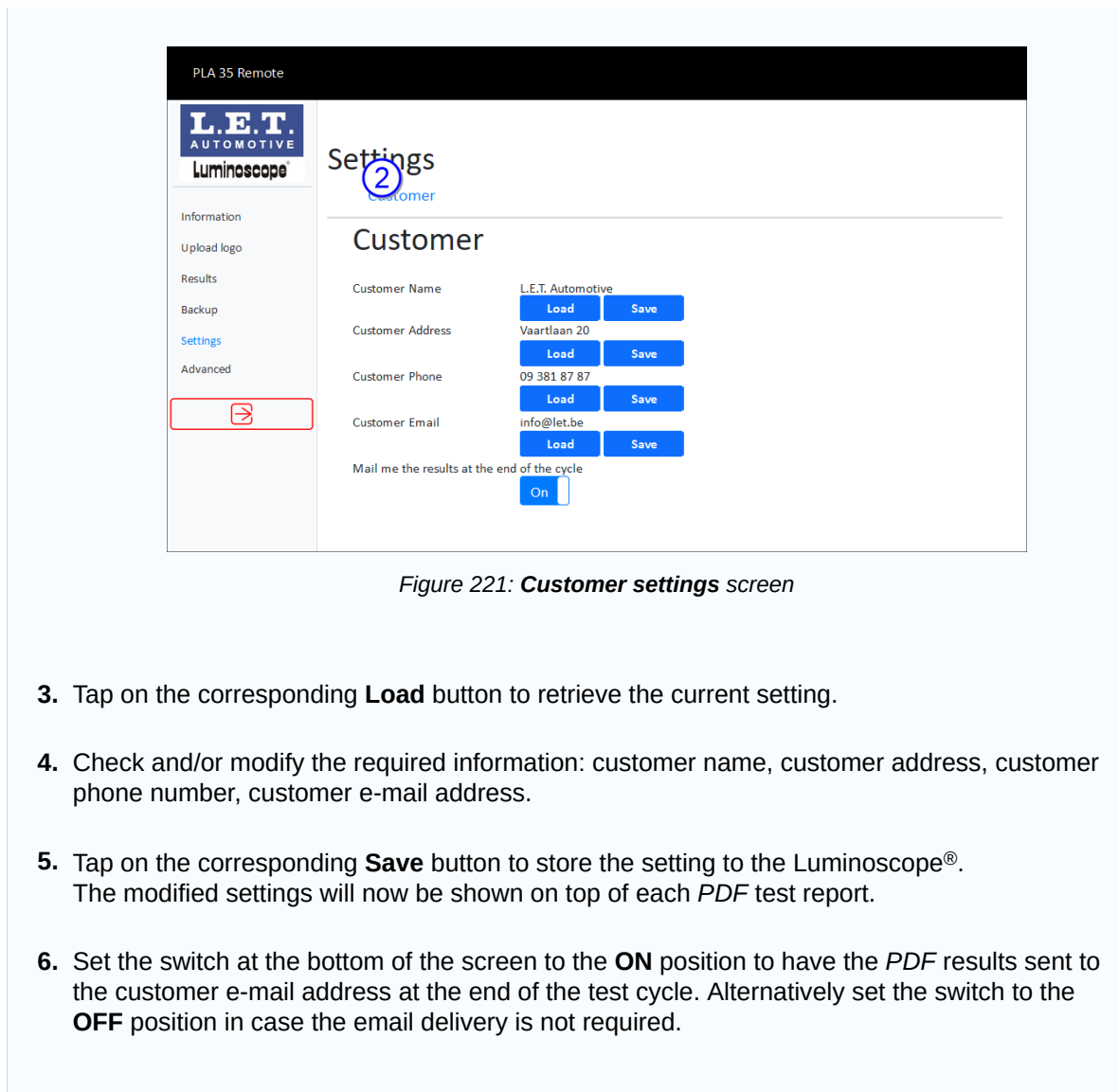

Figure 221: **Customer settings** screen

3. Tap on the corresponding **Load** button to retrieve the current setting.
4. Check and/or modify the required information: customer name, customer address, customer phone number, customer e-mail address.
5. Tap on the corresponding **Save** button to store the setting to the Luminoscope®. The modified settings will now be shown on top of each *PDF* test report.
6. Set the switch at the bottom of the screen to the **ON** position to have the *PDF* results sent to the customer e-mail address at the end of the test cycle. Alternatively set the switch to the **OFF** position in case the email delivery is not required.

## 12.6 Check stored info and remotely operate the Luminoscope®

This chapter explains how to access some stored info in the Luminoscope® such as log files, camera images and screenshots and how to remotely operate the Luminoscope®.

Starting from the **Web interface main** screen in an authorized session.

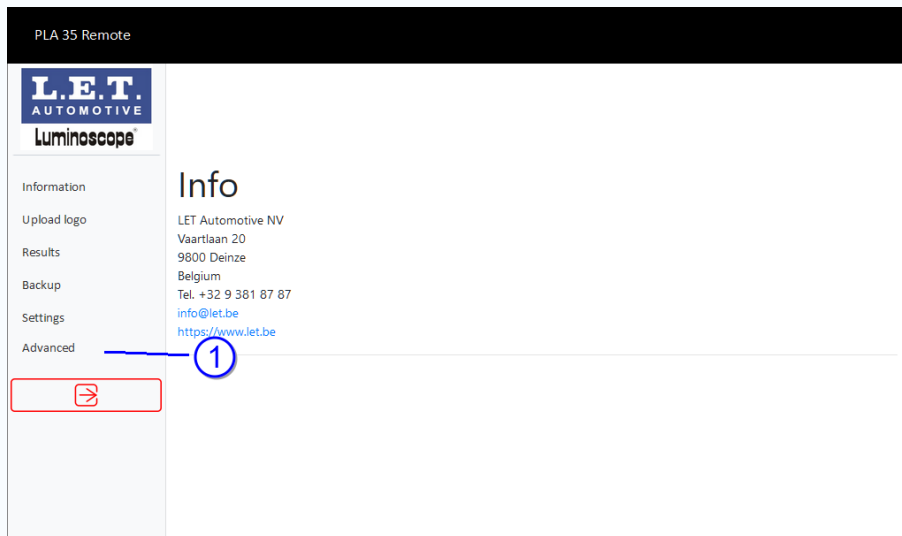

Figure 222: **Web interface main** screen in an authorized session

Click on the **Advanced** link 1 on the **Web interface main** screen.

The following screen is now displayed:

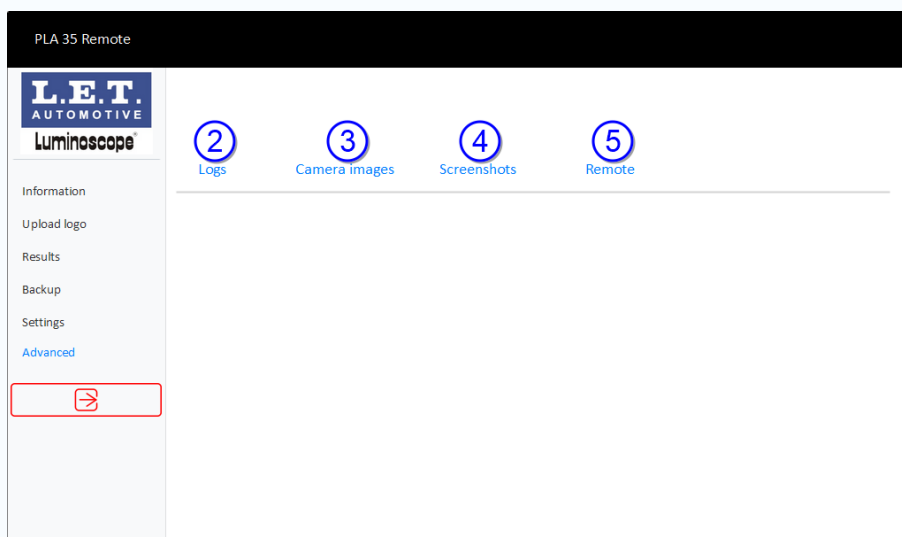

Figure 223: **Advanced** screen

The following options are available:

#	Element	Description
2	<b>Logs</b> link	Displays a list of all available log files in the Luminoscope®.
3	<b>Camera images</b> link	Displays a list of all available camera images in the Luminoscope®.
4	<b>Screenshots</b> link	Displays a list of all available screenshots in the Luminoscope®.
5	<b>Remote</b> link	Access to the remote operation of the Luminoscope®.

## 12.6.1 Access to log files

Log files in text format contain a number of timestamped lines describing events, related to the activity of the Luminoscope®. The information in these log files can be useful for tracking or diagnostic tasks. It may be interesting to store or archive them for future reference. The content of these log files is not intended to be used by regular users and is continuously generated.

Starting from the **Advanced** screen.

1. Click on the **Logs** link 2 on the **Advanced** screen to access the **Logs** screen.

The following screen is now displayed.

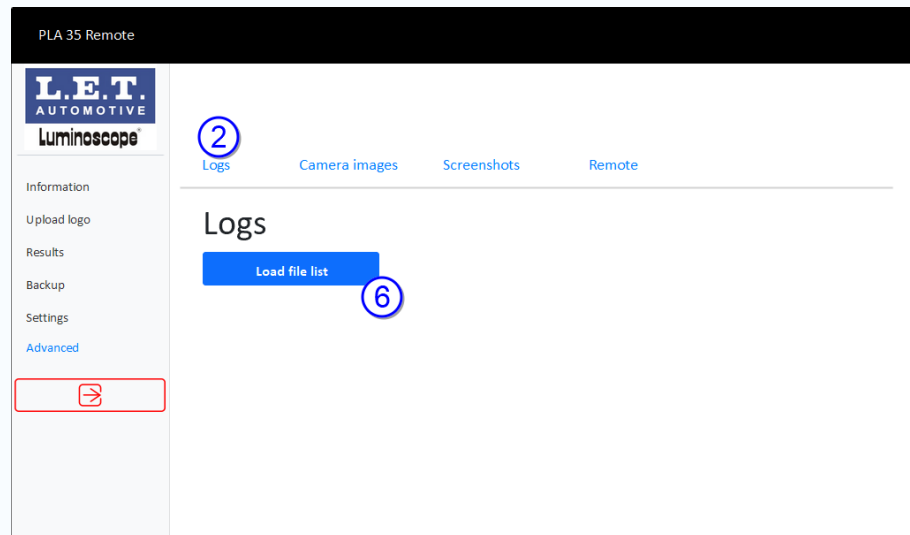

Figure 224: **Logs** screen

2. Tap on the **Load files list** button 6.

The following screen is displayed:

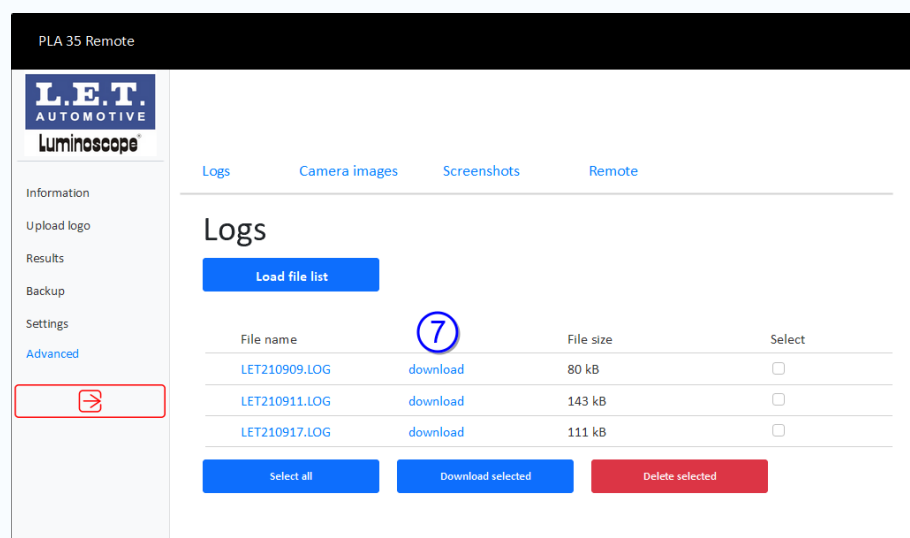

Figure 225: **Logs** screen with all available log files

The screen shows a list of all available log files. Each entry shows the date and time and the file size.

3. Click on the **Download** link 7 to download the log file. Alternatively tap on the log file name to open the log file.

The log file is now displayed in an extra tab page in the *web browser*.

## 12.6.2 Access to camera images

Each time the user taps on the *LET Automotive* logo on the touch screen of the user interface of the Luminoscope® while a headlamp projection is displayed, it simultaneously captures the camera projection and some diagnostic files. These camera images may be useful for future reference.

Starting from the **Advanced** screen.

1. Click on the **Camera images** link 3 on the **Advanced** screen to access the **Camera images** screen.

The following screen is now displayed.

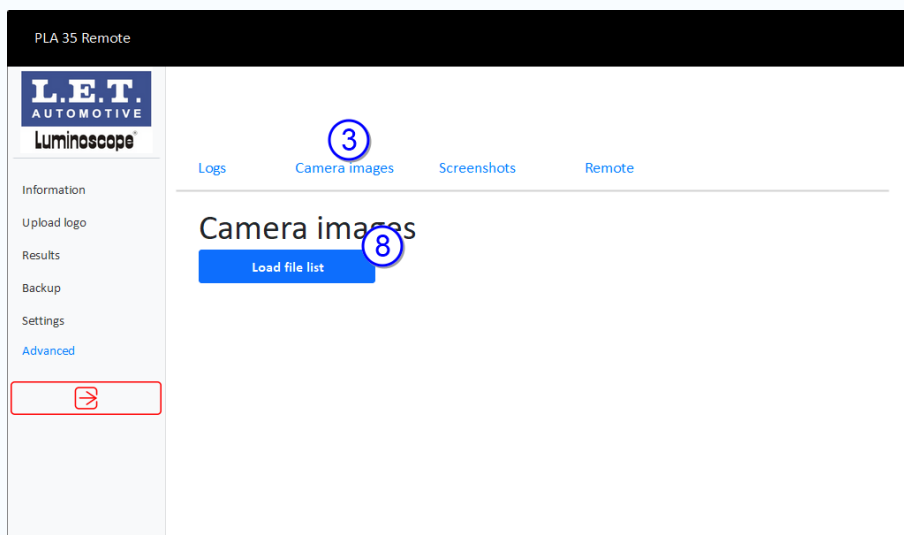

Figure 226: **Camera images** screen

2. Tap on the **Load files list** button 8.

The following screen is displayed:

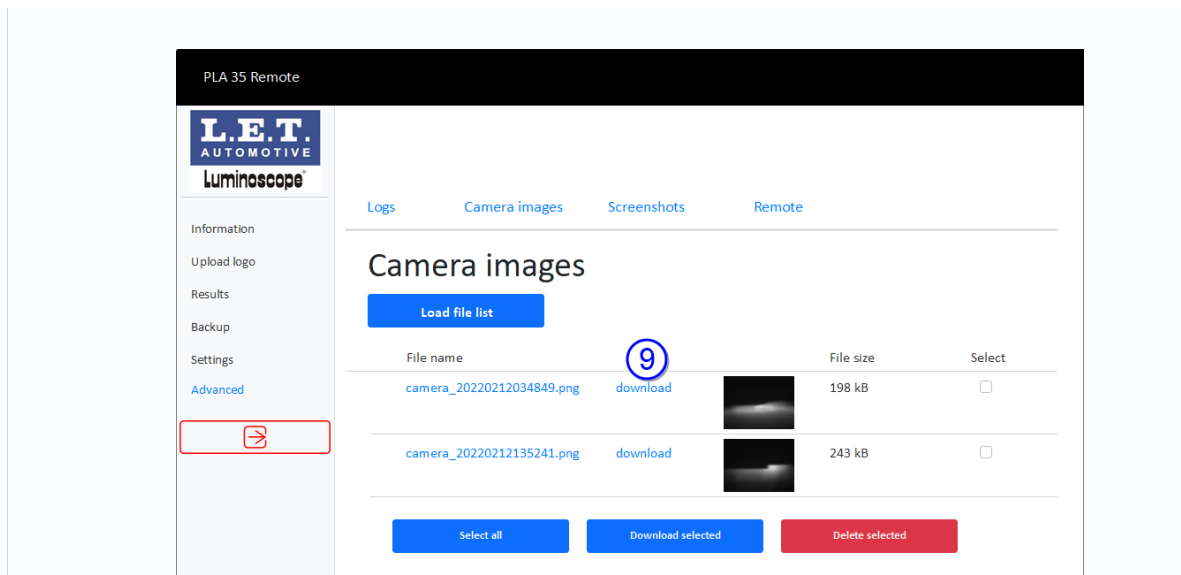

Figure 227: **Camera images** screen with all available camera images

The screen shows a list of all available camera images. Each entry shows the date and time and the file size.

3. Click on the **Download** link 9 to download the camera image. Alternatively tap on the camera image name to open the camera image.

The camera image is now displayed in an extra tab page in the *web browser*.

### 12.6.3 Access to screenshots

Each time the user taps on the *LET Automotive* logo on the touch screen, a screenshot of the current user interface of the Luminoscope® is captured simultaneously with some diagnostic files. These screenshots may be useful for future reference.

Starting from the **Advanced** screen.

1. Click on the **Screenshots** link 4 on the **Web interface main** screen.

The following screen is now displayed:

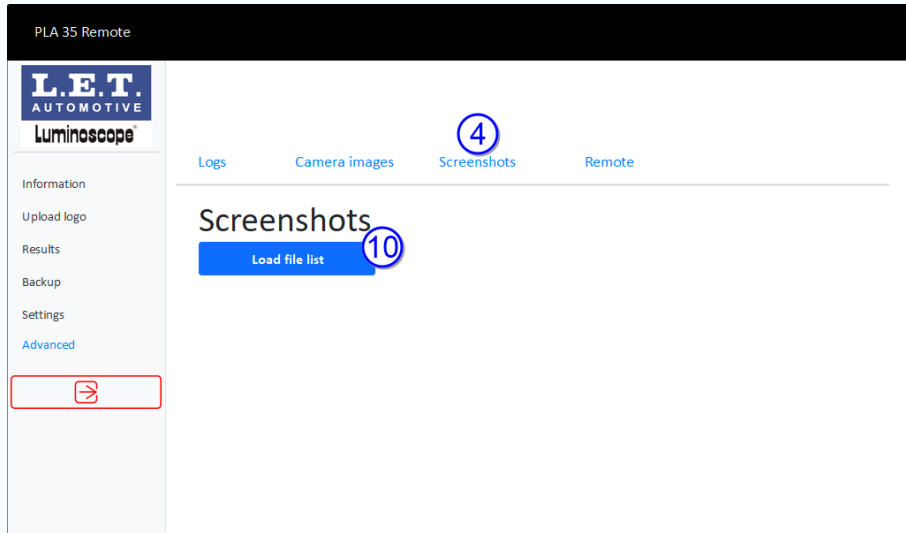

Figure 228: **Screenshots** screen

2. Tap on the **Load files list** button 10.  
The following screen is displayed:

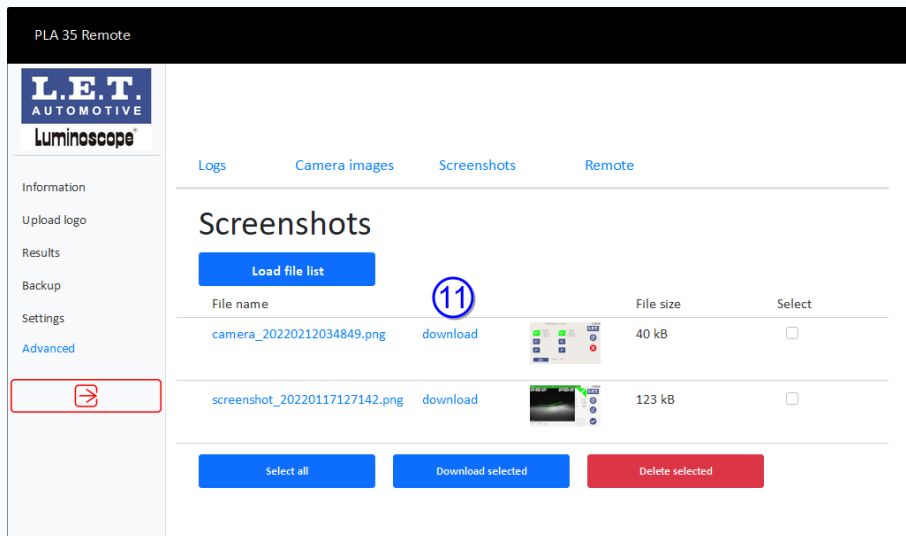

Figure 229: **Screenshots** screen with all available screenshots

The screen displays a list of all available screenshots. Each entry shows the date and time and the file size.

3. Click on the **Download** link 11 to download the screenshot. Alternatively tap on the screenshot name to open the screenshot.  
The selected screenshot is now displayed in an extra tab page in the *web browser*.

## 12.6.4 Access to remote Luminoscope® screen

Starting from the **Advanced** screen.

1. Click on the **Remote** link 5 on the **Advanced** screen to open an extra tab page in the *web browser* showing a duplicate of the Luminoscope® screen.

The following screen is now displayed:

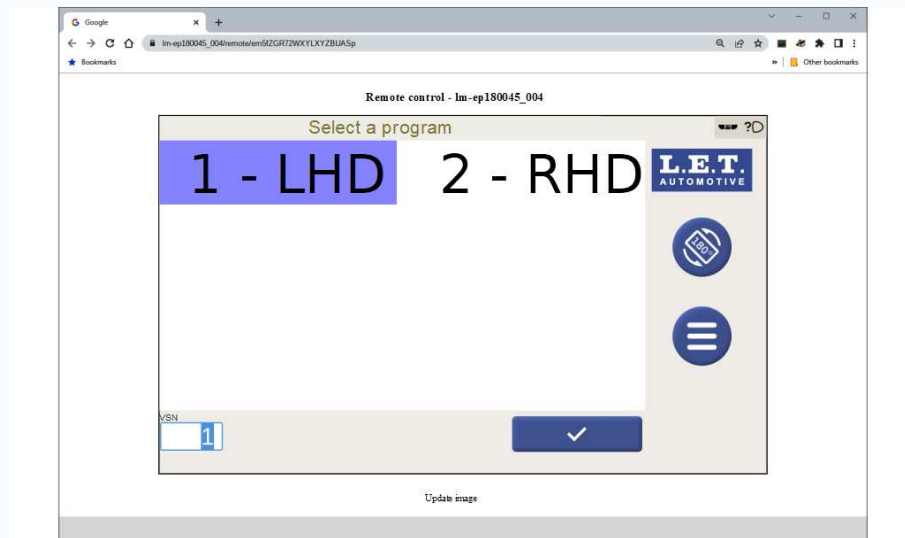

Figure 230: **Remote Luminoscope** screen

The Luminoscope® can now be remotely controlled.

2. Close the **Remote control** tab page to terminate the remote view.













**Luminoscope®**

**LET Automotive NV**

Vaartlaan 20  
9800 Deinze  
Belgium

 +32 9 381 87 87

 info@let.be

 www.let.be

Learn more in our product website

<https://luminoscope.be>



Find more information in the full user manual

<https://qr-support.luminoscope.be>

